



**Washington State
Department of Transportation**

Materials Manual

M 46-01.42

January 2023

Engineering and Regional Operations
State Materials Laboratory

ENGLISH

Title VI Notice to Public

It is the Washington State Department of Transportation's (WSDOT) policy to assure that no person shall, on the grounds of race, color, national origin, as provided by Title VI of the Civil Rights Act of 1964, be excluded from participation in, be denied the benefits of, or be otherwise discriminated against under any of its programs and activities. Any person who believes his/her Title VI protection has been violated, may file a complaint with WSDOT's Office of Equity and Civil Rights (OECR). For additional information regarding Title VI complaint procedures and/or information regarding our non-discrimination obligations, please contact OECR's Title VI Coordinator at 360-705-7090.

Americans with Disabilities Act (ADA) Information

This material can be made available in an alternate format by emailing the Office of Equity and Civil Rights at wsdotada@wsdot.wa.gov or by calling toll free, 855-362-4ADA(4232). Persons who are deaf or hard of hearing may make a request by calling the Washington State Relay at 711.

ESPAÑOL

Notificación de Título VI al Público

La política del Departamento de Transporte del Estado de Washington (Washington State Department of Transportation, WSDOT) es garantizar que ninguna persona, por motivos de raza, color u origen nacional, según lo dispuesto en el Título VI de la Ley de Derechos Civiles de 1964, sea excluida de la participación, se le nieguen los beneficios o se le discrimine de otro modo en cualquiera de sus programas y actividades. Cualquier persona que considere que se ha violado su protección del Título VI puede presentar una queja ante la Oficina de Equidad y Derechos Civiles (Office of Equity and Civil Rights, OECR) del WSDOT. Para obtener más información sobre los procedimientos de queja del Título VI o información sobre nuestras obligaciones contra la discriminación, comuníquese con el coordinador del Título VI de la OECR al 360-705-7090.

Información de la Ley sobre Estadounidenses con Discapacidades (ADA, por sus siglas en inglés)

Este material puede estar disponible en un formato alternativo al enviar un correo electrónico a la Oficina de Equidad y Derechos Civiles a wsdotada@wsdot.wa.gov o llamando a la línea sin cargo 855-362-4ADA(4232). Personas sordas o con discapacidad auditiva pueden solicitar la misma información llamando al Washington State Relay al 711.

한국어 - KOREAN

제6조 관련 공지사항

워싱턴 주 교통부(WSDOT)는 1964년 민권법 타이틀 VI 규정에 따라, 누구도 인종, 피부색 또는 출신 국가를 근거로 본 부서의 모든 프로그램 및 활동에 대한 참여가 배제되거나 혜택이 거부되거나, 또는 달리 차별받지 않도록 하는 것을 정책으로 하고 있습니다. 타이틀 VI에 따른 그/그녀에 대한 보호 조항이 위반되었다고 생각된다면 누구든지 WSDOT의 평등 및 민권 사무국(OECR)에 민원을 제기할 수 있습니다. 타이틀 VI에 따른 민원 처리 절차에 관한 보다 자세한 정보 및/또는 본 부서의 차별금지 의무에 관한 정보를 원하신다면, 360-705-7090으로 OECR의 타이틀 VI 담당자에게 연락해주시십시오.

미국 장애인법(ADA) 정보

본 자료는 또한 평등 및 민권 사무국에 이메일 wsdotada@wsdot.wa.gov 을 보내시거나 무료 전화 855-362-4ADA(4232)로 연락하셔서 대체 형식으로 받아보실 수 있습니다. 청각 장애인은 워싱턴주 중계 711로 전화하여 요청하실 수 있습니다.

русский - RUSSIAN

Раздел VI Общественное заявление

Политика Департамента транспорта штата Вашингтон (WSDOT) заключается в том, чтобы исключить любые случаи дискриминации по признаку расы, цвета кожи или национального происхождения, как это предусмотрено Разделом VI Закона о гражданских правах 1964 года, а также случаи недопущения участия, лишения льгот или другие формы дискриминации в рамках любой из своих программ и мероприятий. Любое лицо, которое считает, что его средства защиты в рамках раздела VI были нарушены, может подать жалобу в Ведомство по вопросам равенства и гражданских прав WSDOT (OECR). Для дополнительной информации о процедуре подачи жалобы на несоблюдение требований раздела VI, а также получения информации о наших обязательствах по борьбе с дискриминацией, пожалуйста, свяжитесь с координатором OECR по разделу VI по телефону 360-705-7090.

Закон США о защите прав граждан с ограниченными возможностями (ADA)

Эту информацию можно получить в альтернативном формате, отправив электронное письмо в Ведомство по вопросам равенства и гражданских прав по адресу wsdotada@wsdot.wa.gov или позвонив по бесплатному телефону 855-362-4ADA(4232). Глухие и слабослышащие лица могут сделать запрос, позвонив в специальную диспетчерскую службу штата Вашингтон по номеру 711.(4232). Глухие и слабослышащие лица могут сделать запрос, позвонив в специальную диспетчерскую службу штата Вашингтон по номеру 711.

tiếng Việt - VIETNAMESE

Thông báo Khoản VI dành cho công chúng

Chính sách của Sở Giao Thông Vận Tải Tiểu Bang Washington (WSDOT) là bảo đảm không để cho ai bị loại khỏi sự tham gia, bị từ khước quyền lợi, hoặc bị kỳ thị trong bất cứ chương trình hay hoạt động nào vì lý do chủng tộc, màu da, hoặc nguồn gốc quốc gia, theo như quy định trong Mục VI của Đạo Luật Dân Quyền năm 1964. Bất cứ ai tin rằng quyền bảo vệ trong Mục VI của họ bị vi phạm, đều có thể nộp đơn khiếu nại cho Văn Phòng Bảo Vệ Dân Quyền và Bình Đẳng (OECR) của WSDOT. Muốn biết thêm chi tiết liên quan đến thủ tục khiếu nại Mục VI và/hoặc chi tiết liên quan đến trách nhiệm không kỳ thị của chúng tôi, xin liên lạc với Phó Trí Viên Mục VI của OECR số 360-705-7090.

Thông tin về Đạo luật Người Mỹ tàn tật (Americans with Disabilities Act, ADA)

Tài liệu này có thể thực hiện bằng một hình thức khác bằng cách email cho Văn Phòng Bảo Vệ Dân Quyền và Bình Đẳng wsdotada@wsdot.wa.gov hoặc gọi điện thoại miễn phí số, 855-362-4ADA(4232). Người điếc hoặc khiếm thính có thể yêu cầu bằng cách gọi cho Dịch vụ Tiếp âm Tiểu bang Washington theo số 711.

العربية - ARABIC

العنوان 6 إشعار للجمهور

تتمثل سياسة وزارة النقل في ولاية واشنطن (WSDOT) في ضمان عدم استبعاد أي شخص، على أساس العرق أو اللون أو الأصل القومي من المشاركة في أي من برامجها وأنشطتها أو الحرمان من الفوائد المتاحة بموجبها أو التعرض للتمييز فيها بخلاف ذلك، كما هو منصوص عليه في الباب السادس من قانون الحقوق المدنية لعام 1964. ويمكن لأي شخص يعتقد أنه تم انتهاك حقوقه التي يكفلها الباب السادس تقديم شكوى إلى مكتب المساواة والحقوق المدنية (OECR) التابع لوزارة النقل في ولاية واشنطن. للحصول على معلومات إضافية بشأن إجراءات الشكاوى وأو بشأن التزاماتنا بعدم التمييز بموجب الباب السادس، يرجى الاتصال بمنسق الباب السادس في مكتب المساواة والحقوق المدنية على الرقم 360-705-7090.

معلومات قانون الأمريكيين ذوي الإعاقة (ADA)

يمكن توفير هذه المواد في تنسيق بديل عن طريق إرسال رسالة بريد إلكتروني إلى مكتب المساواة والحقوق المدنية على wsdotada@wsdot.wa.gov أو عن طريق الاتصال بالرقم المجاني: 855-362-4ADA (4232). يمكن للأشخاص الصم أو ضعاف السمع تقديم طلب عن طريق الاتصال بخدمة Washington State Relay على الرقم 711.

中文 - CHINESE

《权利法案》Title VI公告

<華盛頓州交通部(WSDOT)政策規定，按照《1964年民權法案》第六篇規定，確保無人因種族、膚色或國籍而被排除在WSDOT任何計畫和活動之外，被剝奪相關權益或以其他方式遭到歧視。如任何人認為其第六篇保護權益遭到侵犯，則可向WSDOT的公平和民權辦公室(OECR)提交投訴。如需關於第六篇投訴程式的更多資訊和/或關於我們非歧視義務的資訊，請聯絡OECR的第六篇協調員，電話360-705-7090。

《美国残疾人法案》(ADA)信息

可向公平和民權辦公室發送電子郵件wsdotada@wsdot.wa.gov或撥打免費電話 855-362-4ADA(4232)，以其他格式獲取此資料。听力丧失或听觉障碍人士可拨打711联系Washington州转接站。

Af-soomaaliga - SOMALI

Ciwaanka VI Ogeysiiska Dadweynaha

Waa siyaasada Waaxda Gaadiidka Gobolka Washington (WSDOT) in la xaqiijiy in aan qofna, ayadoo la cuskanaayo sababo la xariira isir, midab, ama wadanku kasoo jeedo, sida ku qoran Title VI (Qodobka VI) ee Sharciga Xaquuqda Madaniga ah ah oo soo baxay 1964, laga saarin ka qaybgalka, loo diidin faa'iidooyinka, ama si kale loogu takoorin barnaamijyadeeda iyo shaqooyinkeeda. Qof kasta oo aaminsan in difaaciisa Title VI la jebiyay, ayaa cabasho u gudbin kara Xafiiska Sinaanta iyo Xaquuqda Madaniga ah (OECR) ee WSDOT. Si aad u hesho xog dheeraad ah oo ku saabsan hanaannada cabashada Title VI iyo/ama xogta la xariirta waajibbaadkeena ka caagan takoorka, fadlan la xariir Iskuduwaha Title VI ee OECR oo aad ka wacayso 360-705-7090.

Macluumaadka Xeerka Naafada Marykanka (ADA)

Agabkaan ayaad ku heli kartaa qaab kale adoo iimeel u diraa Xafiiska Sinaanta iyo Xaquuqda Madaniga ah oo aad ka helayso wsdotada@wsdot.wa.gov ama adoo wacaaya laynka bilaashka ah, 855-362-4ADA(4232). Dadka naafada maqalka ama maqalku ku adag yahay waxay ku codsan karaan wicitaanka Adeega Gudbinta Gobolka Washington 711.

If you have difficulty understanding English, you may, free of charge, request language assistance services by calling 360-709-5412 or email us at: Kevin.Burns@wsdot.wa.gov

ESPAÑOL – SPANISH

Servicios de traducción

Aviso a personas con dominio limitado del idioma inglés: Si usted tiene alguna dificultad en entender el idioma inglés, puede, sin costo alguno, solicitar asistencia lingüística con respecto a esta información llamando al 360-709-5412, o envíe un mensaje de correo electrónico a: Kevin.Burns@wsdot.wa.gov

한국어 – KOREAN

번역 서비스

영어로 소통하는 것이 불편하시다면 360-709-5412, 으로 전화하시거나 다음 이메일로 연락하셔서 무료 언어 지원 서비스를 요청하실 수 있습니다: Kevin.Burns@wsdot.wa.gov

русский – RUSSIAN

Услуги перевода

Если вам трудно понимать английский язык, вы можете запросить бесплатные языковые услуги, позвонив по телефону 360-709-5412, или написав нам на электронную почту: Kevin.Burns@wsdot.wa.gov

tiếng Việt – VIETNAMESE

các dịch vụ dịch thuật

Nếu quý vị không hiểu tiếng Anh, quý vị có thể yêu cầu dịch vụ trợ giúp ngôn ngữ, miễn phí, bằng cách gọi số 360-709-5412, hoặc email cho chúng tôi tại: Kevin.Burns@wsdot.wa.gov

العَرَبِيَّةُ – ARABIC

خدمات الترجمة

إذا كنت تجد صعوبة في فهم اللغة الإنجليزية، فيمكنك مجاناً طلب خدمات المساعدة اللغوية عن طريق الاتصال بالرقم 360-709-5412 أو مراسلتنا عبر البريد الإلكتروني : Kevin.Burns@wsdot.wa.gov

中文 – CHINESE

翻译服务

如果您难以理解英文，则请致电：360-709-5412，或给我们发送电子邮件：Kevin.Burns@wsdot.wa.gov，请求获取免费语言援助服务。

Af-soomaaliga – SOMALI

Adeegyada Turjumaada

Haddii ay kugu adag tahay inaad fahamtid Ingiriisida, waxaad, bilaash, ku codsan kartaa adeegyada caawimada luuqada adoo wacaaya 360-709-5412 ama iimayl noogu soo dir: Kevin.Burns@wsdot.wa.gov

Foreword

The *Materials Manual* continues to use AASHTO, ASTM, WAQTC, and WSDOT test methods. The strategic direction for the Materials Laboratory is to continue to expand the use of AASHTO and ASTM standards whenever possible.

The manual has retained its dual unit format. However, English units predominate with metric units in parenthesis. WSDOT is using English units. The manual reflects the Quality System concerns of an AASHTO accredited organization and is organized by numerical test order. It also features two contents and an index.

The manual reflects a continuing policy of adopting “consensus” standards wherever practical. Adoption of these, in the form of AASHTO, ASTM, WAQTC, or other nationally recognized standards eliminates much of the previous text, which merely recopied the national documents. By adopting these standards, we provide a common standard that can be used by neighboring states and other laboratories or organizations. Contractors who work in more than one state also benefit by having to conform with fewer unique tests.

The concept of Field Operating Procedures (FOP) is continued to support the work of Materials Testers at the Field or Project level. Full procedures are provided when WSDOT Test Methods apply, or when a consensus standard (AASHTO, ASTM, or WAQTC) has been adapted to an FOP. The FOP provides the essential performance elements for the field technician.

When not specified by the test procedure, test reports will be generated through the Materials Testing System (MATS) or by the use of forms approved by the State Materials Engineer.

The WSDOT Materials Laboratory is responsible for establishing and managing all test procedures. For technical information or suggested changes to test methods or procedures, contact the WSDOT Materials Laboratory Quality Systems Manager through the departmental mail system at MS 47365; by mail at PO Box 47365, Olympia, WA 98504-7365; by email at mawdslr@wsdot.wa.gov; by telephone at 360-709-5497; or by fax at 360-709-5588, physically located at 1655 South Second Avenue, Tumwater, WA 98512. Please use this physical address for all communications other than U.S. Postal Service mail.

This manual is updated as needed. To order printed copies, go to:

www.wsdot.wa.gov/publications/manuals/orderinformation.htm

To view electronic copies, go to:

www.wsdot.wa.gov/publications/manuals/m46-01.htm

Kurt R. Williams, P.E.
State Materials Engineer

Aggregate				
Procedure Number	Owner	Field Use	In Manual	Test Method
T 11	AASHTO			Materials Finer Than 0.075 mm (No. 200) Sieve in Mineral Aggregates by Washing
T 19	AASHTO	✓	✓	Bulk Density (“Unit Weight”) and Voids in Aggregate (Rodding Procedure Only) (Checklist Only)
T 21	AASHTO			Organic Impurities in Fine Aggregates for Concrete
T 27	AASHTO			Sieve Analysis of Fine and Coarse Aggregates
T 27_T 11	WAQTC	✓	✓	FOP for AASHTO T 27_T 11, Sieve Analysis of Fine and Coarse Aggregates
T 37	AASHTO			Sieve Analysis of Mineral Filler for Hot Mix Asphalt (HMA)
R 76	AASHTO			Reducing Samples of Aggregate to Testing Size
R 76	WAQTC	✓	✓	FOP for AASHTO R 76, Reducing Samples of Aggregate to Testing Size
T 84	AASHTO			Specific Gravity and Absorption of Fine Aggregates
T 85	AASHTO			Specific Gravity and Absorption of Coarse Aggregate
T 85	WAQTC	✓	✓	FOP for AASHTO T 85, Specific Gravity and Absorption of Coarse Aggregate
R 90	AASHTO			Sampling Aggregate Products
R 90	WAQTC	✓	✓	FOP for AASHTO R 90, Sampling Aggregate Products
T 96	AASHTO			Resistance to Degradation of Small-Size Coarse Aggregate by Abrasion and Impact in the Los Angeles Machine
T 112	AASHTO		✓	Clay Lumps and Friable Particles in Aggregate
T 113	WSDOT		✓	Method of Test for Determination of Degradation Value
T 123	WSDOT	✓	✓	Method of Test for Bark Mulch
T 125	WSDOT		✓	Determination of Fiber Length Percentages in Wood Strand Mulch
T 126	WSDOT		✓	Determination of Fiber Length Percentages in Hydraulically-Applied Erosion Control Products
SOP 128	WSDOT	✓	✓	Sampling for Aggregate Source Approval
T 176	AASHTO			Plastic Fines in Graded Aggregates and Soils by Use of the Sand Equivalent Test
T 176	WAQTC	✓	✓	FOP for AASHTO T 176, Plastic Fines in Graded Aggregates and Soils by the Use of the Sand Equivalent Test
T 255	AASHTO			Total Evaporable Moisture Content of Aggregate by Drying
T 255	WAQTC	✓	✓	FOP for AASHTO T 255, Total Evaporable Moisture Content of Aggregate by Drying
T 288	AASHTO		✓	Determining Minimum Laboratory Soil Resistivity (Checklist Only)
T 289	AASHTO			Determining pH of Soil for Use in Corrosion Testing
T 304	AASHTO			Uncompacted Void Content of Fine Aggregate
T 304	WAQTC	✓	✓	FOP for AASHTO T 304, Uncompacted Void Content of Fine Aggregate
T 335	AASHTO			Determining the Percentage of Fracture in Coarse Aggregate
T 335	WAQTC	✓	✓	FOP for AASHTO T 335, Determining the Percentage of Fracture in Coarse Aggregate
T 417	WSDOT		✓	Method of Test for Determining Minimum Resistivity and pH of Soil and Water
T 716	WSDOT	✓	✓	Method of Random Sampling for Locations of Testing and Sampling Sites

Bituminous Cement				
Procedure Number	Owner	Field Use	In Manual	Test Method
R 28	AASHTO			Standard Practice for Accelerated Aging of Asphalt Binder Using a Pressurized Aging Vessel
R 29	AASHTO			Standard Practice for Grading or Verifying the Performance Grade (PG) of an Asphalt Binder
T 44	AASHTO			Solubility of Bituminous Materials
T 48	AASHTO			Flash and Fire Points by Cleveland Open Cup
T 49	AASHTO			Penetration of Bituminous Materials
T 50	AASHTO			Float Test for Bituminous Materials
T 51	AASHTO			Ductility of Asphalt Materials
T 53	AASHTO			Softening Point of Bitumen (Ring-and-Ball Apparatus)
T 59	AASHTO			Emulsified Asphalts
R 66	AASHTO			Sampling Asphalt Materials
R 66	WAQTC	✓	✓	FOP for AASHTO R 66, Sampling Asphalt Materials
E 70	ASTM			pH of Aqueous Solutions With the Glass Electrode
T 72	AASHTO			Saybolt Viscosity
T 228	AASHTO			Specific Gravity of Semi-Solid Asphalt Materials
T 240	AASHTO			Effect of Heat and Air on a Moving Film of Asphalt Binder (Rolling Thin-Film Oven Test)
T 301	AASHTO			Elastic Recovery Test of Asphalt Materials by Means of a Ductilometer
T 313	AASHTO			Determining the Flexural Creep Stiffness of Asphalt Binder Using the Bending Beam Rheometer (BBR)
T 315	AASHTO			Determining the Rheological Properties of Asphalt Binder Using a Dynamic Shear Rheometer (DSR)
T 316	AASHTO			Viscosity Determination of Asphalt Binder Using Rotational Viscometer
SOP 318	WSDOT		✓	Standard Operating Procedure for Melting of Flexible Bituminous Pavement Marker Adhesive for Evaluation
T 350	AASHTO			Multiple Stress Creep Recovery (MSCR) Test of Asphalt Binder Using a Dynamic Shear Rheometer (DSR)
T 426	WSDOT		✓	Pull-Off Test for Hot Melt Traffic Button Adhesive
D 3111	ASTM			Flexibility Determination of Hot-Melt Adhesives by Mandrel Bend Test Method

Asphalt Mixture				
Procedure Number	Owner	Field Use	In Manual	Test Method
R 30	AASHTO			Standard Practice for Mixture Conditioning of Hot Mix Asphalt (HMA)
T 30	AASHTO			Mechanical Analysis of Extracted Aggregate
T 30	WAQTC	✓	✓	FOP for AASHTO T 30, Mechanical Analysis of Extracted Aggregate
TM 13	WAQTC		✓	Volumetric Properties of Asphalt Mixtures
TM 14	WAQTC		✓	Laboratory Prepared Asphalt Mixture Specimens
T 37	AASHTO			Sieve Analysis of Mineral Filler of Hot Mix Asphalt (HMA)
R 47	AASHTO			Reducing Samples of Asphalt Mixtures to Testing Size
R 47	WAQTC	✓	✓	FOP for AASHTO R 47, Reducing Samples of Asphalt Mixtures to Testing Size
R 79	AASHTO			Vacuum Drying Compacted Asphalt Specimens
R 79	WAQTC	✓	✓	FOP for AASHTO R 79, Vacuum Drying Compacted Asphalt Specimens
R 96	AASHTO			Installation, Operation, and Maintenance of Ignition Furnaces
R 97	AASHTO			Sampling Asphalt Mixtures

Asphalt Mixture				
Procedure Number	Owner	Field Use	In Manual	Test Method
R 97	WAQTC	✓	✓	FOP for AASHTO R 97, Sampling Asphalt Mixtures
T 166	AASHTO			Bulk Specific Gravity (G_{mb}) of Compacted Asphalt Mixtures Using Saturated Surface-Dry Specimens
T 166	WAQTC	✓	✓	FOP for AASHTO T 166, Bulk Specific Gravity (G_{mb}) of Compacted Asphalt Mixtures Using Saturated Surface-Dry Specimens
T 209	AASHTO			Theoretical Maximum Specific Gravity (G_{mm}) and Density of Asphalt Mixtures
T 209	WAQTC	✓	✓	FOP for AASHTO T 209, Theoretical Maximum Specific Gravity (G_{mm}) and Density of Asphalt Mixtures
T 269	AASHTO			Percent Air Void in Compacted Dense and Open Asphalt Mixtures
T 308	AASHTO			Determining the Asphalt Binder Content of Asphalt Mixtures by the Ignition Method
T 308	WAQTC	✓	✓	FOP for AASHTO T 308, Determining the Asphalt Binder Content of Asphalt Mixtures by the Ignition Method
T 312	AASHTO			Preparing and Determining the Density of Asphalt Mixture Specimens by Means of the Superpave Gyratory Compactor
T 312	WSDOT	✓	✓	FOP for AASHTO T 312, Preparing and Determining the Density of Asphalt Mixture Specimens by Means of the Superpave Gyratory Compactor
T 324	AASHTO		✓	Hamburg Wheel-Track Testing of Compacted Asphalt Mixtures
T 329	AASHTO			Moisture Content of Asphalt Mixtures by Oven Method
T 329	WAQTC	✓	✓	FOP for AASHTO T 329, Moisture Content of Asphalt Mixtures by Oven Method
T 331	AASHTO			Bulk Specific Gravity (G_{mb}) and Density of Compacted Asphalt Mixtures Using Automatic Vacuum Sealing Method
T 331	WAQTC	✓	✓	FOP for AASHTO T 331, Bulk Specific Gravity (G_{mb}) and Density of Compacted Asphalt Mixtures Using Automatic Vacuum Sealing Method
T 355	AASHTO			In-Place Density of Asphalt Mixtures by Nuclear Methods
T 355	WAQTC	✓	✓	FOP for AASHTO T 355, In-Place Density of Asphalt Mixtures by Nuclear Methods
T 716	WSDOT	✓	✓	Method of Random Sampling for Locations of Testing and Sampling Sites
T 720	WSDOT		✓	Method of Test for Thickness Measurement of Hot Mix Asphalt (HMA) Cores
SOP 729	WSDOT	✓	✓	Standard Operating Procedure for Determination of the Moving Average of Theoretical Maximum Density (TMD) for HMA
SOP 730	WSDOT	✓	✓	Standard Operating Procedure for Correlation of Nuclear Gauge Densities With Hot Mix Asphalt (HMA) Cores
SOP 731	WSDOT	✓	✓	Standard Operating Procedure for Determining Volumetric Properties of Hot Mix Asphalt
SOP 732	WSDOT	✓	✓	Standard Operating Procedure for Volumetric Design for Hot-Mix Asphalt (HMA)
SOP 733	WSDOT	✓	✓	Standard Operating Procedure for Determination of Pavement Density Differentials Using the Nuclear Density Gauge
SOP 734	WSDOT	✓	✓	Standard Operating Procedure for Sampling Hot Mix Asphalt After Compaction (Obtaining Cores)
SOP 735	WSDOT	✓	✓	Standard Operating Procedure for Longitudinal Joint Density
SOP 736	WSDOT		✓	In-Place Density of Bituminous Mixes Using Cores
SOP 737	WSDOT		✓	Procedure for the Forensic Testing of HMA Field Cores
D 6931	ASTM		✓	Indirect Tensile (IDT) Strength of Asphalt Mixtures

Cement				
Procedure Number	Owner	Field Use	In Manual	Test Method
R 71	AASHTO			Sampling and Amount of Testing of Hydraulic Cement
T 105	AASHTO			Chemical Analysis of Hydraulic Cement
T 106	AASHTO			Compressive Strength of Hydraulic Cement Mortars (Using 50-mm or 2-in. Cube Specimens)
T 106	WSDOT	✓	✓	FOP for AASHTO for Compressive Strength of Hydraulic Cement Mortars (Using 2-in. or (50-mm) Cube Specimens)
T 107	AASHTO			Autoclave Expansion of Hydraulic Cement
T 129	AASHTO			Amount of Water Required for Normal Consistency of Hydraulic Cement Paste
T 131	AASHTO			Time of Setting of Hydraulic Cement by Vicat Needle
T 133	AASHTO			Density of Hydraulic Cement
T 137	AASHTO			Air Content of Hydraulic Cement Mortar
T 153	AASHTO			Fineness of Hydraulic Cement by Air Permeability Apparatus
T 162	AASHTO			Mechanical Mixing of Hydraulic Cement Pastes and Mortars of Plastic Consistency
T 192	AASHTO			Fineness of Hydraulic Cement by the 45- μ m (No. 325) Sieve
M 201	AASHTO			Mixing Rooms, Moist Cabinets, Moist Rooms, and Water Storage Tanks Used in the Testing of Hydraulic Cements and Concretes
T 260	AASHTO			Sampling and Testing for Chloride Ion in Concrete and Concrete Raw Materials
T 303	AASHTO			Accelerated Detection of Potentially Deleterious Expansion of Mortar Bars Due to Alkali-Silica Reaction
T 313	WSDOT		✓	Method of Test for Cement-Latex Compatibility
T 314	WSDOT		✓	Method of Test for Photovolt Reflectance
T 413	WSDOT		✓	Method of Test for Evaluating Waterproofing Effectiveness of Membrane and Membrane-Pavement Systems
T 813	WSDOT	✓	✓	Field Method of Fabrication of 2 in (50 mm) Cube Specimens for Compressive Strength Testing of Grouts and Mortars
T 814	WSDOT		✓	Method of Test for Water Retention Efficiency of Liquid Membrane-Forming Compounds and Impermeable Sheet Materials for Curing Concrete
C 939	WSDOT	✓	✓	FOP for ASTM for Flow of Grout for Preplaced-Aggregate Concrete (Flow Cone Method)

Chemical				
Procedure Number	Owner	Field Use	In Manual	Test Method
LRFD CONS	AASHTO			Section 18, Bearing Devices
M 111	AASHTO			Zinc (Hot-Dip Galvanized) Coatings on Iron and Steel Products
M 251	AASHTO			Plain and Laminated Elastomeric Bridge Bearings
T 65	AASHTO			Mass (Weight) of Coating on Iron and Steel Articles With Zinc or Zinc-Alloy Coatings
T 105/ C114	AASHTO			Chemical Analysis of Hydraulic Cement
T 260	AASHTO			Sampling and Testing for Chloride Ion in Concrete and Concrete Raw Materials
T 267	AASHTO			Determination of Organic Content in Soils by Loss on Ignition
C 109	ASTM			Compressive Strength of Hydraulic Cement Mortars (Using 2-in. or [50 mm] Cube Specimens)

Chemical				
Procedure Number	Owner	Field Use	In Manual	Test Method
C 311	ASTM			Sampling and Testing Fly Ash or Natural Pozzolans for Use in Portland Cement Concrete
C 579	ASTM			Compressive Strength of Chemical-Resistant Mortars, Grouts, Monolithic Surfacing, and Polymer Concretes
C 881	ASTM			Standard Specification for Epoxy-Resin-Base Bonding Systems for Concrete
C 882	ASTM		✓	Bond Strength of Epoxy-Resin Systems Used With Concrete By Slant Shear
D 638	ASTM			Tensile Properties of Plastics
D 695	ASTM			Compressive Properties of Rigid Plastics
D 792	ASTM			Density and Specific Gravity (Relative Density) of Plastics by Displacement
D 1751	ASTM			Preformed Expansion Joint Filler for Concrete Paving and Structural Construction (Nonextruding and Resilient Bituminous Types)
D 2240	ASTM			Rubber Property-Durometer Hardness
D 2628/ M 220	ASTM		✓	Preformed Polychloroprene Elastomeric Joint Seals for Concrete Pavements
D 5167	ASTM			Melting of Hot-Applied Joint and Crack Sealant and Filler for Evaluation
D 5329	ASTM			Sealants and Fillers, Hot-Applied, for Joints and Cracks in Asphalt Pavements and Portland Cement Concrete Pavements
D 6690	ASTM			Joint and Crack Sealants, Hot Applied, for Concrete and Asphalt Pavements
D 7091	ASTM		✓	Nondestructive Measurement of Dry Film Thickness of Nonmagnetic Coatings Applied to Ferrous Metals and Nonmagnetic, Nonconductive Coatings Applied to Non-Ferrous Metals

Concrete				
Procedure Number	Owner	Field Use	In Manual	Test Method
TM 2	WAQTC	✓	✓	WAQTC TM 2, Sampling Freshly Mixed Concrete
T 22	AASHTO			Compressive Strength of Cylindrical Concrete Specimens
T 22	WSDOT	✓	✓	FOP for AASHTO T 22, Compressive Strength of Cylindrical Concrete Specimens
T 24	AASHTO			Obtaining and Testing Drilled Cores and Sawed Beams of Concrete
R 39	AASHTO			Standard Practice for Making and Curing Concrete Test Specimens in the Laboratory
R 60	AASHTO			Sampling Freshly Mixed Concrete
R 100	AASHTO			Method of Making and Curing Concrete Test Specimens in the Field
R 100	WAQTC	✓	✓	FOP for AASHTO T 23, Method of Making and Curing Concrete Test Specimens in the Field
T 106	AASHTO			Compressive Strength of Hydraulic Cement Mortars (Using 50-mm or 2-in. Cube Specimens)
T 106	WSDOT	✓	✓	FOP for AASHTO for Compressive Strength of Hydraulic Cement Mortars (Using 2-in. or (50-mm) Cube Specimens)
T 119	AASHTO			Slump of Hydraulic Cement Concrete
T 119	WAQTC	✓	✓	FOP for AASHTO T 119, Slump of Hydraulic Cement Concrete
T 121	AASHTO			Density (Unit Weight), Yield, and Air Content (Gravimetric) of Concrete
T 121	WAQTC	✓	✓	FOP for AASHTO T 121, Density (Unit Weight), Yield, and Air Content (Gravimetric) of Concrete

Concrete				
Procedure Number	Owner	Field Use	In Manual	Test Method
C 140	ASTM			Sampling and Testing Concrete Masonry Units and Related Units
T 141	AASHTO			Sampling Freshly Mixed Concrete
T 152	AASHTO			Air Content of Freshly Mixed Concrete by the Pressure Method
T 152	WAQTC	✓	✓	FOP for AASHTO T 152, Air Content of Freshly Mixed Concrete by the Pressure Method
T 196	AASHTO		✓	Air Content of Freshly Mixed Concrete by the Volumetric Method (Checklist Only)
T 197	AASHTO			Time of Setting of Concrete Mixtures by Penetration Resistance
T 198	AASHTO			Splitting Tensile Strength of Cylindrical Concrete Specimens
M 201	AASHTO			Mixing Rooms, Moist Cabinets, Moist Rooms, and Water Storage Tanks Used in the Testing of Hydraulic Cements and Concretes
T 231	AASHTO			Capping Cylindrical Concrete Specimens
T 231	WSDOT	✓	✓	FOP for AASHTO T 231, Capping Cylindrical Concrete Specimens
T 260	AASHTO			Sampling and Testing for Chloride Ion in Concrete and Concrete Raw Materials
T 277	AASHTO			Electrical Indication of Concrete's Ability to Resist Chloride Ion Penetration
T 309	AASHTO			Temperature of Freshly Mixed Portland Cement Concrete
T 309	WAQTC	✓	✓	FOP for AASHTO T 309, Temperature of Freshly Mixed Portland Cement Concrete
T 359	AASHTO			Pavement Thickness by Magnetic Pulse Induction
C 457	ASTM			Microscopical Determination of Parameters of the Air-Void System in Hardened Concrete
C 495	ASTM			Compressive Strength of Lightweight Insulated Concrete
T 716	WSDOT	✓	✓	Method of Random Sampling for Locations of Testing and Sampling Sites
T 802	WSDOT	✓	✓	Method of Test for Flexural Strength of Concrete (Using Simple Beam With Center-Point Loading)
C 805	ASTM			Rebound Number of Hardened Concrete
C 805	WSDOT	✓	✓	Rebound Hammer Determination of Compressive Strength of Hardened Concrete
T 808	WSDOT	✓	✓	Method for Making Flexural Test Beams
T 813	WSDOT	✓	✓	Field Method of Fabrication of 2 in (50 mm) Cube Specimens for Compressive Strength Testing of Grouts and Mortars
T 818	WSDOT		✓	Air Content of Freshly Mixed Self-Compacting Concrete by the Pressure Method
T 819	WSDOT		✓	Making and Curing Self-Compacting Concrete Test Specimens in the Field
C 939	ASTM			Flow of Grout for Preplaced-Aggregate Concrete (Flow Cone Method)
C 939	WSDOT	✓	✓	FOP for ASTM C 939. Flow of Grout for Preplaced-Aggregate Concrete (Flow Cone Method)
C 1218	ASTM			Water-Soluble Chloride in Mortar and Concrete
C 1231	ASTM			Use of Unbonded Caps in Determination of Compressive Strength of Hardened Cylindrical Concrete Specimens
C 1231	WSDOT	✓	✓	FOP for ASTM C1231, Use of Unbonded Caps in Determination of Compressive Strength of Hardened Cylindrical Concrete Specimens
D 1429	ASTM			Specific Gravity of Water and Brine
C 1604	ASTM			Obtaining and Testing Drilled Cores of Shotcrete
C 1611	WSDOT	✓	✓	FOP for ASTM C 1611/C 1611M Standard Test Method for Slump Flow of Self-Consolidating Concrete
C 1621	WSDOT	✓	✓	FOP for ASTM C 1621/C 1621M Standard Test Method for Passing Ability of Self-Consolidating Concrete by J-Ring

Electrical				
Procedure Number	Owner	Field Use	In Manual	Test Method
IP 78-16	FHWA			Type 170 Signal Controller System Hardware Specification
TEES	Caltrans			Caltrans Transportation Electrical Equipment Specifications
PE-1	NEMA			Standards Publication: Uninterruptible Power Systems (UPS) – Specification and Performance Verification
TS-1	NEMA			Standards Publication: Traffic Control Systems
TS-2	NEMA			Standards Publication: Traffic Controller Assemblies with NTCIP Requirements
T 421	WSDOT		✓	Traffic Controller Inspection Procedure
T 422	WSDOT		✓	Transient Voltage Test (Spike Test) Procedure (optional)
T 423	WSDOT		✓	Conflict Monitor Test Procedure
T 424	WSDOT		✓	Power Interruption Test Procedure
T 425	WSDOT		✓	Environmental Chamber Test Procedure
T 427	WSDOT		✓	Loop Amplifier Test Procedure
T 428	WSDOT		✓	Traffic Controller Compliance Inspection and Test Procedure
SOP 429	WSDOT		✓	Methods for Determining the Acceptance of Traffic Signal Controller Assemblies
T 430	WSDOT		✓	Uninterruptible Power Supply (UPS) System Compliance Inspection and Test Procedure
1188	IEEE			Standards Publication: Recommended Practice for Maintenance, Testing, and Replacement of Valve-Regulated Lead-Acid (VRLA) batteries for Stationary Applications
ATC 5301	AASHTO ITE NEMA			Publication: Advanced Transportation Controller (ATC) Cabinet Standard
62040-3	IEC			Standards Publication: Uninterruptible Power Systems (UPS) – Method for specifying the performance and test requirements

Geotechnical – Soils				
Procedure Number	Owner	Field Use	In Manual	Test Method
R 58	AASHTO			Dry Preparation of Disturbed Soil and Soil Aggregate Samples for Test
R 75	AASHTO			Developing a Family of Curves
R 75	WAQTC	✓	✓	FOP for AASHTO R 75, Developing a Family of Curves
T 88	AASHTO			Particle Size Analysis of Soils
T 89	AASHTO		✓	Determining the Liquid Limit of Soils (Checklist Only)
T 90	AASHTO		✓	Determining the Plastic Limit and Plasticity Index of Soils (Checklist Only)
T 99	AASHTO			Moisture-Density Relations of Soils Using a 2.5 kg (5.5 lb) Rammer and a 305 mm (12 in.) Drop
T 99	WAQTC	✓	✓	FOP for AASHTO T 99, Moisture-Density Relations of Soils Using a 2.5 kg (5.5 lb) Rammer and a 305 mm (12 in.) Drop
T 100	AASHTO			Specific Gravity of Soils
T 180	AASHTO			Moisture-Density Relations of Soils Using a 4.54 kg (10 lb) Rammer and a 457 mm (18 in.) Drop
T 180	WAQTC	✓	✓	FOP for AASHTO T 180, Moisture-Density Relations of Soils Using a 4.54 kg (10 lb) Rammer and a 457 mm (18 in.) Drop
T 208	AASHTO			Unconfined Compressive Strength of Cohesive Soil
T 215	AASHTO			Permeability of Granular Soils (Constant Head)
T 216	AASHTO			One-Dimensional Consolidation Properties of Soils
T 236	AASHTO			Direct Shear Test of Soils Under Consolidated Drained Conditions
T 265	AASHTO			Laboratory Determination of Moisture Content of Soils
T 265	WAQTC	✓	✓	FOP for AASHTO T 265, Laboratory Determination of Moisture Content of Soils
T 296	AASHTO			Unconsolidated, Undrained Compressive Strength of Cohesive Soils in Triaxial Compression
T 297	AASHTO			Consolidated, Undrained Triaxial Compressive Test on Cohesive Soils Shear
T 501	WSDOT		✓	Test Method to Determine Durability of Very Weak Rock
D 2487	ASTM			Standard Practice for Classification of Soils for Engineering Purposes (Unified Soil Classification System)
D 2488	ASTM			Standard Practice for Description and Identification of Soils (Visual-Manual Procedure)
D 4186	ASTM			One-Dimensional Consolidation Properties of Saturated Cohesive Soils Using Controlled-Strain Loading
D 4644	ASTM			Slake Durability of Shales and Similar Weak Rocks
D 4767	ASTM			Standard Test Method for Consolidated Undrained Triaxial Compression Test for Cohesive Soils
D 5084	ASTM			Measurement of Hydraulic Conductivity of Saturated Porous Materials Using a Flexible Wall Permeameter
D 5311	ASTM			Load Controlled Cyclic Triaxial Strength of Soil
D 5731	ASTM			Determination of the Point Load Strength Index of Rock and Application to Rock Strength Classifications
D 6467	ASTM			Torsional Ring Shear Test to Determine Drained Residual Shear Strength of Cohesive Soils
D 6528	ASTM			Consolidated Undrained Direct Simple Shear Testing of Cohesive Soils
D 7012	ASTM		✓	Compressive Strength and Elastic Moduli of Intact Rock Core Specimens under Varying States of Stress and Temperatures

Geotextile and Steel				
Procedure Number	Owner	Field Use	In Manual	Test Method
E 18	ASTM			Rockwell Hardness of Metallic Materials
A 143	ASTM			Standard Practice for Safeguarding Against Embrittlement of Hot-Dip Galvanized Structural Steel Products and Procedure for Detecting Embrittlement
T 244	AASHTO			Mechanical Testing of Steel Products
T 285	AASHTO			Bend Test for Bars for Concrete Reinforcement
A 370	ASTM			Definitions for Mechanical Testing of Steel Products
E 290	ASTM			Standard Test Methods for Bend Testing of Material for Ductility
F 606	ASTM			Determining the Mechanical Properties of Externally and Internally Threaded Fasteners, Washers, Direct Tension Indicators, and Rivets
A 615	ASTM			Standard Specification for Deformed and Plain Carbon-Steel Bars for Concrete Reinforcement
SOP 914	WSDOT	✓	✓	Practice for Sampling of Geosynthetic Material for Testing
T 915	WSDOT		✓	Practice for Conditioning of Geotextiles for Testing
T 923	WSDOT		✓	Thickness Measurement of Geotextiles
T 925	WSDOT		✓	Standard Practice for Determination of Long-Term Strength for Geosynthetic Reinforcement
T 926	WSDOT		✓	Geogrid Brittleness Test
D 1683	ASTM			Failure in Sewen Seams of Woven Fabrics
D 4354	ASTM		✓	Standard Practice for Sampling of Geosynthetics and Rolled Erosion Control Products (RECPs) for Testing
D 4355	ASTM			Deterioration of Geotextiles From Exposure to Light, Moisture and Heat in a Xenon-Arc-Type Apparatus
D 4491	ASTM			Water Permeability of Geotextiles by permittivity
D 4533	ASTM			Trapezoid Tearing Strength of Geotextiles
D 4595	ASTM			Tensile Properties of Geotextiles by the Wide-Width Strip Method
D 4632	ASTM			Grab Breaking Load and Elongation of Geotextiles
D 4751	ASTM			Determining Apparent Opening Size of a Geotextiles
D 6241	ASTM			Static Puncture Strength of Geotextiles and Geotextile-Related Products Using a 50-mm Probe

Paint				
Procedure Number	Owner	Field Use	In Manual	Test Method
D 523	ASTM			Specular Gloss
D 823	ASTM			Producing Films of Uniform Thickness of Paint, Coatings and Related Products on Test Panels
D 1475	ASTM			Density of Liquid Coatings, Inks, and Related Products
D 2244	ASTM			Standard Practice for Calculation of Color Tolerances and Color Differences From Instrumentally Measured Color Coordinates
D 2369	ASTM			Volatile Content of Coatings
D 2621	ASTM			Infrared Identification of Vehicle Solids From Solvent-Reducible Paints
D 2697	ASTM			Volume Nonvolatile Matter in Clear or Pigmented Coatings
D 2698	ASTM			Determination of the Pigment Content of Solvent-Reducible Paints by High-Speed Centrifuging

Pavement Soils				
Procedure Number	Owner	Field Use	In Manual	Test Method
TM 15	WAQTC		✓	Laboratory Theoretical Maximum Dry Density of Granular Soil and Soil/Aggregate
T 242	AASHTO			Frictional Properties of Paved Surfaces Using a Full-Scale Tire
T 272	AASHTO			One-Point Method for Determining Maximum Dry Density and Optimum Moisture
T 272	WAQTC	✓	✓	FOP for AASHTO T 272, One-Point Method for Determining Maximum Dry Density and Optimum Moisture
T 310	AASHTO			In-Place Density and Moisture Content of Soil and Soil-Aggregate by Nuclear Methods (Shallow Depth)
T 310	WAQTC	✓	✓	FOP for AASHTO T 310, In-Place Density and Moisture Content of Soil and Soil-Aggregate by Nuclear Methods (Shallow Depth)
T 610	WSDOT		✓	Method of Test for the Capillary Rise of Soils
SOP 615	WSDOT	✓	✓	Determination of the % Compaction for Embankment & Untreated Surfacing Materials Using the Nuclear Moisture-Density Gauge
SOP 738	WSDOT	✓	✓	Establishing Maximum Field Density for Recycled Concrete Aggregates by Test Point Evaluation
T 807	WSDOT	✓	✓	Method of Operation of California Profilograph and Evaluation of Profiles
D 4694	ASTM			Deflections with a Falling-Weight-Type Impulse Load Device

Standard Practice				
Procedure Number	Owner	Field Use	In Manual	Test Method
QC 1	WSDOT		✓	Standard Practice for Cement Producers/Suppliers That Certify Portland Cement and Blended Hydraulic Cement
QC 2	WSDOT		✓	Standard Practice for Asphalt Suppliers That Certify Performance Graded and Emulsified Asphalts
QC 3	WSDOT		✓	Quality System Laboratory Review
QC 4	WSDOT		✓	Standard Practice for Fly Ash Producers/Importers/Distributors That Certify Fly Ash
QC 5	WSDOT		✓	Standard Practice for Ground Granulated Blast-Furnace Slag Producers/Importers/Distributors That Certify Ground Granulated Blast-Furnace Slag
QC 6	WSDOT		✓	Annual Prestressed Plant Review and Approval Process
QC 7	WSDOT		✓	Annual Precast Plant Review and Approval Process
QC 8	WSDOT		✓	Standard Practice for Development, Submittal and Approval of Hot Mix Asphalt Mix Designs
QC 9	WSDOT		✓	Standard Practice for Approval of Recycled Materials Facilities of WSDOT Recycled Concrete and Returned Concrete
QC 10	WSDOT		✓	Standard Practice for Approval of Recycled Materials Facilities from Stockpiles of Unknown Sources
QC 11	WSDOT		✓	Vacant
QC 12	WSDOT		✓	Standard Practice for Evaluation of Aggregate Sources

Numerical Order				
Procedure Number	Owner	Field Use	In Manual	Test Method
LRFD CONS	AASHTO			Section 18, Bearing Devices
QC 1	WSDOT		✓	Standard Practice for Cement Producers/Suppliers That Certify Portland Cement and Blended Hydraulic Cement
QC 2	WSDOT		✓	Standard Practice for Asphalt Suppliers That Certify Performance Graded and Emulsified Asphalts
QC 3	WSDOT		✓	Quality System Laboratory Review
QC 4	WSDOT		✓	Standard Practice for Fly Ash Producers/Importers/Distributors That Certify Fly Ash
QC 5	WSDOT		✓	Standard Practice for Ground Granulated Blast-Furnace Slag Producers/Importers/Distributors That Certify Ground Granulated Blast-Furnace Slag
QC 6	WSDOT		✓	Annual Prestressed Plant Review and Approval Process
QC 7	WSDOT		✓	Annual Precast Plant Review and Approval Process
QC 8	WSDOT		✓	Standard Practice for Development, Submittal and Approval of Hot Mix Asphalt Mix Designs
QC 9	WSDOT		✓	Standard Practice for Approval of Recycled Materials Facilities of WSDOT Recycled Concrete and Returned Concrete
QC 10	WSDOT		✓	Standard Practice for Approval of Recycled Materials Facilities from Stockpiles of Unknown Sources
QC 11	WSDOT		✓	Vacant
QC 12	WSDOT		✓	Standard Practice for Evaluation of Aggregate Sources
TEES	Caltrans			Caltrans Transportation Electrical Equipment Specifications
PE-1	NEMA			Standards Publication: Uninterruptible Power Systems (UPS) – Specification and Performance Verification
TS-1	NEMA			Standards Publication: Traffic Control Systems
TS-2	NEMA			Standards Publication: Traffic Controller Assemblies with NTCIP Requirements
TM 2	WAQTC	✓	✓	WAQTC TM 2, Sampling Freshly Mixed Concrete
T 11	AASHTO			Materials Finer Than 0.075 mm (No. 200) Sieve in Mineral Aggregates by Washing
TM 13	WAQTC		✓	Volumetric Properties of Asphalt Mixtures
TM 14	WAQTC		✓	Laboratory Prepared Asphalt Mixture Specimens
TM 15	WAQTC		✓	Laboratory Theoretical Maximum Dry Density of Granular Soil and Soil/Aggregate
E 18	ASTM			Rockwell Hardness of Metallic Materials
R 18	AASHTO			Establishing and Implementing a Quality Management System for Construction Materials Testing Laboratories
T 19	AASHTO	✓	✓	Bulk Density (“Unit Weight”) and Voids in Aggregate (Rodding Procedure Only) (Checklist Only)
T 21	AASHTO			Organic Impurities in Fine Aggregates for Concrete
T 22	AASHTO			Compressive Strength of Cylindrical Concrete Specimens
T 22	WSDOT	✓	✓	FOP for AASHTO T 22, Compressive Strength of Cylindrical Concrete Specimens
T 24	AASHTO			Obtaining and Testing Drilled Cores and Sawed Beams of Concrete
T 27	AASHTO			Sieve Analysis of Fine and Coarse Aggregates
T 27_T 11	WAQTC	✓	✓	FOP for AASHTO T 27_T 11, Sieve Analysis of Fine and Coarse Aggregates
R 28	AASHTO			Standard Practice for Accelerated Aging of Asphalt Binder Using a Pressurized Aging Vessel

Numerical Order				
Procedure Number	Owner	Field Use	In Manual	Test Method
R 29	AASHTO			Standard Practice for Grading or Verifying the Performance Grade (PG) of an Asphalt Binder
R 30	AASHTO			Standard Practice for Mixture Conditioning of Hot Mix Asphalt (HMA)
T 30	AASHTO			Mechanical Analysis of Extracted Aggregate
T 30	WAQTC	✓	✓	FOP for AASHTO T 30, Mechanical Analysis of Extracted Aggregate
T 37	AASHTO			Sieve Analysis of Mineral Filler for Hot Mix Asphalt (HMA)
R 39	AASHTO			Standard Practice for Making and curing Concrete Test Specimens in the Laboratory
T 44	AASHTO			Solubility of Bituminous Materials
R 47	AASHTO			Reducing Samples of Asphalt Mixtures to Testing Size
R 47	WAQTC	✓	✓	FOP for AASHTO R 47, Reducing Samples of Asphalt Mixtures to Testing Size
T 48	AASHTO			Flash and Fire Points by Cleveland Open Cup
T 49	AASHTO			Penetration of Bituminous Materials
T 50	AASHTO			Float Test for Bituminous Materials
T 51	AASHTO			Ductility of Asphalt Materials
T 53	AASHTO			Softening Point of Bitumen (Ring-and-Ball Apparatus)
R 58	AASHTO			Dry Preparation of Disturbed Soil and Soil Aggregate Samples for Test
T 59	AASHTO			Emulsified Asphalts
R 60	AASHTO			Sampling Freshly Mixed Concrete
T 65	AASHTO			Mass (Weight) of Coating on Iron and Steel Articles With Zinc or Zinc-Alloy Coatings
R 66	AASHTO			Sampling Asphalt Materials
R 66	WAQTC	✓	✓	FOP for AASHTO R 66, Sampling Asphalt Materials
E 70	ASTM			pH of Aqueous Solutions With the Glass Electrode
R 71	AASHTO			Sampling and Amount of Testing of Hydraulic Cement
T 72	AASHTO			Saybolt Viscosity
R 75	AASHTO			Developing a Family of Curves
R 75	WAQTC	✓	✓	FOP for AASHTO R 75, Developing a Family of Curves
R 76	AASHTO			Reducing Samples of Aggregate to Testing Size
R 76	WAQTC	✓	✓	FOP for AASHTO R 76, Reducing Samples of Aggregate to Testing Size
IP 78-16	FHWA			Type 170 Signal Controller System Hardware Specification
R 79	AASHTO			Vacuum Drying Compacted Asphalt Specimens
R 79	WAQTC	✓	✓	FOP for AASHTO R 79, Vacuum Drying Compacted Asphalt Specimens
T 84	AASHTO			Specific Gravity and Absorption of Fine Aggregates
T 85	AASHTO			Specific Gravity and Absorption of Coarse Aggregates
T 85	WAQTC	✓	✓	FOP for AASHTO T 85, Specific Gravity and Absorption of Coarse Aggregate
T 88	AASHTO			Particle Size Analysis of Soils
T 89	AASHTO		✓	Determining the Liquid Limit of Soils (Checklist Only)
R 90	AASHTO			Sampling Aggregate Products
R 90	WAQTC	✓	✓	FOP for AASHTO R 90, Sampling Aggregate Products
T 90	AASHTO		✓	Determining the Plastic Limit and Plasticity Index of Soils (Checklist Only)
R 96	AASHTO			Installation, Operation, and Maintenance of Ignition Furnaces
T 96	AASHTO			Resistance to Degradation of Small-Size Coarse Aggregate by Abrasion and Impact in the Los Angeles Machine
R 97	AASHTO			Sampling Asphalt Mixtures
R 97	WAQTC	✓	✓	FOP for AASHTO R 97, Sampling Asphalt Mixtures

Numerical Order				
Procedure Number	Owner	Field Use	In Manual	Test Method
T 99	AASHTO			Moisture-Density Relations of Soils Using a 2.5 kg (5.5 lb) Rammer and a 305 mm (12 in.) Drop
T 99	WAQTC	✓	✓	FOP for AASHTO T 99, Moisture-Density Relations of Soils Using a 2.5 kg (5.5 lb) Rammer and a 305 mm (12 in.) Drop
R 100	AASHTO			Method of Making and Curing Concrete Test Specimens in the Field
R 100	WAQTC	✓	✓	FOP for AASHTO T 23, Method of Making and Curing Concrete Test Specimens in the Field
T 100	AASHTO			Specific Gravity of Soils
T 105	AASHTO			Chemical Analysis of Hydraulic Cement
T 106	AASHTO			Compressive Strength of Hydraulic Cement Mortars (Using 50-mm or 2-in Cube Specimens)
T 106	WSDOT	✓	✓	FOP for AASHTO for Compressive Strength of Hydraulic Cement Mortars (Using 2-in. or (50-mm) Cube Specimens)
T 107	AASHTO			Autoclave Expansion of Hydraulic Cement
M 111	AASHTO			Zinc (Hot-Dip Galvanized) Coatings on Iron and Steel Products
T 112	AASHTO		✓	Clay Lumps and Friable Particles in Aggregate
T 113	WSDOT		✓	Method of Test for Determination of Degradation Value
T 119	AASHTO			Slump of Hydraulic Cement Concrete
T 119	WAQTC	✓	✓	FOP for AASHTO T 119, Slump of Hydraulic Cement Concrete
T 121	AASHTO			Density (Unit Weight), Yield, and Air Content (Gravimetric) of Concrete
T 121	WAQTC	✓	✓	FOP for AASHTO T 121, Density (Unit Weight), Yield, and Air Content (Gravimetric) of Concrete
T 123	WSDOT	✓	✓	Method of Test for Bark Mulch
T 125	WSDOT		✓	Determination of Fiber Length Percentages in Wood Strand Mulch
T 126	WSDOT		✓	Determination of Fiber Length Percentages in Hydraulically-Applied Erosion Control Products
T 127	WSDOT		✓	Preparation of Leachate Sample for Testing Toxicity of HECF Effluents
SOP 128	WSDOT	✓	✓	Sampling for Aggregate Source Approval
T 129	AASHTO			Amount of Water Required for Normal Consistency of Hydraulic Cement Paste
T 131	AASHTO			Time of Setting of Hydraulic Cement by Vicat Needle
T 133	AASHTO			Density of Hydraulic Cement
T 137	AASHTO			Air Content of Hydraulic Cement Mortar
C 140	ASTM			Sampling and Testing Concrete Masonry Units and Related Units
T 141	AASHTO			Sampling Freshly Mixed Concrete
A 143	ASTM			Standard Practice for Safeguarding Against Embrittlement of Hot-Dip Galvanized Structural Steel Products and Procedure for Detecting Embrittlement
T 152	AASHTO			Air Content of Freshly Mixed Concrete by the Pressure Method
T 152	WAQTC	✓	✓	FOP for AASHTO T 152, Air Content of Freshly Mixed Concrete by the Pressure Method
T 153	AASHTO			Fineness of Hydraulic Cement by Air Permeability Apparatus
T 162	AASHTO			Mechanical Mixing of Hydraulic Cement Pastes and Mortars of Plastic Consistency
T 166	AASHTO			Bulk Specific Gravity (G_{mb}) of Compacted Asphalt Mixtures Using Saturated Surface-Dry Specimens
T 166	WAQTC	✓	✓	FOP for AASHTO T 166, for Bulk Specific Gravity of Compacted Asphalt Mixtures Using Saturated Surface-Dry Specimens
T 176	AASHTO			Plastic Fines in Graded Aggregates and Soils by the Use of the Sand Equivalent Test

Numerical Order				
Procedure Number	Owner	Field Use	In Manual	Test Method
T 176	WAQTC	✓	✓	FOP for AASHTO T 176, Plastic Fines in Graded Aggregates and Soils by the Use of the Sand Equivalent Test
T 180	AASHTO			Moisture-Density Relations of Soils Using a 4.54 kg (10 lb) Rammer and a 457 mm (18 in.) Drop
T 180	WAQTC	✓	✓	FOP for AASHTO T 180, Moisture-Density Relations of Soils Using a 4.54 kg (10 lb) Rammer and a 457 mm (18 in.) Drop
T 192	AASHTO			Fineness of Hydraulic Cement by the 45- μ m (No. 325) Sieve
T 196	AASHTO		✓	Air Content of Freshly Mixed Concrete by the (Volumetric Method) (Checklist Only)
T 197	AASHTO			Time of Setting of Concrete Mixtures by Penetration Resistance
T 198	AASHTO			Splitting Tensile Strength of Cylindrical Concrete Specimens
M 201	AASHTO			Mixing Rooms, Moist Cabinets, Moist Rooms, and Water Storage Tanks Used in the Testing of Hydraulic Cements and Concretes
T 208	AASHTO			Unconfined Compressive Strength of Cohesive Soil
T 209	AASHTO			Theoretical Maximum Specific Gravity (G_{mm}) and Density of Asphalt Mixtures
T 209	WAQTC	✓	✓	FOP for AASHTO T 209, Theoretical Maximum Specific Gravity (G_{mm}) and Density of Asphalt Mixtures
T 215	AASHTO			Permeability of Granular Soils (Constant Head)
T 216	AASHTO			One-Dimensional Consolidation Properties of Soils
T 228	AASHTO			Specific Gravity of Semi-Solid Asphalt Materials
T 231	AASHTO			Capping Cylindrical Concrete Specimens
T 231	WSDOT	✓	✓	FOP for AASHTO T 231, Capping Cylindrical Concrete Specimens
T 236	AASHTO			Direct Shear test of Soils Under Consolidated Drained Conditions
T 240	AASHTO			Effect of Heat and Air on a Moving Film of Asphalt Binder (Rolling Thin-Film Oven Test)
T 242	AASHTO			Frictional Properties of Paved Surfaces Using a Full-Scale Tire
T 244	AASHTO			Mechanical Testing of Steel Products
M 251	AASHTO			Plain and Laminated Elastomeric Bridge Bearings
T 255	AASHTO			Total Evaporable Moisture Content of Aggregate by Drying
T 255	WAQTC	✓	✓	FOP for AASHTO T 255, Total Evaporable Moisture Content of Aggregate by Drying
T 260	AASHTO			Sampling and Testing for Chloride Ion in Concrete and Concrete Raw Materials
T 265	AASHTO			Laboratory Determination of Moisture Content of Soils
T 265	WAQTC	✓	✓	FOP for AASHTO T 265, Laboratory Determination of Moisture Content of Soils
T 267	AASHTO			Determination of Organic Content in Soils by Loss on Ignition
T 269	AASHTO			Percent Air Void in Compacted Dense and Open Asphalt Mixtures
T 272	AASHTO			One-Point Method for Determining Maximum Dry Density and Optimum Moisture
T 272	WAQTC	✓	✓	FOP for AASHTO T 272, One-Point Method for Determining Maximum Dry Density and Optimum Moisture
T 277	AASHTO			Electrical Indication of Concrete's Ability to Resist Chloride Ion Penetration
T 285	AASHTO			Bend Test for Bars for Concrete Reinforcement
T 288	AASHTO		✓	Determining Minimum Laboratory Soil Resistivity (Checklist Only)
T 289	AASHTO			Determining pH of Soil for Use in Corrosion Testing
E 290	ASTM			Standard Test Methods for Bend Testing of Material for Ductility

Numerical Order				
Procedure Number	Owner	Field Use	In Manual	Test Method
T 296	AASHTO			Unconsolidated, Undrained Compressive Strength of Cohesive Soils in Triaxial Compression
T 297	AASHTO			Consolidated, Undrained Triaxial Compressive Test on Cohesive Soils Shear
T 301	AASHTO			Elastic Recovery Test of Asphalt Materials by Means of a Ductilometer
T 303	AASHTO			Accelerated Detection of Potentially Deleterious Expansion of Mortar Bars Due to Alkali-Silica Reaction
T 304	AASHTO			Uncompacted Void Content of Fine Aggregate
T 304	WAQTC	✓	✓	FOP for AASHTO T 304, Uncompacted Void Content of Fine Aggregate
T 308	AASHTO			Determining the Asphalt Binder Content of Asphalt Mixtures by the Ignition Method
T 308	WAQTC	✓	✓	FOP for AASHTO T 308, Determining the Asphalt Binder Content of Asphalt Mixtures by the Ignition Method
T 309	AASHTO			Temperature of Freshly Mixed Hydraulic Cement Concrete
T 309	WAQTC	✓	✓	FOP for AASHTO T309, Temperature of Freshly Mixed Portland Cement Concrete
T 310	AASHTO			In-Place Density and Moisture Content of Soil and Soil-Aggregate by Nuclear Methods (Shallow Depth)
T 310	WAQTC	✓	✓	FOP for AASHTO T 310, In-Place Density and Moisture Content of Soil and Soil-Aggregate by Nuclear Methods (Shallow Depth)
C 311	ASTM			Sampling and Testing Fly Ash or Natural Pozzolans for Use in Portland Cement Concrete
T 312	AASHTO			Preparing and Determining the Density of Asphalt Mixture Specimens by Means of the Superpave Gyratory Compactor
T 312	WAQTC	✓	✓	FOP for AASHTO T 312, Preparing and Determining the Density of Asphalt Mixture Specimens by Means of the Superpave Gyratory Compactor
T 313	AASHTO			Determining the Flexural Creep Stiffness of Asphalt Binder Using the Bending Beam Rheometer (BBR)
T 313	WSDOT		✓	Method of Test for Cement-Latex Compatibility
T 314	WSDOT		✓	Method of Test for Photovolt Reflectance
T 315	AASHTO			Determining the Rheological Properties of Asphalt Binder Using a Dynamic Shear Rheometer (DSR)
T 316	AASHTO			Viscosity Determination of Asphalt Binder Using Rotational Viscometer
SOP 318	WSDOT		✓	Standard Operating Procedure for Melting of Flexible Bituminous Pavement Marker Adhesive for Evaluation
T 324	AASHTO		✓	Hamburg Wheel-Track Testing of Compacted Asphalt Mixtures
T 329	AASHTO			Moisture Content of Asphalt Mixtures by Oven Method
T 329	WAQTC	✓	✓	FOP for AASHTO T 329, Moisture Content of Asphalt Mixture by Oven Method
T 331	AASHTO			Bulk Specific Gravity (G_{mb}) and Density of Compacted Asphalt Mixtures Using Automatic Vacuum Sealing Method
T 331	WAQTC	✓	✓	FOP for AASHTO T 331, Bulk Specific Gravity (G_{mb}) and Density of Compacted Asphalt Mixtures Using Automatic Vacuum Sealing Method
T 335	AASHTO			Determining the Percentage of Fracture in Coarse Aggregate
T 335	WAQTC	✓	✓	FOP for AASHTO T 335, Determining the Percentage of Fracture in Coarse Aggregate
T 350	AASHTO			Multiple Stress Creep Recovery (MSCR) Test of Asphalt Binder Using a Dynamic Shear Rheometer (DSR)
T 355	AASHTO			In-Place Density of Asphalt Mixtures by Nuclear Methods

Numerical Order				
Procedure Number	Owner	Field Use	In Manual	Test Method
T 355	WAQTC	✓	✓	FOP for AASHTO T 355, In-Place Density of Asphalt Mixtures by Nuclear Methods
T 359	AASHTO			Pavement Thickness by Magnetic Pulse Induction
A 370	ASTM			Definitions for Mechanical Testing of Steel Products
T 413	WSDOT	✓	✓	Method of Test for Evaluating Waterproofing Effectiveness of Membrane and Membrane-Pavement Systems
T 417	WSDOT		✓	Method of Test for Determining Minimum Resistivity and pH of Soil and Water
T 421	WSDOT		✓	Traffic Controller Inspection Procedure
T 422	WSDOT		✓	Transient Voltage Test (Spike Test) Procedure (optional)
T 423	WSDOT		✓	Conflict Monitor Test Procedure
T 424	WSDOT		✓	Power Interruption Test Procedure
T 425	WSDOT		✓	Environmental Chamber Test Procedure
T 426	WSDOT		✓	Pull-Off Test for Hot Melt Traffic Button Adhesive
T 427	WSDOT		✓	Loop Amplifier Test Procedure
T 428	WSDOT		✓	Traffic Controller Compliance Inspection and Test Procedure
SOP 429	WSDOT		✓	Methods for Determining the Acceptance of Traffic Signal Controller Assemblies
T 430	WSDOT		✓	Uninterruptible Power Supply (UPS) System Compliance Inspection and Test Procedure
T 432	WSDOT		✓	Flexibility Test for Hot-Melt Adhesives
C 457	ASTM			Microscopical Determination of Parameters of the Air-Void System in Hardened Concrete
C 495	ASTM			Compressive Strength of Lightweight Insulated Concrete
T 501	WSDOT		✓	Test Method to Determine Durability of Very Weak Rock
D 523	ASTM			Specular Gloss
C 579	ASTM			Compressive Strength of Chemical-Resistant Mortars, Grouts, Monolithic Surfacing, and Polymer Concretes
F 606	ASTM			Determining the Mechanical Properties of Externally and Internally Threaded Fasteners, Washers, Direct Tension Indicators, and Rivets
T 610	WSDOT		✓	Method of Test for the Capillary Rise of Soils
A 615	ASTM			Standard Specification for Deformed and Plain Carbon-Steel Bars for Concrete Reinforcement
SOP 615	WSDOT	✓	✓	Determination of the % Compaction for Embankment and Untreated Surfacing Materials Using the Nuclear Moisture-Density Gauge
D 638	ASTM			Tensile Properties of Plastics
D 695	ASTM			Compressive Properties of Rigid Plastics
T 716	WSDOT	✓	✓	Method of Random Sampling for Locations of Testing and Sampling Sites
T 720	WSDOT		✓	Method of Test for Thickness Measurement of Hot Mix Asphalt (HMA) Cores
SOP 729	WSDOT	✓	✓	Standard Operating Procedure for Determination of the Moving Average of Theoretical Maximum Density (TMD) for HMA
SOP 730	WSDOT	✓	✓	Standard Operating Procedure for Correlation of Nuclear Gauge Densities With Hot Mix Asphalt (HMA) Cores
SOP 731	WSDOT	✓	✓	Standard Operating Procedure for Determining Volumetric Properties of Hot Mix Asphalt
SOP 732	WSDOT	✓	✓	Standard Operating Procedure for Volumetric Design for Hot-Mix Asphalt (HMA)

Numerical Order				
Procedure Number	Owner	Field Use	In Manual	Test Method
SOP 733	WSDOT	✓	✓	Standard Operating Procedure for Determination of Pavement Density Differentials Using the Nuclear Density Gauge
SOP 734	WSDOT	✓	✓	Standard Operating Procedure for Sampling Hot Mix Asphalt After Compaction (Obtaining Cores)
SOP 735	WSDOT	✓	✓	Standard Operating Procedure for Longitudinal Joint Density
SOP 736	WSDOT		✓	In-Place Density of Bituminous Mixes Using Cores
SOP 737	WSDOT		✓	Procedure for the Forensic Testing of HMA Field Cores
SOP 738	WSDOT	✓	✓	Establishing Maximum Field Density for Recycled Concrete Aggregates by Test Point Evaluation
D 792	ASTM			Density and Specific Gravity (Relative Density) of Plastics by Displacement
T 802	WSDOT	✓	✓	Method of Test for Flexural Strength of Concrete (Using Simple Beam With Center-Point Loading)
C 805	ASTM			Rebound Number of Hardened Concrete
C 805	WSDOT	✓	✓	Rebound Hammer Determination of Compressive Strength of Hardened Concrete
T 807	WSDOT	✓	✓	Method of Operation of California Profilograph and Evaluation of Profiles
T 808	WSDOT	✓	✓	Method for Making Flexural Test Beams
T 813	WSDOT	✓	✓	Field Method of Fabrication of 2 in (50 mm) Cube Specimens for Compressive Strength Testing of Grouts and Mortars
T 814	WSDOT		✓	Method of Test for Water Retention Efficiency of Liquid Membrane-Forming Compounds and Impermeable Sheet Materials for Curing Concrete
T 818	WSDOT		✓	Air Content of Freshly Mixed Self-Compacting Concrete by the Pressure Method
T 819	WSDOT		✓	Making and Curing Self-Compacting Concrete Test Specimens in the Field
D 823	ASTM			Producing Films of Uniform Thickness of Paint, Coatings and Related Products on Test Panels
C 881	ASTM			Standard Specification for Epoxy-Resin-Base Bonding Systems for Concrete
C 882	ASTM		✓	Bond Strength of Epoxy-Resin Systems Used With Concrete By Slant Shear (Checklist Only)
SOP 914	WSDOT	✓	✓	Practice for Sampling of Geosynthetic Material for Testing
T 915	WSDOT		✓	Practice for Conditioning of Geotextiles for Testing
T 923	WSDOT		✓	Thickness Measurement of Geotextiles
T 925	WSDOT		✓	Standard Practice for Determination of Long-Term Strength for Geosynthetic Reinforcement
T 926	WSDOT		✓	Geogrid Brittleness Test
C 939	ASTM			Flow of Grout for Preplaced-Aggregate Concrete (Flow Cone Method)
C 939	WSDOT	✓	✓	FOP for ASTM for Flow of Grout for Preplaced-Aggregate Concrete (Flow Cone Method)
1188	IEEE			Standards Publication: Recommended Practice for Maintenance, Testing, and Replacement of Valve-Regulated Lead-Acid (VRLA) batteries for Stationary Applications
C 1218	ASTM			Water-Soluble Chloride in Mortar and Concrete
C 1231	ASTM			Use of Unbonded Caps in Determination of Compressive Strength of Hardened Cylindrical Concrete Specimens

Numerical Order				
Procedure Number	Owner	Field Use	In Manual	Test Method
C 1231	WSDOT	✓	✓	FOP for ASTM C1231, Use of Unbonded Caps in Determination of Compressive Strength of Hardened Cylindrical Concrete Specimens
C 1437	ASTM			Standard Test Method for Flow of Hydraulic Cement Mortar
D 1475	ASTM			Density of Liquid Coatings, Inks, and Related Products
C 1604	ASTM			Obtaining and Testing Drilled Cores of Shotcrete
C 1611	WSDOT	✓	✓	FOP for ASTM C 1611/C 1611M Standard Test Method for Slump Flow of Self-Consolidating Concrete
C 1621	WSDOT	✓	✓	FOP for ASTM C 1621/C 1621M Standard Test Method for Passing Ability of Self-Consolidating Concrete by J-Ring
D 1683	ASTM			Failure in Sewn Seams of Woven Fabrics
D 1751	ASTM			Preformed Expansion Joint Filler for Concrete Paving and Structural Construction (Nonextruding and Resilient Bituminous Types)
D 2240	ASTM			Standard Test Method for Rubber Property – Durometer Hardness
D 2244	ASTM			Standard Practice for Calculation of Color Tolerances and Color Differences From Instrumentally Measured Color Coordinates
D 2369	ASTM			Volatile Content of Coatings
D 2487	ASTM			Standard Practice for Classification of Soils for Engineering Purposes (Unified Soil Classification System)
D 2488	ASTM			Standard Practice for Description and Identification of Soils (Visual-Manual Procedure)
D 2621	ASTM			Infrared Identification of Vehicle Solids From Solvent-Reducible Paints
D 2628/ M 220	ASTM	✓	✓	Preformed Polychloroprene Elastomeric Joint Seals for Concrete Pavements
D 2697	ASTM			Volume Nonvolatile Matter in Clear or Pigmented Coatings
D 2698	ASTM			Determination of the Pigment Content of Solvent-Reducible Paints by High-Speed Centrifuging
D 3111	ASTM			Flexibility Determination of Hot-Melt Adhesives by Mandrel Bend Test Method
D 3723	ASTM			Pigment Content of Water Emulsion Paints by Temperature Ashing
D 4186	ASTM			One-Dimensional Consolidation Properties of Saturated Cohesive Soils Using Controlled-Strain Loading
D 4354	ASTM		✓	Standard Practice for Sampling of Geosynthetics and Rolled Erosion Control Products (RECPs) for Testing
D 4355	ASTM			Deterioration of Geotextiles From Exposure to Light, Moisture and Heat in a Xenon-Arc-Type Apparatus
D 4491	ASTM			Water Permeability of Geotextiles by Permittivity
D 4533	ASTM			Trapezoid Tearing Strength of Geotextiles
D 4595	ASTM			Tensile Properties of Geotextiles by the Wide-Width Strip Method
D 4632	ASTM			Grab Breaking Load and Elongation of Geotextiles
D 4644	ASTM			Slake Durability of Shales and Similar Weak Rocks
D 4694	ASTM			Deflections with Falling-Weight-Type Impulse Load Device
D 4751	ASTM			Determining Apparent Opening Size of a Geotextile
D 4767	ASTM			Standard Test Method for Consolidated Undrained Triaxial Compression Test for Cohesive Soils
D 5084	ASTM			Measurement of Hydraulic Conductivity of Saturated Porous Materials Using a Flexible Wall Permeameter
D 5167	ASTM			Melting of Hot-Applied Joint and Crack Sealant and Filler for Evaluation
ATC 5301	AASHTO ITE NEMA			Publication: Advanced Transportation Controller (ATC) Cabinet Standard

Numerical Order				
Procedure Number	Owner	Field Use	In Manual	Test Method
D 5311	ASTM			Load Controlled Cyclic Triaxial Strength of Soil
D 5329	ASTM			Sealants and Fillers, Hot-Applied, for Joints and Cracks in Asphalt Pavements and Portland Cement Concrete Pavements
D 5731	ASTM			Determination of the Point Load Strength Index of Rock and Application to Rock Strength Classifications
D 6241	ASTM			Static Puncture Strength of Geotextiles and Geotextile-Related Products Using a 50-mm Probe
D 6467	ASTM			Torsional Ring Shear Test to Determine Drained Residual Shear Strength of Cohesive Soils
D 6528	ASTM			Consolidated Undrained Direct Simple Shear Testing of Cohesive Soils
D 6690	ASTM			Joint and Crack Sealants, Hot Applied, for Concrete and Asphalt Pavements
D 6931	ASTM		✓	Indirect Tensile (IDT) Strength of Asphalt Mixtures
D 7012	ASTM		✓	Compressive Strength and Elastic Moduli of Intact Rock Core Specimens under Varying States of Stress and Temperatures
D 7091	ASTM		✓	Nondestructive Measurement of Dry Film Thickness of Nonmagnetic Coatings Applied to Ferrous Metals and Nonmagnetic, Nonconductive Coatings Applied to Non-Ferrous Metals (Checklist Only)
62040-3	IEC			Standards Publication: Uninterruptible Power Systems (UPS) – Method for specifying the performance and test requirements



WSDOT Standard Practice QC 3

Quality System Laboratory Review

1. Scope

This standard specifies requirements and procedures for the review of WSDOT Region Materials Laboratories and for Private Laboratories by the Quality Systems Laboratory Review Team. The elements of the On-site and/or Remote laboratory review may include the following:

- Review of the testing facility.
- Review of the equipment calibration/standardization/check/maintenance records.
- Review of the testing technician's training/certification/qualification records.
- Review of the equipment used to perform test procedures.
- Review of the technician performing the test procedures.
- Review of the most current and accessible test procedures to be performed.
- Review of associated manuals, test reports and calculations.
- Review of the Quality Management System (QMS).
- Review of AASHTO re:source accreditation.

2. Referenced Documents

2.1 AASHTO Standards

- R 18 Establishing and Implementing a Quality Management System for Construction Materials Testing Laboratories
- R 25 Standard Practice for Technician Training and Certification Programs
- R 61 Establishing Requirements for Equipment Calibrations, Standardizations, and Checks

2.2 WSDOT Standards

Materials Manual M 46-01

[Construction Manual](#) M 41-01

[Standard Specifications for Road, Bridge, and Municipal Construction](#) M 41-10

WSDOT Request for Proposal Technical Requirements for the Project under review

3. Terminology

- 3.1 **AASHTO** – American Association of State Highway and Transportation Officials
- 3.2 **ASTM** – American Society for Testing and Materials
- 3.3 **Calibration** – a process that, under specified conditions, establishes metrological traceability by determining: (1) the relation between the quantity values provided by measurement standards and the corresponding indications from a measuring instrument or system, and (2) the resulting measurement uncertainty (Note 1).
- Note 1:** This definition for calibration and the following definitions for check, standardization, traceability, uncertainty, and verification of calibration are based on the definitions in R 61.
- 3.4 **Check** – A specific type of inspection and/or measurement performed on equipment and materials to indicate compliance or otherwise with stated criteria.
- 3.5 **Standardization** – A process that determines (1) the correction to be applied to the result of a measuring instrument, measuring system, material measure, or reference material when its values are compared to the values realized by standards; or (2) the adjustment to be applied to a piece of equipment when its performance is compared with that of an accepted standard or process.
- 3.6 **Maintenance** – A regularly scheduled preventive measure taken to preserve the effective working condition of test equipment
- 3.7 **Measurement Standard** – The embodiment of the definition of a given quantity, with a stated value and measurement uncertainty, used as a reference.² This term is often called “reference standard.”
- 3.8 **Metrological Traceability** – The property of a result of a measurement whereby it can be related to stated references, usually national or international standards, through a documented, unbroken chain of calibrations, each contributing to the measurement uncertainty.
- 3.9 **Quality Management System (QMS)** – The organizational structure, staff responsibilities, policies, standard operating procedures, processes, and records that assist the laboratory in achieving its quality objectives.
- 3.10 **Uncertainty** – A parameter associated with the result of a measurement that defines the range of the values that could be attributed to the measured quantity.
- 3.11 **WSDOT** – Washington State Department of Transportation
- 3.12 **WAQTC** – Western Alliance for Quality Transportation Construction
- 3.13 **ACI** – American Concrete Institute

4. Significance and Use

- 4.1 This standard specifies procedures for reviewing laboratories for the purpose of determining the capability of the facility and its personnel to perform the necessary acceptance testing for WSDOT.

5. Laboratory Requirements

5.1 Facility and Equipment

- 5.1.1 Laboratory facilities shall adequately house and allow proper operation of all required equipment in accordance with the applicable test procedures.
- 5.1.2 The temperature and humidity of the laboratory shall meet the requirements of all test procedures performed in the laboratory.
- 5.1.3 The testing areas shall be clean and free of clutter.
- 5.1.4 The laboratory shall use testing equipment that meets the requirements of each test procedure.
- 5.1.5 Testing equipment for private laboratories and the State Materials Laboratory shall be calibrated/standardized/checked/maintained in accordance with the test procedure, appropriate sections of AASHTO R 18 and AASHTO R 61. WSDOT region and field laboratories testing equipment shall be calibrated/standardized/checked/maintained in accordance with the test procedure and Section 9-5 of the [Construction Manual M 41-01](#).
- 5.1.6 Documentation of equipment calibration/standardization/check/maintenance shall be maintained and available on-site during laboratory review.
- 5.1.7 Safety equipment will be available and maintained in proper working order.

5.2 Technician Training and Evaluation

- 5.2.1 The laboratory shall only use personnel certified or method qualified in accordance with the appropriate sections of AASHTO R 18 and Section 9-5 of the [Construction Manual M 41-01](#).
- 5.2.2 The laboratory shall maintain records of training for each technician.
- 5.2.3 Laboratory technicians performing tests for Aggregate, Asphalt, or Soils compaction on WSDOT projects shall be certified in WAQTC requisite modules.
- 5.2.4 Laboratory technicians performing tests not associated with any module certification shall be method qualified as described in Section 9-5.4 of the [Construction Manual M 41-01](#).

5.2.5 A method qualification shall consist of a written and performance examination. The performance examination shall be evaluated using a checklist relating to the test procedure. The checklist and written exam shall be filed in the technician's training record.

Note: Private laboratories may use test procedure checklists from the WSDOT *Materials Manual M 46-01*, or may develop their own checklists similar to those found in the *Materials Manual*.

5.2.6 A method qualification can be for a maximum of five years or for private laboratories at a reduced frequency stated in the *Laboratory Quality Management System Manual (QMS)*.

5.2.7 An Independent Assurance (IA) evaluation will be performed a minimum of once per calendar year on all active testers.

5.3 Manuals and Records

5.3.1 Private laboratories shall have an up-to-date Laboratory Quality Management System Manual (QMS) on-site and meeting the requirements of AASHTO R 18.

5.3.2 All private laboratories QMS shall be available for use and understood by laboratory staff.

5.3.3 The laboratory shall maintain copies of standards as identified in the WSDOT *Materials Manual M 46-01* for the testing performed and shall ensure that the procedures are the most current and readily accessible to technicians performing the testing. Laboratory personnel shall also have access to the most current copy of the WSDOT *Construction Manual M 41-01*.

Note: If an earlier version of the *Materials Manual* or *Construction Manual* is required by contract, the laboratory shall maintain an unaltered version of the required manual.

5.3.5 The laboratory must ensure Safety Data Sheets (SDSs) are readily accessible to all staff for any hazardous substances or products.

5.3.6 Test records are required to contain sufficient information to permit verification of any test report (original observations, calculations, derived data, and identification of personnel involved in the sampling and testing).

5.3.7 Amendments to reports must be made in the manner stated in the QMS and meet the requirements of AASHTO R 18.

5.3.8 The laboratory shall define the process used to ensure testers are performing the correct testing procedure according to the clients' contractual requirements (i.e., AASHTO, ASTM, WAQTC, or WSDOT test procedure as required by the contract).

- 5.3.9 Test reports are required to contain the following information:
- Identification of the report and date issued.
 - Description, identification, and condition of test sample.
 - Identification of the standard test method used and notation of all known deviations from, additions to, or exclusions from the test method.
 - Test results and other pertinent data required by the standard test method.
 - Name and address of the testing laboratory.
 - Name and address of the client or identification of the project.
 - Date of receipt of the test sample.
 - Date of test performance.
 - Name of tester performing the test.
 - Name of person accepting technical responsibility for test report.

6. Sampling

6.1 Test samples required for observation of test procedures shall be obtained by:

FOP for AASHTO R 90 – Sampling Aggregate Products

FOP for AASHTO R 97 – Sampling Asphalt Mixtures

FOP for WAQTC TM 2 – Sampling Freshly Mixed Concrete

7. Sample Preparation Requirements

7.1 Prior to the performance portion of the laboratory review, for the testing being performed, samples are required to be prepared as shown in [Table 1](#).

Table 1 Sample Preparation Requirements

Test Procedure	Test	Required Preparation
Aggregate Tests		
FOP for AASHTO T 27/11	Sieve Analysis of Fine and Coarse Aggregates	Have appropriate amount of the original sample reduced and dried to a constant mass. *OPTIONAL: Have additional sample washed, dried, and ready for sieving. Retain all weights in order to do calculations.
FOP for AASHTO R 76	Reducing Samples of Aggregates to Testing Size	Have a minimum of 30 lbs dry material.
AASHTO T 84	Specific Gravity and Absorption of Fine Aggregates	Have approximately 1000 g of fine aggregate.
AASHTO T 85	Specific Gravity and Absorption of Coarse Aggregates	Have coarse aggregate meeting the minimum mass of test sample.
FOP for AASHTO T 176	Plastic Fines in Graded Aggregates and Soils by the Use of the Sand Equivalent Test	Have appropriate amount of #4 minus material prepared for the moisture conditioning process (do not moisten). OPTIONAL: Have 2 additional prepared tins ready for introduction into the SE tube.
FOP for AASHTO T 255	Total Evaporable Moisture Content of Aggregate by Drying	Have a representative sample meeting the minimum sample mass.
FOP for AASHTO T 304	Uncompacted Void Content of Fine Aggregate	Have an appropriate size standard graded sample. *OPTIONAL: Have additional sample weighed out and combined to the quantities identified in Table 1.
FOP for AASHTO T 335	Determining the Percentage of Fracture in Coarse Aggregate	Have a sample dried, sieved and reduced to appropriate test size for combined fracture determination.

Table 1 Sample Preparation Requirements

Test Procedure	Test	Required Preparation
Concrete Tests		
WSDOT FOP for AASHTO T 22	Compressive Strength of Cylindrical Concrete Specimens	Have 2 cylindrical concrete specimens.
WSDOT FOP for AASHTO T 106	Compressive Strength of Hydraulic Cement Mortar	Have 3 hydraulic cement mortar cube specimens.
AASHTO T 231	Capping Cylindrical Concrete Specimens	Have capping sulfur mortar heated to appropriate temperature and ready for capping (can use cylinders for T 22).
ASTM C1231	Use of Unbonded Caps in Determination of Compressive Strength of Hardened Cylindrical Concrete Specimens	Demonstrate if applicable (can use cylinders for T 22).
Soils Tests		
AASHTO T 89	Determining the Liquid Limit of Soils	Have sample prepared in accordance to step 11.1. of AASHTO procedure.
AASHTO T 90	Determining the Plastic Limit and Plasticity Index of Soils	Have sample prepared in accordance to step 5.2. of AASHTO procedure.
FOP for AASHTO T 99/T 180	Moisture-Density Relations of Soils	Prepare five representative samples of #4 or ¾" material at approximately 2 percent moisture already added to each sample starting at approximately 4 percent below optimum moisture of the material. Store in sealed containers.
AASHTO T 100	Specific Gravity of Soils	Have sample prepared in accordance to step 9. of AASHTO procedure.
AASHTO T 265	Laboratory Determination of Moisture Content of Soils	Have a representative sample meeting the minimum sample mass.
WSDOT Test Method T 417	Method of Test for Determining Minimum Resistivity and pH of Soil and Water	Have 100 g sample of natural #8 minus material for the pH test. Prepare the soil/ water slurry a minimum of 1 hr prior to test review. Have a sample of # 8 minus material that is four times the volume of the soil box for the Resistivity test. Add 10% by weight of water to the sample and allow it to stand a minimum of 12 hrs in a waterproof container.
WAQTC TM 15	Method of Test for Compaction Control of Granular Materials	Have samples prepared in accordance to steps 7 and 8. of TM 15.

Table 1 Sample Preparation Requirements

Test Procedure	Test	Required Preparation
Asphalt Mixture Tests		
FOP for AASHTO T 30	Mechanical Analysis of Extracted Aggregate	Use sample from T 308. *OPTIONAL: Have additional sample washed, dried, and ready for sieving. Retain all weights in order to do calculations.
FOP for AASHTO R 47	Reducing Samples of Asphalt Mixtures to Testing Size	Have adequate amount of asphalt mixture to perform the following required testing; T 308, T 312, T 329, T 209 (approximately 30 lbs of mix is usually adequate). Have sample warm enough to separate.
FOP for AASHTO T 166	Bulk Specific Gravity (G_{mb}) of Compacted Asphalt Mixtures Using Saturated Surface-Dry Specimens	Use sample from T 312. *OPTIONAL: Have a room temperature compacted specimen or core sample ready.
FOP for AASHTO T 209	Theoretical Maximum Specific Gravity (G_{mm}) and Density of Asphalt Mixtures	Use reduced sample from R 47. *OPTIONAL: Have additional sample with particles separated and cooled to room temperature.
FOP for AASHTO T 308	Determining the Asphalt Binder Content of Asphalt Mixtures by the Ignition Method	Use reduced sample from R 47.
FOP for AASHTO T 312	Preparing and Determining the Density of Asphalt Mixture Specimens by Means of the Superpave Gyrotory Compactor	Use reduced sample from R 47. *OPTIONAL: Have additional sample heating at compaction temperature.
FOP for AASHTO T 329	Moisture Content of Asphalt Mixtures by Oven Method	Use reduced sample from R 47.
FOP for AASHTO T 331	Bulk Specific Gravity (G_{mb}) and Density of Compacted Asphalt Mixtures Using Automatic Vacuum Sealing Method	Use sample from T 312. *OPTIONAL: Have a room temperature compacted specimen or core sample ready.

Table 1 Sample Preparation Requirements

Test Procedure	Test	Required Preparation
WSDOT Test Method T 720	Method of Test for Thickness Measurement for Asphalt Mixture Cores	Asphalt Mixture core obtained from WSDOT SOP 734.
WAQTC TM 15	Laboratory Prepared Asphalt Mixture Specimens	Representative aggregate from stockpiles used in JMF, dried to a constant mass. Aggregate samples prepared and heated to mixing temperature as recommended by binder supplier. Binder used in JMF mix design heated to mixing temperature as recommended by binder supplier (typically one quart container).
WSDOT SOP 730	Correlation of Nuclear Gauge Densities with Asphalt Mixture Cores	Verbal demonstration and completed worksheet/report reflecting calculated gauge correlation factor.
* OPTIONAL preparation may require verbal steps.		

8. Performance of Test Procedure

8.1 All technicians must be current in their WAQTC/ACI certifications or method qualifications.

8.2 The laboratory review team will evaluate the technician's testing proficiency using an approved WSDOT checklist.

Note: If certification or qualification is current and an IA audit has been performed in the last 12 months, this requirement may be considered satisfied and no further action is needed.

8.3 All equipment, used during the evaluation of the technician's proficiency, must be operational and have a current calibration sticker on the equipment.

8.4 When the test is complete, the reviewer will go over the checklist with the tester and point out any deficiencies that occurred during the performance of the test procedure.

9. Termination of Review

9.1 A laboratory review team member may choose to terminate the review of a procedure for the following reasons:

9.1.1 Equipment is non-operational or the wrong equipment is being used.

9.1.2 Tester is not qualified in the test procedure being reviewed.

9.1.3 Tester makes multiple major errors in the performance of the test.

9.2 The review of the laboratory may be terminated by the WSDOT Quality Systems Manager for the following reasons:

9.2.1 Facility is not adequate for the test procedures being reviewed.

9.2.2 Two or more testers fail during the proficiency portion of the review.

9.2.3 Documentation of qualification of testers or calibration of equipment is not available for review when team arrives.

10. Failure of Review

10.1 Rescheduling a review will require the following wait periods:

- First Failure – Minimum of one week wait to reschedule.
- Second Failure – Minimum of one month wait to reschedule.
- Third Failure – Minimum of one month wait and submittal of corrective action documentation. The documents submitted must state the concerns of the review team and the corrective action taken to solve the problem.

11. Laboratory Review Team Report

- 11.1 The Laboratory Review Team will review the facility, equipment, records, and testers compliance with the established requirements.
- 11.2 During the review, members of the team may:
 - 11.2.1 Have observations or recommendations for improvements to the performance of the test procedure or operation of test equipment. These will be noted on the final letter of qualification but does not require a response unless repeated in consecutive reviews.
 - 11.2.2 Have findings that can be addressed and resolved at the time of the on-site review.
 - 11.2.3 Have findings that require a written corrective action response.
 - 11.2.4 Have repeat findings that require a detailed written corrective action response that includes a root cause analysis.

12. Approval of Laboratory

- 12.1 A preliminary email will be prepared and sent to the laboratory within 30 days of the completion of the review.
 - 12.1.1 The preliminary email will only address "Findings" labeled "Corrective Action Required".
 - 12.1.2 The required corrective action must include a detailed explanation stating how the laboratory has resolved the finding and what measures have been taken to prevent this finding from reoccurring in the future. Substantiating evidence may be required along with detailed explanations in some circumstances.
 - 12.1.3 Once the preliminary email has been received, the laboratory will have 30 days to respond to all "Findings" labeled "Corrective Action Required."
 - 12.2 Once all corrective actions are received and accepted or if the laboratory had no findings requiring a response, a final letter of qualification will be issued. The final letter will address the following:
 - 12.2.1 All the elements of the on-site or remote review
 - 12.2.2 Results of review including all findings, observations and recommendations.
 - 12.2.3 Approved test procedures.
 - 12.2.4 Qualification Approval dates.
- Note:** For private laboratories, approval is only good for WSDOT projects identified on final letter of qualification.

- 12.3 If the laboratory review contained corrective action required findings, the laboratory may receive a conditional approval until the deficiencies are corrected or the review team may recommend that the laboratory be disapproved for all testing until the deficiencies are corrected to the satisfaction of the WSDOT Quality System Manager.
- 12.4 A Laboratory that presents a current AASHTO re:source Accreditation certificate specific to the project testing requirements; may be allowed to perform acceptance testing for up to two years with a satisfactory initial review by the Laboratory Review Team concurred with by the Asst. State Materials Engineer.

WSDOT Standard Practice QC 4

Standard Practice for Fly Ash Producers/Importers/Distributors That Certify Fly Ash

1. Scope

This standard specifies requirements for all producers/importers/distributors of fly ash.

This standard may involve hazardous materials, operations and equipment. It does not address all of the safety problems associated with their use. It is the responsibility of those using this standard to consult and establish appropriate safety and health practices and determine the applicability of regulatory limitations prior to use.

2. Referenced Documents

2.1 AASHTO Standards

M 295 Standard Specification for Coal Fly Ash and Raw or Calcined Natural Pozzolan for Use in Concrete

R 18 Establishing and Implementing a Quality Management System for Construction Materials Testing Laboratories

2.2 ASTM Standards

C618 Standard Specification for Coal Fly Ash and Raw or Calcined Natural Pozzolan for Use in Concrete

C311 Standard Test Methods for Sampling and Testing Fly Ash or Natural Pozzolans for Use in Portland-Cement Concrete

2.3 WSDOT Standards and Documents

Current WSDOT [Standard Specifications](#) M 41-10

Current WSDOT Qualified Products List

3. Terminology

3.1 AASHTO – American Association of State Highway and Transportation Officials

3.2 ASTM – American Society of Testing and Materials

3.3 CCRL – Cement and Concrete Reference Laboratory

3.4 WSDOT – Washington State Department of Transportation: the agency responsible for the final acceptance of fly ash.

3.5 QPL – Qualified Products List

3.6 Production Facility – A facility that has the capacity for producing fly ash that meets the requirements of the [Standard Specifications](#) Section 9-23.9.

- 3.7 Import/Distribution Facility – A facility that receives finished fly ash products for distribution that meets the requirements of the *Standard Specifications* Section 9-23.9.
- 3.8 Supplier – A supplier stores and then delivers fly ash produced by another entity to a concrete plant or another supplier.
- 3.9 Supplier Certification – Certification of the fly ash provided by the supplier or importer using representative test results obtained in accordance with a WSDOT approved QMP and approved testing lab.
- 3.10 Quality Management Plan – The producer/importer/distributor plan to ensure that the fly ash meets the specification requirements through a systematic program of sampling, testing, and inspection.
- 3.11 Specification Compliance Testing – Complete testing in accordance with the specification requirements for the material identified.
- 3.12 Quality Control Testing – Testing performed per the producer/importer/distributor quality management plan to evaluate the production process.
- 3.13 CAP – Cement Acceptance Program
- 3.14 Manufacturer's Certification (Mill Test Report) – A document provided by the producer/importer/distributor showing the physical and chemical test results with specification limits for each property tested on the fly ash.
- 3.15 Fly Ash – Fly ash meeting the requirements of *Standard Specifications* Section 9-23.9.
- 3.16 No Production Report – A document provided to WSDOT when fly ash was not produced or shipped during a given month.

4. Significance and Use

- 4.1 This standard specifies procedures for accepting fly ash. This is accomplished by the cement acceptance program that evaluates quality control and specification compliance tests performed by the production/import/distribution facility according to their quality management plan. Products determined to meet the requirements of this standard are eligible for listing on the WSDOT Qualified Products List (QPL).

5. Laboratory and Tester Requirements

The producers/importers/distributors testing laboratory used to conduct specification compliance testing for the quality management program shall be an AASHTO accredited laboratory and shall maintain AASHTO accreditation while participating in the WSDOT CAP program. Only laboratories that are participants in the CCRL on-site inspection and proficiency sample program and are accredited from the AASHTO Accreditation Program (AAP) are recognized as approved laboratories for this program.

6. Qualification of Production/Import/Distribution Facility

- 6.1 Producers/importers/distributors shall submit a written request to WSDOT for acceptance into CAP and provide the following:
- A copy of the producer/importer/distributor quality management plan meeting the requirements of Section 7 of QC 4.
 - A copy of the producer/importer/distributor testing laboratory's AASHTO accreditation. One representative 10 pound sample for each type of fly ash along with the corresponding mill test report. Samples shall be taken in accordance with ASTM C311.
 - A copy of the Safety Data Sheet (SDS) as applicable for each sample submitted.
 - Mill test reports from the previous three (3) months from the producer/importer/distributor facility.
- 6.2 WSDOT will evaluate the submittal and may test the samples provided in accordance with Section 9 of QC 4. WSDOT will notify prospective producers/importers/distributors in writing after completion of the evaluation. All determinations of approval or rejection by WSDOT shall be final.
- 6.3 The producer/importer/distributor shall allow WSDOT to visit and observe the quality control activities and provide samples to WSDOT upon request.

7. Production/Import/Distribution Facility Quality Management Plan

- 7.1 The quality management plan, as a minimum, shall identify the following:
- Facility type.
 - Facility address.
 - Name, email address, and telephone number of the contact person responsible for the quality control of the facility.
 - List each quality control test method to be performed on each class of fly ash.
 - Name and address of the AAP testing laboratory performing specification compliance testing.
 - Declaration stating that if a test result indicates a lot of fly ash is not in compliance with the WSDOT specifications, the facility shall immediately notify WSDOT of the lot in question. A representative sample for the production period in question shall be sent to WSDOT for testing.
 - Description of the method and frequency of sampling, quality control testing, and specification compliance testing.
 - Class of fly ash the production/import/distribution facility intends to provide to WSDOT.
 - A statement of compliance with Section 5.
- 7.2 A new quality management plan shall be required whenever changes occur that cause the existing quality management plan to become inaccurate or invalid.

8. Documentation Requirements

- 8.1 Each producer/importer/distributor shall certify conformance to [Standard Specifications](#) for physical and chemical requirements of AASHTO M 295/ASTM C618 by means of a mill test report.
- 8.2 A mill test report shall be provided monthly by the producer/importer/distributor to WSDOT on a continuous basis for AASHTO M 295/ASTM C618 fly ash production.
- Fly Ash mill test reports shall be in English and include the following information:
- Name of producer/importer/distributor
 - Specific type of fly ash in accordance with [Standard Specifications Section 9-23.9](#)
 - Unique identification number traceable to the date of production
 - Production date
- 8.3 A mill test report shall be provided by the fly ash producer/importer/distributor to WSDOT whenever a new shipment of AASHTO M 295/ASTM C618 imported fly ash is received for distribution.
- Fly ash test reports shall be in English and include the following information:
- Name of producer/importer/distributor
 - Specific type of fly ash in accordance with [Standard Specifications](#) Section 9-23.9
 - Unique identification number traceable to each shipment
 - Certification date
- 8.4 Separate sequences of mill test reports shall be provided for each individual production facility and a unique lot number traceable to a production run on fly ash shall identify each report.
- 8.5 The mill test report shall show the test results and the applicable specification of AASHTO M 295/ASTM C618 for each component or property tested and shall show the test requirements specified by WSDOT.
- 8.6 When a production facility does not produce fly ash in a given month, or no shipments are received by an importer/distributor, the producer/importer/distributor shall notify WSDOT with a no production report for each month of no production or shipment.
- 8.7 Mill test reports and no production reports shall be emailed to the CAP program at the following email address: caprogram@wsdot.wa.gov.
- 8.8 The producer/importer/distributor shall notify WSDOT at the email address noted above of any temporary stops in production (greater than one month) or permanent stops in production.
- 8.9 All documentation shall be submitted to WSDOT within 28 days of the last day of the month of production or shipment.

9. Quarterly Split Sample

- 9.1 Producers/importers/distributors shall, on a quarterly basis, provide a split sample of each type of fly ash being produced.
- 9.2 For the purpose of this standard, quarters are defined as: January through March, April through June, July through September, and October through December.
- 9.3 Split samples shall be taken from production or shipment in accordance with the producer/importer/distributor's quality management plan.
- 9.4 The production sample shall be split into two portions (approximately 10 pounds each) for each type of fly ash being produced. One portion shall be retained by the producer/importer/distributor and one portion shall be sent to WSDOT CAP.
- 9.5 The producer/importer/distributor testing laboratory shall conduct chemical and physical testing on their portion.
- 9.6 The sample submitted to WSDOT shall be labeled with the type and lot number traceable to the production run or lot of fly ash. WSDOT may elect to test the sample.
- 9.7 Samples shall be sent to:
WSDOT State Materials Laboratory
ATTN: Cement Acceptance Program
1655 S Second Ave SW
Tumwater, WA 98512-6951
- 9.8 The quarterly split sample mill test report shall be emailed to the CAP program at the following email address: caprogram@wsdot.wa.gov
- 9.9 The producer/importer/distributor shall email CAP at the email address noted in Section 9.8 if no fly ash was produced/imported/distributed during that quarter and no sample will be submitted.
- 9.10 The quarterly split samples, and accompanying mill test report, shall be submitted to WSDOT within 28 days of the date of sampling.

10. Comparison of Quarterly Split Sample Test Results

- 10.1 Results of the split sample testing shall conform to the applicable AASHTO or ASTM specification requirements.
- 10.2 If any discrepancy is identified between the producer/importer/distributors and WSDOT's test results the producer/importer/distributor shall prepare a response to WSDOT, within 30 days of being notified of discrepancy.
- 10.3 The response shall identify the cause of the discrepancy and describe any corrective action taken.

11. Revocation of Qualification

11.1 A producer/importer/distributor may have its qualification status revoked and be removed from the QPL if found in nonconformance with the [Standard Specifications](#) or this standard practice. Causes for removal from the QPL may include, but are not limited to, the following:

- Failure to comply with requirements of QC 4.
- Failing test results on produced/imported/distributed samples.
- Failure to notify WSDOT of changes in product formulation.
- Failure to send in a retained sample for additional testing for a production period with failing test results.

Prior to removing a producer/importer/distributor from the QPL, WSDOT will take appropriate measures to confirm the validity of the information and will confer with the producer/importer/distributor.

12. Requalification

12.1 Once a product has been removed from the QPL, the producer/importer/distributor may request reinstatement by providing the following written information to WSDOT:

- The root cause and corrective action taken to prevent future reoccurrences of the problem that caused the removal from the QPL.
- Updated quality management plan showing compliance with QC 4.
- Other information and test data as determined by WSDOT.

Provided there is a satisfactory resolution of the initial problem, at WSDOT's discretion, the product may either be reinstated into the QPL or the producer/importer/distributor may be required to reapply to the QPL. All costs of the QPL process shall be borne by the producer/importer/distributor.



WSDOT Standard Practice QC 5

Standard Practice for Ground Granulated Blast-Furnace Slag Producers/Suppliers That Certify Ground Granulated Blast-Furnace Slag

1. Scope

This standard specifies requirements for all producers/suppliers of ground granulated blast-furnace slag.

This standard may involve hazardous materials, operations and equipment. It does not address all of the safety problems associated with their use. It is the responsibility of those using this standard to consult and establish appropriate safety and health practices and determine the applicability of regulatory limitations prior to use.

2. Referenced Documents

2.1 AASHTO Standards

M 302 Standard Specifications for Ground Granulated Blast-Furnace Slag for Use in Concrete and Mortars

R 18 Establishing and Implementing a Quality Management System for Construction Materials Testing Laboratories

2.2 ASTM Standards

C989 Standard Specifications for Ground Granulated Blast-Furnace Slag for Use in Concrete and Mortars

2.3 WSDOT Standards and Documents

Current WSDOT [Standard Specifications](#) M 41-10

Current WSDOT [Qualified Products List](#)

3. Terminology

3.1 **AASHTO** – American Association of State Highway and Transportation Officials

3.2 **ASTM** – American Society of Testing and Materials

3.3 **CCRL** – Cement and Concrete Reference Laboratory

3.4 **WSDOT** – Washington State Department of Transportation: the agency responsible for the final acceptance of ground granulated blast-furnace slag.

- 3.5 **QPL** – Qualified Products List
- 3.6 **Producer** – A production facility that has the capacity for producing and/or grinding ground granulated blast-furnace slag that meets the requirements of the [Standard Specifications](#) Section 9-23.10.
- 3.7 **Supplier** – A supplier stores and then delivers ground granulated blast-furnace slag produced by another entity to a concrete plant or another supplier.
- 3.8 **Supplier Certification** – Certification of ground granulated blast-furnace slag provided by the supplier or importer using representative test results obtained in accordance with an agency approved QC plan and approved testing lab.
- 3.9 **Quality Management Plan** – The producer/supplier plan to ensure that the ground granulated blast-furnace slag meets the specification requirements through a systematic program of sampling, testing, and inspection.
- 3.10 **Specification Compliance Testing** – Complete testing in accordance with the specification requirements for the material identified.
- 3.11 **Quality Control Testing** – Testing performed per the producer/supplier quality management plan to evaluate the production process.
- 3.12 **CAP** – Cement Acceptance Program
- 3.13 **Manufacturer’s Certification (Mill Test Report)** – A document provided by the producer/supplier showing the physical and chemical test results with specification limits for each property tested on the GGBFS.
- 3.14 **Ground granulated blast-furnace slag** – Ground granulated blast-furnace slag (GGBFS) meeting the requirements of [Standard Specifications](#) Section 9-23.10.
- 3.15 **No Production Report** – A document provided to WSDOT when ground granulated blast-furnace slag was not produced or shipped during a given month.

4. Significance and Use

This standard specifies procedures for accepting ground granulated blast-furnace slag. This is accomplished by the cement acceptance program that evaluates quality control and specification compliance tests performed by the producers/suppliers according to their quality management plan. Products determined to meet the requirements of this standard are eligible for listing on the WSDOT Qualified Products List (QPL).

5. Laboratory and Tester Requirements

The producers/suppliers testing laboratory used to conduct specification compliance testing for the quality management program shall be an AASHTO accredited laboratory and shall maintain AASHTO accreditation while participating in the WSDOT CAP program. Only laboratories that are participants in the CCRL on-site inspection and proficiency sample program and are accredited from the AASHTO Accreditation Program (AAP) are recognized as approved laboratories for the program.

6. Qualification of Producers/Suppliers

- 6.1 Producers/suppliers shall submit a written request to WSDOT for acceptance into CAP and provide the following:
- A copy of the producer/supplier quality management plan meeting the requirements of Section 7 of QC 5.
 - A copy of the producer/supplier testing laboratory's AASHTO accreditation. One representative 10 pound sample for each type of GGBFS along with the corresponding mill test report. Samples shall be taken in accordance with the QMP.
 - A copy of the Safety Data Sheet (SDS) as applicable for each sample submitted.
 - Mill test reports from the previous three (3) months from the producer/supplier facility.
- 6.2 WSDOT will evaluate the submittal and may test the samples provided in accordance with Section 9 of QC 5. WSDOT will notify prospective producers/suppliers in writing after completion of the evaluation. All determinations of approval or rejection by WSDOT shall be final.
- 6.3 The producer/supplier shall allow WSDOT to visit and observe the quality control activities and provide samples to WSDOT upon request.

7. Production/Supplier Facility Quality Management Plan

- 7.1 The quality management plan, as a minimum, shall identify the following:
- Facility type.
 - Facility location.
 - Name, email address, and telephone number of the contact person responsible for the quality control of the facility.
 - List each quality control test method to be performed on each grade of ground granulated blast-furnace slag.
 - Name and address of the AAP testing laboratory performing specification compliance testing.
 - Declaration stating that if a test result indicates a lot of GGBFS is not in compliance with the WSDOT specifications, the facility shall immediately notify WSDOT of the lot in question. A representative sample for the production period in question shall be sent to WSDOT for testing.
 - Description of the method and frequency for sampling, quality control testing, and specification compliance testing.
 - Grade of GGBFS the producer/supplier intends to provide to WSDOT.
 - A statement of compliance with Section 5.
- 7.2 A new quality management plan shall be required whenever changes occur that cause the existing quality management plan to become inaccurate or invalid.

8. Documentation Requirements

- 8.1 Each producer/supplier shall certify conformance to *Standard Specifications* for physical and chemical requirements of AASHTO M 302/ASTM C989 by means of a mill test report.
- 8.2 A mill test report shall be provided monthly by the producer/supplier to WSDOT on a continuous basis for AASHTO M 302/ASTM C989 GGBFS production.

Ground granulated blast-furnace slag test reports shall be in English and include the following information:

- Name of producer/supplier
- Specific grade of GGBFS in accordance with *Standard Specifications* Section 9-23.10
- Unique identification number traceable to the date of production
- Production date

- 8.3 A mill test report shall be provided by the GGBFS producer/supplier to WSDOT whenever a new shipment of AASHTO M 302/ASTM C989 imported GGBFS is received for distribution.

GGBFS reports shall be in English and include the following information:

- Name of producer/supplier
- Specific grade of GGBFS in accordance with *Standard Specifications* Section 9-23.10
- Unique identification number traceable to each shipment
- Certification date

- 8.4 Separate sequences of mill test reports shall be provided for each individual production facility and a unique lot number traceable to a production run on GGBFS shall identify each report.

- 8.5 The mill test report shall show the test results and the applicable specification of AASHTO M 302/ASTM C989 for each component or property tested and shall show the test requirements specified by WSDOT.

- 8.6 When a production facility does not produce GGBFS in a given month, or no shipments are received by a supplier, the producer/supplier shall notify WSDOT with a no production report for each month of no production or shipment.

- 8.7 Mill test reports and no production reports shall be emailed to the CAP program at the following email address: caprogram@wsdot.wa.gov.

- 8.8 The producer/supplier shall notify WSDOT at the email address noted above of any temporary stops in production (greater than one month) or permanent stops in production.

- 8.9 All documentation shall be submitted to WSDOT within 28 days of the last day of the month of production or shipment.

9. Quarterly Split Sample

- 9.1 Producers/suppliers shall, on a quarterly basis, provide a split sample of each grade of ground granulated blast-furnace slag being produced.
- 9.2 For the purpose of this standard, quarters are defined as January through March, April through June, July through September, and October through December.
- 9.3 Split samples shall be taken from production or shipment in accordance with the producer/supplier's quality management plan.
- 9.4 The production sample shall be split into two portions (approximately 10 pounds each) for each grade of GGBFS being produced. One portion shall be retained by the producer/supplier and one portion shall be sent to WSDOT CAP.
- 9.5 The producer/supplier testing laboratory shall conduct chemical and physical testing on their portion.
- 9.6 The sample submitted to WSDOT shall be labeled with the grade and lot number traceable to the production run or lot of GGBFS. WSDOT may elect to test the sample.
- 9.7 Samples shall be sent to:

WSDOT State Materials Laboratory
ATTN: Cement Acceptance Program
1655 S Second Ave SW
Tumwater, WA 98512-6951
- 9.8 The quarterly split sample mill test report shall be emailed to the CAP program at the following email address: caprogram@wsdot.wa.gov
- 9.9 The producer/supplier shall email CAP at the email address noted in Section 9.8 if no GGBFS was produced/supplied during that quarter and no sample will be submitted.
- 9.10 The quarterly split samples, and accompanying mill test report, shall be submitted to WSDOT within 28 days of the date of sampling.

10. Comparison of Split Sample Test Results

- 10.1 Results of the split sample testing shall conform to the applicable AASHTO or ASTM specification requirements.
- 10.2 If any discrepancy is identified between the producer/supplier and WSDOT's test results the producer/supplier shall prepare a response to WSDOT, within 30 days of being notified of discrepancy.
- 10.3 The response shall identify the cause of the discrepancy and describe any corrective action taken.

11. Revocation of Qualification

11.1 A producer/supplier may have its qualification status revoked and be removed from the QPL if found in nonconformance with the *Standard Specifications* or this standard practice. Causes for removal from the QPL may include, but are not limited to, the following:

- Failure to comply with requirements of QC 5.
- Failing test results on produced/supplied samples.
- Failure to notify WSDOT of changes in product formulation.
- Failure to send in a retained sample for additional testing for a production period with failing test results.

Prior to removing a producer/supplier from the QPL, WSDOT will take appropriate measures to confirm the validity of the information and will confer with the producer/supplier.

12. Requalification

12.1 Once a product has been removed from the QPL, the producer/supplier may request reinstatement by providing the following written information to WSDOT:

- The root cause and corrective action taken to prevent future reoccurrences of the problem that caused the removal from the QPL.
- Updated quality management plan showing compliance with QC 5.
- Other information and test data as determined by WSDOT.

Provided there is a satisfactory resolution of the initial problem, at WSDOT's discretion, the product may either be reinstated into the QPL or the producer/supplier may be required to reapply to the QPL. All costs of the QPL process shall be borne by the producer/supplier.

SAMPLING FRESHLY MIXED CONCRETE WAQTC TM 2

Scope

This practice covers procedures for obtaining representative samples of fresh concrete delivered to the project site. The practice includes sampling from stationary, paving and truck mixers, and from agitating and non-agitating equipment used to transport central mixed concrete.

This practice also covers the removal of large aggregate particles by wet sieving.

Sampling concrete may involve hazardous materials, operations, and equipment. This standard does not purport to address all of the safety problems associated with its use. It is the responsibility of the user of this standard to establish appropriate safety and health practices.

Warning—Fresh Hydraulic cementitious mixtures are caustic and may cause chemical burns to skin and tissue upon prolonged exposure.

Apparatus

- Receptacle: wheelbarrow, bucket or other suitable container that does not alter the properties of the material being sampled
- Sample cover (plastic, canvas, or burlap)
- Shovel
- Cleaning equipment, including scrub brush, rubber gloves, water
- Apparatus for wet sieving, including: a sieve(s), meeting the requirements of FOP for AASHTO T 27/T 11, minimum of 2 ft² (0.19 m²) of sieving area, conveniently arranged and supported so that the sieve can be shaken rapidly by hand.

Procedure

1. Use every precaution in order to obtain samples representative of the true nature and condition of the concrete being placed being careful not to obtain samples from the very first or very last portions of the batch. The size of the sample will be 1.5 times the volume of concrete required for the specified testing, but not less than 0.03 m³ (1 ft³).
2. Dampen the surface of the receptacle just before sampling, empty any excess water.

Note 1: Sampling should normally be performed as the concrete is delivered from the mixer to the conveying vehicle used to transport the concrete to the forms; however, specifications may require other points of sampling, such as at the discharge of a concrete pump.

3. Use one of the following methods to obtain the sample:
 - **Sampling from stationary mixers**

Obtain the sample after a minimum of $1/2 \text{ m}^3$ ($1/2 \text{ yd}^3$) of concrete has been discharged. Perform sampling by passing a receptacle completely through the discharge stream, or by completely diverting the discharge into a receptacle. Take care not to restrict the flow of concrete from the mixer, container, or transportation unit so as to cause segregation. These requirements apply to both tilting and non-tilting mixers.
 - **Sampling from paving mixers**

Obtain the sample after the contents of the paving mixer have been discharged. Obtain increments from at least five different locations in the pile and combine into one test sample. Avoid contamination with subgrade material or prolonged contact with absorptive subgrade. To preclude contamination or absorption by the subgrade, the concrete may be sampled by placing a shallow container on the subgrade and discharging the concrete across the container.
 - **Sampling from revolving drum truck mixers or agitators**

Obtain the sample after a minimum of $1/2 \text{ m}^3$ ($1/2 \text{ yd}^3$) of concrete has been discharged. Obtain sample after all of the water has been added to the mixer. Do not obtain sample from the very first or last portions of the batch discharge. Perform sampling by repeatedly passing a receptacle through the entire discharge stream or by completely diverting the discharge into a receptacle. Regulate the rate of discharge of the batch by the rate of revolution of the drum and not by the size of the gate opening.
 - **Sampling from open-top truck mixers, agitators, non-agitating equipment, or other types of open-top containers**

Obtain the sample by whichever of the procedures described above is most applicable under the given conditions.
 - **Sampling from pump or conveyor placement systems**

Obtain sample after a minimum of $1/2 \text{ m}^3$ ($1/2 \text{ yd}^3$) of concrete has been discharged. Obtain sample after all of the pump slurry has been eliminated. Perform sampling by repeatedly passing a receptacle through the entire discharge system or by completely diverting the discharge into a receptacle. Do not lower the pump arm from the placement position to ground level for ease of sampling, as it may modify the air content of the concrete being sampled. Do not obtain samples from the very first or last portions of the batch discharge.
4. Transport sample to the testing location.
5. Remix with a shovel the minimum amount necessary to ensure uniformity. Protect the sample from direct sunlight, wind, rain, and sources of contamination.

6. Complete test for temperature and start tests for slump and air content within 5 minutes of obtaining the sample. Start molding specimens for strength tests within 15 minutes of obtaining the sample. Complete the test methods as expeditiously as possible.

Wet Sieving

When required due to oversize aggregate, the concrete sample shall be wet sieved, after transporting but prior to remixing, for slump testing, air content testing or molding test specimens, by the following:

1. Place the sieve designated by the test procedure over the dampened receptacle.
2. Pass the concrete over the designated sieve. Do not overload the sieve (one particle thick).
3. Shake or vibrate the sieve until no more material passes the sieve. A horizontal back and forth motion is preferred.
4. Discard oversize material including all adherent mortar.
5. Repeat until sample of sufficient size is obtained. Mortar adhering to the wet-sieving equipment shall be included with the sample.
6. Using a shovel, remix the sample the minimum amount necessary to ensure uniformity.

Note 2: Wet sieving is not allowed for samples being used for density determinations according to the FOP for AASHTO T 121.

Report

- On forms approved by the agency
- Sample ID
- Date
- Time
- Location
- Quantity represented

CONCRETE

WAQTC

WAQTC TM 2 (21)

PERFORMANCE EXAM CHECKLIST

**SAMPLING FRESHLY MIXED CONCRETE
WAQTC TM 2**

Participant Name _____ **Exam Date** _____

Record the symbols “P” for passing or “F” for failing on each step of the checklist.

Procedure Element	Trial 1	Trial 2
1. Receptacle dampened and excess water removed?	_____	_____
2. Obtain a representative sample from drum mixer:		
a. Concrete sampled after 1/2 m ³ (1/2 yd ³) discharged?	_____	_____
b. Receptacle passed through entire discharge stream or discharge stream completely diverted into sampling container?	_____	_____
3. Obtain a representative sample from a paving mixer:		
a. Concrete sampled after all the concrete has been discharged?	_____	_____
b. Material obtained from at least 5 different locations in the pile?	_____	_____
c. Avoid contaminating the sample with sub-grade materials.	_____	_____
4. Obtain a representative sample from a pump:		
a. Concrete sampled after 1/2 m ³ (1/2 yd ³) has been discharged?	_____	_____
b. All the pump slurry is out of the lines?	_____	_____
c. Receptacle passed through entire discharge stream or discharge stream completely diverted into sampling container?	_____	_____
d. Do not lower the pump arm from the placement position.	_____	_____
5. Sample transported to place of testing?	_____	_____
6. Sample combined, or remixed, or both?	_____	_____
7. Sample protected?	_____	_____
8. Minimum size of sample used for strength tests 0.03 m ³ (1ft ³)?	_____	_____
9. Completed temperature test within 5 minutes of obtaining sample?	_____	_____
10. Start tests for slump and air within 5 minutes of obtaining sample?	_____	_____
11. Start molding cylinders within 15 minutes of obtaining sample?	_____	_____
12. Protect sample against rapid evaporation and contamination?	_____	_____

OVER

CONCRETE

WAQTC

WAQTC TM 2 (13)

Procedure Element

Trial 1 Trial 2

13. Wet Sieving:

- a. Required sieve size determined for test method to be performed? _____
- b. Concrete placed on sieve and doesn't overload the sieve. _____
- c. Sieve shaken until no more material passes the sieve. _____
- d. Sieving continued until required testing size obtained. _____
- e. Oversized aggregate discarded. _____
- f. Sample remixed. _____

Comments: First attempt: Pass _____ Fail _____ Second attempt: Pass _____ Fail _____

Examiner Signature _____ WAQTC #: _____

This checklist is derived, in part, from copyrighted material printed in ACI CP-1, published by the American Concrete Institute.

PERFORMANCE EXAM CHECKLIST (ORAL)

**SAMPLING FRESHLY MIXED CONCRETE
WAQTC TM 2**

Participant Name _____ **Exam Date** _____

Record the symbols “P” for passing or “F” for failing on each step of the checklist.

Procedure Element	Trial 1	Trial 2
1. What is the minimum sample size? a. 0.03 m ³ or 1 ft ³	_____	_____
2. Describe the surface of the receptacle before the sample is introduced into it? a. It must be dampened.	_____	_____
3. Describe how to obtain a representative sample from a drum mixer. a. Sample the concrete after 1/2 m ³ (1/2 yd ³) has been discharged. b. Pass receptacle through entire discharge stream or completely divert discharge stream into sampling container.	_____	_____
4. Describe how to obtain a representative sample from a paving mixer. a. Sample the concrete after all the concrete has been discharged. b. Obtain the increments from at least 5 different locations in the pile. c. Avoid contaminating the sample with sub-grade materials.	_____	_____
5. Describe how to obtain a representative sample from a pump: a. Sample the concrete after 1/2 m ³ (1/2 yd ³) has been discharged. b. Make sure all the pump slurry is out of the lines. c. Pass receptacle through entire discharge stream or completely divert discharge stream into sampling container. d. Do not lower the pump arm from the placement position.	_____	_____
6. After obtaining the sample what must you do? a. Transport to place of testing.	_____	_____
7. What must be done with the sample once you have transported them to the place of testing? a. Combine and remix the sample. b. Protect sample against rapid evaporation and contamination.	_____	_____

OVER

Procedure Element

Trial 1 Trial 2

- 8. What are the two time parameters associated with sampling?
 - a. Complete temperature test and start tests for slump and air within 5 minutes of sample being obtained? _____
 - b. Start molding cylinders within 15 minutes of sample being obtained? _____
- 9. What test methods may require wet sieving?
 - a. Slump, air content, and strength specimens? _____
- 10. The sieve size used for wet sieving is based on?
 - a. The test method to be performed. _____
- 11. How long must you continue wet sieving?
 - a. Until a sample of sufficient size for the test being performed is obtained. _____
- 12. What is done with the oversized aggregate?
 - a. Discard it. _____
- 13. What must be done to the sieved sample before testing?
 - a. Remix. _____

Comments: First attempt: Pass _____ Fail _____ Second attempt: Pass _____ Fail _____

Examiner Signature _____ WAQTC #: _____

This checklist is derived, in part, from copyrighted material printed in ACI CP-1, published by the American Concrete Institute.

WSDOT Errata to WAQTC TM 13

Volumetric Properties of Asphalt Mixtures

WAQTC TM 13 has been adopted by WSDOT for certification requirements.

When determining volumetric properties of asphalt mixtures on WSDOT projects refer to WSDOT SOP 731 & 732.

VOLUMETRIC PROPERTIES OF ASPHALT MIXTURES WAQTC TM 13

Scope

This procedure covers the determination of volumetric properties of plant produced asphalt mixtures, i.e., air voids (V_a), voids in mineral aggregate (VMA), voids filled with asphalt binder (VFA), effective asphalt binder content (P_{be}) and Dust to Binder Ratio ($P_{\#200}/P_{be}$). The in-production volumetric properties are then compared to agency specifications.

Definition of Terms

- G_{mm} = theoretical maximum specific gravity (Gravity_{mix max})
- G_{mb} = measured bulk specific gravity (Gravity_{mix bulk})
- G_{sb} = oven-dry bulk specific gravity of aggregate (Gravity_{stone bulk})
- G_{sa} = apparent specific gravity of aggregate (Gravity_{stone apparent})
- G_{sc} = effective specific gravity of aggregate (Gravity_{stone effective})
- G_b = specific gravity of the binder (Gravity_{binder})
- V_a = air Voids (Voids_{air})
- VMA = Voids in Mineral Aggregate
- VFA = Voids Filled with Asphalt (binder)
- V_{ba} = absorbed binder volume (Voids_{binder absorbed})
- V_{be} = effective binder volume (Voids_{binder effective})
- P_b = percent binder content (Percent_{binder})
- P_{ba} = percent absorbed binder (Percent_{binder absorbed})
- P_{be} = percent effective binder content (Percent_{binder effective})
- P_s = percent of aggregate (Percent_{stone})
- DP = Dust proportion to effective binder ratio
($P_{\#200}/P_{be}$)

Background

Whether a mix design is developed through a Marshall, Hveem, or Superpave mix design process there are basic volumetric requirements of all. Volumetric properties are the properties of a defined material contained in a known volume. Asphalt mixture volumetric properties can include bulk specific gravity, theoretical maximum specific gravity, air voids, and voids in mineral aggregate.

Many agencies specify values of the volumetric properties to ensure optimum performance of the pavement. The asphalt mixture must be designed to meet these criteria. In production the asphalt mixture is evaluated to determine if the mix still meets the specifications and is consistent with the original mix design (JMF). The production asphalt mixture may vary from the mix design and may need to be modified to meet the specified volumetric criteria.

To compare the in-production volumetric properties to agency specifications and the JMF a sample of loose asphalt mixture mix is obtained in accordance with FOP for AASHTO R 97. The sample is then compacted in a gyratory compactor to simulate the in-place asphalt mixture pavement after it has been placed, compacted, and the volumetric properties of the compacted sample are determined.

Asphalt mixture phase diagram

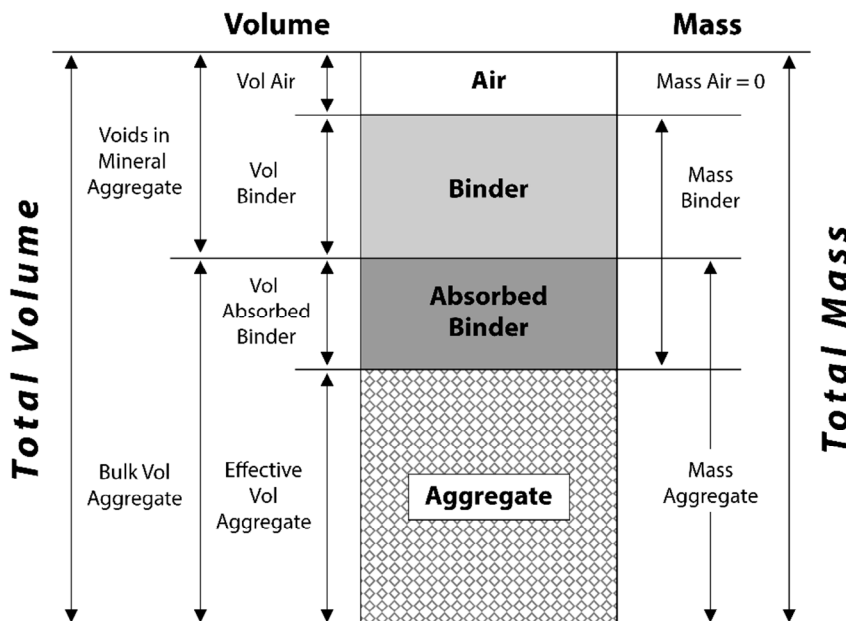

Each of the properties in the asphalt mixture phase diagram can be measured or calculated. For example: The mass of the aggregate is measured; the voids in mineral aggregate (VMA) is calculated; total asphalt binder can be measured but the amount available to act as a binder in the mix must be calculated because it is the quantity left after the aggregate has absorbed some of the asphalt binder.

The volumetric proportions of the asphalt binder and aggregate components of an asphalt mixture and their relationship to the other components are considered. The mass of the components and their specific gravities are used to determine the volumes of each of the components in the mix. The volumetric properties of a compacted asphalt mixture: air voids (V_a), voids in mineral aggregate (VMA), voids filled with asphalt binder (VFA), and effective asphalt binder content (P_{be}) provide some indication of the mixture’s probable performance.

Volumetric Properties

Volumetric Relationship of Asphalt Mixture Constituents

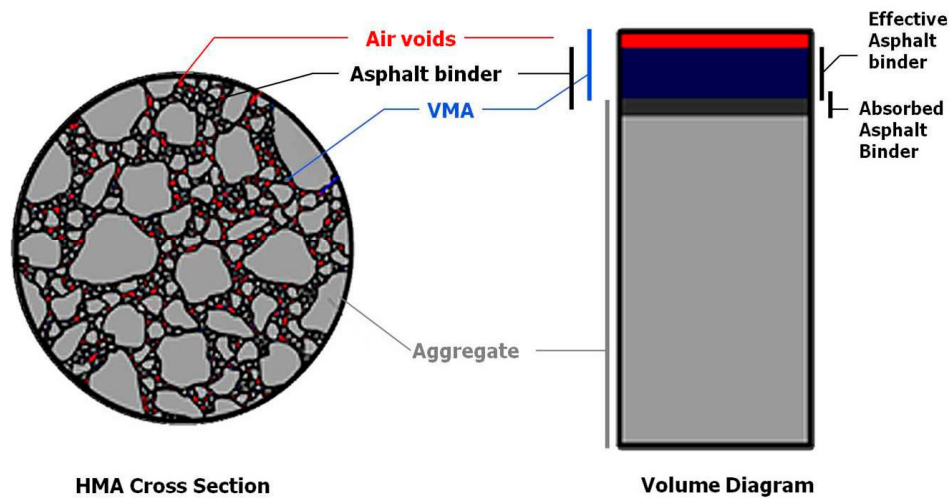

Required Values

The specific gravities listed in Table 1 and the percent by mass of each of the components in the asphalt mixture are needed to determine the volumetric properties. Other values required are also listed. Some of these values are obtained from the JMF and some are measured from a plant produced asphalt mixture sample.

Table 1

Data	Test Method	Obtained
G _{sb} - combined aggregate bulk specific gravity	AASHTO T 84 / T 85 or agency approved test method	JMF or performed at the beginning of placement
G _b – measured specific gravity of the asphalt binder	AASHTO T 228	JMF or from the supplier
G _{mm} – measured maximum specific gravity of the loose mix	FOP for AASHTO T 209	Performed on the field test sample
G _{mb} – measured bulk specific gravity of the compacted paving mix	FOP for AASHTO T 166	Performed on the field compacted specimen
P _b – percent asphalt binder	FOP for AASHTO T 308	Performed on the field test sample
P _{#200} – aggregate passing the #200 (75 μm) sieve	FOP for AASHTO T 30	Performed on the field test sample

Air Voids (V_a)

Air voids are the total volume of the small pockets of air between the coated aggregate particles throughout a compacted paving mixture. Appropriate air voids contribute to the stability of the asphalt mixture and help the pavement withstand the combined action of environment and traffic loads. The designated percent air voids allows for thermal expansion of the asphalt binder and contributes a cushion for future compaction. Air voids are expressed as a percent of the bulk volume of the compacted mixture (G_{mb}) when compared to the maximum specific gravity (G_{mm}).

$$V_a = 100 \left[\frac{(G_{mm} - G_{mb})}{G_{mm}} \right]$$

Where:

V_a = air voids in compacted mixture, percent of total volume (report to 0.1)

G_{mm} = maximum specific gravity of paving mixture (AASHTO T 209)

G_{mb} = bulk specific gravity of compacted mixture (AASHTO T 166)

Percent Aggregate (Stone) (P_s)

P_s is the percent aggregate (stone) content, expressed as a percentage of the total mass of the sample.

$$P_s = 100 - P_b$$

Where:

- P_s = percent aggregate (stone) percent by total weight
 P_b = asphalt binder content (AASHTO T 308)

Voids in the Mineral Aggregate (VMA)

VMA is the volume of intergranular void space between the aggregate particles of the compacted paving mixture that includes the air voids and the effective binder content, expressed as a percent of the total volume of the sample.

$$VMA = 100 - \left[\frac{(G_{mb} \times P_s)}{G_{sb}} \right]$$

Where:

- VMA = voids in mineral aggregate, percent of bulk volume (report to 0.1)
 G_{sb} = bulk specific gravity of combined aggregate (AASHTO T 85 / T 84 or agency approved method from Job Mix Formula)
 G_{mb} = bulk specific gravity of compacted mixture (AASHTO T 166)
 P_s = aggregate content, percent by total weight = $100 - P_b$
 P_b = asphalt binder content (AASHTO T 308) percent by total weight

Voids Filled with Asphalt (binder) (VFA)

VFA is the volume of space between the aggregate particles of the compacted paving mixture filled with asphalt binder, expressed as a percent of the total volume of the sample. The VFA increases as the asphalt binder content increases as it is the percent of voids that are filled with asphalt which doesn't include the absorbed asphalt.

$$VFA = 100 \left[\frac{(VMA - V_a)}{VMA} \right]$$

Where:

- VFA = voids filled with asphalt, percent of VMA (report to 1)
VMA = voids in mineral aggregate, percent of bulk volume
 V_a = air voids in compacted mixture, percent of total volume.

Effective Specific Gravity of the Aggregate (Stone) (G_{se})

The G_{se} is used to quantify the asphalt binder absorbed into the aggregate particle. This is a calculated value based on the specific gravity of the mixture, G_{mm} , and the specific gravity of the asphalt binder, G_b . This measurement includes the volume of the aggregate particle plus the void volume that becomes filled with water during the test soak period minus the volume of the voids that absorb asphalt binder. Effective specific gravity lies between apparent and bulk specific gravity.

G_{se} is formally defined as the ratio of the mass in air of a unit volume of a permeable material (excluding voids permeable to asphalt binder) at a stated temperature to the mass in air (of equal density) of an equal volume of gas-free distilled water at a stated temperature.

$$G_{se} = \frac{P_s}{\left[\left(\frac{100}{G_{mm}} \right) - \left(\frac{P_b}{G_b} \right) \right]}$$

Where:

- G_{se} = effective specific gravity of combined aggregate (report to 0.001)
- P_s = aggregate content, percent by total weight = 100 – P_b
- G_{mm} = maximum specific gravity of mix (AASHTO T 209)
- P_b = asphalt binder content (AASHTO T 308) percent by total weight
- G_b = specific gravity of asphalt binder (JMF or asphalt binder supplier)

Percent of Absorbed (asphalt) Binder (P_{ba})

P_{ba} is the total percent of the asphalt binder that is absorbed into the aggregate, expressed as a percentage of the mass of aggregate rather than as a percentage of the total mass of the mixture. This portion of the asphalt binder content does not contribute to the performance of the mix.

$$P_{ba} = 100 \left[\frac{(G_{se} - G_{sb})}{(G_{sb} \times G_{se})} \right] G_b$$

Where:

- P_{ba} = absorbed asphalt binder (report to 0.01) percent of aggregate
- G_{se} = effective specific gravity of combined aggregate
- G_{sb} = bulk specific gravity of combined aggregate (AASHTO T 85 / T 84 or agency approved method from Job Mix Formula)
- G_b = specific gravity of asphalt binder (JMF or asphalt binder supplier)

Percent of Effective (asphalt) Binder (P_{be})

P_{be} is the total asphalt binder content of a paving mixture minus the portion of asphalt binder that is lost by absorption into the aggregate particles, expressed as a percentage of the mass of aggregate. It is the portion of the asphalt binder content that remains as a coating on the outside of the aggregate particles. This is the asphalt content that controls the performance of the mix.

$$P_{be} = P_b - \left[\frac{P_{ba}}{100} \times P_s \right]$$

Where:

P_{be} = effective asphalt binder content (report to 0.01), percent by total weight

P_s = aggregate content, percent by total weight = 100 – P_b

P_b = asphalt binder content (AASHTO T 308) percent by total weight

P_{ba} = absorbed asphalt binder

Dust Proportion – DP (Dust to Effective (asphalt) Binder Ratio)

The DP is the percent passing the No. 200 sieve of the gradation divided by the percent of effective asphalt binder. Excessive dust reduces asphalt binder film thickness on the aggregate which reduces the durability. Insufficient dust may allow excessive asphalt binder film thickness, which may result in a tender, unstable mix.

$$DP = \frac{P_{\#200}}{P_{be}}$$

Where:

DP = Dust Proportion, (dust-to-binder ratio) (report to 0.01)

$P_{\#200}$ = aggregate passing the #200 (75 μm) sieve, percent by mass of aggregate (AASHTO T 30)

P_{be} = effective asphalt binder content, percent by total weight

Mix Design and Production Values

Job Mix Formula

Table 2 includes example data required from the JMF. Some of these values are used in the example calculations.

Note: Some of the targets may change after the asphalt mixture is in production based on field test data.

Table 2

JMF Data	
Asphalt binder grade	PG 64-28
N _{values}	N _{ini} = 7 N _{des} = 75 N _{max} = 115
G _{sb} (combined specific gravity of the aggregate)	2.678
Target P _b	4.75%
Initial sample mass for gyratory specimens	4840 grams
Mixing temperature range	306 – 312 °F
Laboratory compaction temperature range	286 – 294 °F
G _b (specific gravity of the asphalt binder)	1.020
Target gradation	
Sieve Size mm (in.)	Percent Passing
19.0 (3/4)	100
12.5 (1/2)	85
9.5 (3/8)	80
4.75 (No. 4)	50
2.36 (No. 8)	30
0.18 (No. 16)	25
0.600 (No. 30)	15
0.300 (No. 50)	10
0.150 (No. 100)	7
75 μm (No. 200)	5.0

Sample Test Result

Tables 3 and 4 include data from test results performed on a field sample of asphalt mixture used in the example calculations.

Table 3

Field Data		
	Test method	Example values
P _b	FOP for AASHTO T 308	4.60%
G _{mb}	FOP for AASHTO T 166	2.415
G _{mm}	FOP for AASHTO T 209	2.516

Table 4

Sieve Analysis FOP for AASHTO T 30	
Sieve Size mm (in.)	Percent Passing
19.0 (3/4)	100
12.5 (1/2)	86
9.5 (3/8)	77
4.75 (No. 4)	51
2.36 (No. 8)	34
01.18 (No. 16)	23
0.600 (No. 30)	16
0.300 (No. 50)	12
0.150 (No. 100)	8
75 μm (No. 200)	4.9

Sample Calculations

Air Voids (V_a)

$$V_a = 100 \left[\frac{(G_{mm} - G_{mb})}{G_{mm}} \right]$$

$$V_a = 100 \left[\frac{(2.516 - 2.415)}{2.516} \right] = 4.01431\% \text{ report } 4.0\%$$

Given:

$$G_{mm} = 2.516$$

$$G_{mb} = 2.415$$

Percent Aggregate (Stone) (P_s)

$$P_s = 100 - P_b$$

$$P_s = 100.0 - 4.60\% = 95.40\%$$

Given:

$$P_b = 4.60\%$$

Voids in the Mineral Aggregate (VMA)

$$VMA = 100 - \left[\frac{(G_{mb} \times P_s)}{G_{sb}} \right]$$

$$VMA = 100.0 - \left[\frac{(2.415 \times 95.40\%)}{2.678} \right] = 13.96\% \text{ report } 14.0\%$$

Given:

$$G_{sb} = 2.678$$

Voids Filled with Asphalt (binder) (VFA)

$$VFA = 100 \left[\frac{(VMA - V_a)}{VMA} \right]$$

$$VFA = 100 \left[\frac{(14.0\% - 4.0\%)}{14.0\%} \right] = 71.4\% \text{ report } 71\%$$

Effective Specific Gravity of the Aggregate (Stone) (G_{se})

$$G_{se} = \frac{P_s}{\left[\left(\frac{100}{G_{mm}}\right) - \left(\frac{P_b}{G_b}\right)\right]}$$

$$G_{se} = \frac{(100 - 4.60\%)}{\left[\left(\frac{100}{2.516}\right) - \left(\frac{4.60\%}{1.020}\right)\right]} =$$

$$G_{se} = \frac{95.40\%}{39.74563 - 4.50980} = 2.70747 \text{ report } 2.707$$

Given:

$$G_b = 1.020$$

Percent of Absorbed (asphalt) Binder (P_{ba})

$$P_{ba} = 100 \left[\frac{(G_{se} - G_{sb})}{(G_{sb} \times G_{se})} \right] G_b$$

$$P_{ba} = 100 \left[\frac{(2.707 - 2.678)}{(2.678 \times 2.707)} \right] 1.020 =$$

$$P_{ba} = 100 \left[\frac{0.0290}{7.24935} \right] 1.020 = 0.40804\% \text{ report } 0.41\%$$

Percent of Effective (asphalt) Binder (P_{be})

$$P_{be} = P_b - \left[\frac{P_{ba}}{100} \times P_s \right]$$

$$P_{be} = 4.60 - \left[\frac{0.41\%}{100} \times (100 - 4.60\%) \right] = 4.20886\% \text{ report } 4.21\%$$

Dust Proportion – DP (Dust to Effective (asphalt) Binder Ratio)

$$DP = \frac{P_{\#200}}{P_{be}}$$

$$DP = \frac{4.9\%}{4.21\%} = 1.16390 \text{ report } 1.16$$

Given:

$$P_{\#200} = 4.9\%$$

Report

- On forms approved by the agency
- Sample ID
- Air Voids, V_a to the nearest 0.1 percent
- Voids in the Mineral Aggregate, VMA to the nearest 0.1 percent
- Voids Filled with Asphalt, VFA to the nearest whole value
- Effective Specific Gravity of Aggregate (stone), G_{sc} to the nearest 0.001
- Percent of Absorbed (asphalt) Binder, P_{ba} to the nearest 0.01
- Percent Effective (asphalt) Binder, P_{be} to the nearest 0.01
- Dust Proportion, DP to the nearest 0.01

Appendix - Formulas

Air Voids (V_a)

$$V_a = 100 \left[\frac{(G_{mm} - G_{mb})}{G_{mm}} \right]$$

Where:

V_a = air voids in compacted mixture, percent of total volume (report to 0.1)

G_{mm} = maximum specific gravity of paving mixture (AASHTO T 209)

G_{mb} = bulk specific gravity of compacted mixture (AASHTO T 166)

Percent Aggregate (Stone) (P_s)

$$P_s = 100 - P_b$$

Where:

P_s = percent aggregate (stone) percent by total weight

P_b = asphalt binder content (AASHTO T 308)

Voids in the Mineral Aggregate (VMA)

$$VMA = 100 - \left[\frac{(G_{mb} \times P_s)}{G_{sb}} \right]$$

Where:

VMA = voids in mineral aggregate, percent of bulk volume (report to 0.1)

G_{sb} = bulk specific gravity of combined aggregate (AASHTO T 85 / T 84 or agency approved method from Job Mix Formula)

G_{mb} = bulk specific gravity of compacted mixture (AASHTO T 166)

P_s = aggregate content, percent by total weight = 100 - P_b

P_b = asphalt binder content (AASHTO T 308) percent by total weight

Voids Filled with Asphalt (binder) (VFA)

$$VFA = 100 \left[\frac{(VMA - V_a)}{VMA} \right]$$

Where:

VFA = voids filled with asphalt, percent of VMA (report to 1)

VMA = voids in mineral aggregate, percent of bulk volume

V_a = air voids in compacted mixture, percent of total volume.

Effective Specific Gravity of the Aggregate (Stone) (G_{se})

$$G_{se} = \frac{P_s}{\left[\left(\frac{100}{G_{mm}}\right) - \left(\frac{P_b}{G_b}\right)\right]}$$

Where:

- G_{se} = effective specific gravity of combined aggregate (report to 0.001)
- P_s = aggregate content, percent by total weight = 100 – P_b
- G_{mm} = maximum specific gravity of mix (AASHTO T 209)
- P_b = asphalt binder content (AASHTO T 308) percent by total weight
- G_b = specific gravity of asphalt binder (JMF or asphalt binder supplier)

Percent of Absorbed (asphalt) Binder (P_{ba})

$$P_{ba} = 100 \left[\frac{(G_{se} - G_{sb})}{(G_{sb} \times G_{se})} \right] G_b$$

Where:

- P_{ba} = absorbed asphalt binder (report to 0.01) percent of aggregate
- G_{se} = effective specific gravity of combined aggregate
- G_{sb} = bulk specific gravity of combined aggregate (AASHTO T 85 from Job Mix Formula)
- G_b = specific gravity of asphalt binder (JMF or asphalt binder supplier)

Percent of Effective (asphalt) Binder (P_{be})

$$P_{be} = P_b - \left[\frac{P_{ba}}{100} \times P_s \right]$$

Where:

- P_{be} = effective asphalt binder content (report to 0.01), percent by total weight
- P_s = aggregate content, percent by total weight = 100 – P_b
- P_b = asphalt binder content (AASHTO T 308) percent by total weight
- P_{ba} = absorbed asphalt binder

Dust Proportion – DP (Dust to Effective (asphalt) Binder Ratio)

$$DP = \frac{P_{\#200}}{P_{be}}$$

Where:

- DP = Dust Proportion, (dust-to-binder ratio) (report to 0.01)
- $P_{\#200}$ = aggregate passing the #200 (75 μ m) sieve, percent by mass of aggregate (AASHTO T 30)
- P_{be} = effective asphalt binder content, percent by total weight

REVIEW / PRATICE Exam for TM 13

**** Only use for review / practice**

1) An asphalt mixture sample was taken from Project 6471: Calculate the Asphalt mixture following properties:

Given:

From the Mix Design:

G _b	1.031
G _{sb} (combined)	2.687

Field Sample:

T 209 G _{mm} average of two samples	2.514
T 166 G _{mb} average of two samples	2.451
T 308 P _b	5.51
T 30 P _{#200}	6.6

All calculations will be carried a minimum of 5 (five) places right of the decimal, all initial formula input data shall use reported data

Rounding: all numbers will be rounded up at 5

Answer and REPORT:

PROPERTY	Answer (5 decimal places)	REPORT
VMA (0.1%)		
V _a (0.1%)		
VFA (1)		
G _{se} (0.001)		
P _{ba} (0.01)		
P _{be} (0.01)		
DP (0.01)		

REVIEW ONLY

REVIEW / PRACTICE Exam for TM 13

Answer Sheet

VMA (0.1%)	13.8
V _a (0.1%)	2.5
VFA (1)	82
G _{se} (0.001)	2.744
P _{ba} (0.01)	0.80
P _{be} (0.01)	4.75
DP (0.01)	1.39

$$VMA = 100 - \left[\frac{2.451 \times 94.49}{2.687} \right] \quad VMA = 100 - \left[\frac{231.59499}{2.687} \right] \quad VMA = 100 - 86.19092$$

$$VMA = 13.80908 \quad \mathbf{VMA = 13.8}$$

$$V_a = 100 \left[\frac{(2.514 - 2.451)}{2.514} \right] \quad V_a = 100 \left[\frac{(0.06300)}{2.537} \right] \quad V_a = 100[0.02506]$$

$$V_a = 2.50597 \quad \mathbf{V_a = 2.5}$$

$$VFA = 100 \left[\frac{(13.8 - 2.5)}{13.8} \right] \quad VFA = 100 \left[\frac{(11.3)}{13.8} \right] \quad VFA = 100[0.81884]$$

$$VFA = 81.88406 \quad \mathbf{VFA = 82}$$

$$G_{se} = \frac{(100 - 5.51)}{\left[\left(\frac{100}{2.514}\right) - \left(\frac{5.51}{1.031}\right)\right]} \quad G_{se} = \frac{(94.49)}{[(39.77725) - (5.34433)]} \quad G_{se} = \frac{94.49}{[34.43292]}$$

$$G_{se} = 2.74418 \quad \mathbf{G_{se} = 2.744}$$

$$P_{ba} = 100 \left[\frac{(2.744 - 2.687)}{(2.687 \times 2.744)} \right] 1.030 \quad P_{ba} = 100 \left[\frac{0.05700}{7.37313} \right] 1.031 \quad P_{ba} = 100[0.00773]1.031$$

$$P_{ba} = 0.79696 \quad \mathbf{P_{ba} = 0.80}$$

$$P_{be} = 5.51 - \left[\frac{0.80}{100} (100 - 5.51) \right] \quad P_{be} = 5.51 - [0.00800 \times 94.49] \quad P_{be} = 5.51 - 0.75592$$

$$P_{be} = 4.75408 \quad \mathbf{P_{be} = 4.75}$$

$$DP = \frac{6.6}{4.75} \quad DP = 1.38947 \quad \mathbf{DP = 1.39}$$

LABORATORY PREPARED ASPHALT MIXTURE SPECIMENS WAQTC TM 14

Significance

The objective of asphalt mixture design is to determine the proper combination of asphalt binder, aggregates, and additives that will provide long lasting performance as part of the pavement structure. Mix designing involves laboratory procedures developed to establish the proper proportion of materials for use in asphalt paving mixtures. Correctly designed asphalt mixtures can be expected to perform successfully for many years.

Scope

This practice covers preparing asphalt mixture samples according to an established job mix formula (JMF). The aggregate, asphalt binder, and additives are proportioned based on the JMF and mixed to produce samples for testing or verification of the JMF. These specimens can be used for determining ignition furnace asphalt binder content and aggregate correction factors, performance testing, and other Quality Assurance measures.

There are several practices for batching material in the laboratory. This procedure covers the Iterative Method of batching material and provides a process for checking the accuracy of the batched test samples by confirming the gradation of a batched test sample.

Terminology

- RAP – Recycled Asphalt Pavement
- RAS – Recycled Asphalt Shingles
- Cold feed – Term used to reference plant settings for percentages of the individual constituents.
- Iterative Method – Batching process that is repeated until the desired gradation is achieved.
- Batch Plan – A mathematical process that assists with the batching of the materials.

Apparatus

- Thermometer(s), or other temperature measuring device(s), with a temperature range of 50-500°F.
- Oven: Capable of maintaining $230 \pm 9^\circ\text{F}$.
- Forced air, ventilated or convection oven: Capable of maintaining the temperature surrounding the sample at $325 \pm 9^\circ\text{F}$.
- Bins, pans, or buckets of adequate size to accommodate fractionated material for each stockpile separated size.
- Labels for each bin that note the aggregate designation and sieve size upon which the material was retained.

- Lids or plastic coverings for bins and buckets to minimize moisture absorption in the fractionated material during storage if necessary.
- Drying/batch containers: Shallow flat metal pans large enough to accommodate a batched sample.
- Balance or scale: Capacity sufficient for the sample mass, accurate to 0.1 percent of the sample mass or readable to 0.1 g
- Sieves: meeting the requirements of the FOP for AASHTO T 27/T 11.
- Mechanical sieve shaker: meeting the requirements of the FOP for AASHTO T 27/T 11.
- Mechanical washing apparatus (optional)
- Suitable drying equipment: meeting the requirements of the FOP for AASHTO T 255.
- Containers: A pan or vessel of a size sufficient to contain the sample covered with water and to permit vigorous agitation without loss of any part of the sample or water.
- Utensils: Spoons, spatulas, brushes, stirring rods, etc.
- Mixer: Of sufficient capacity and design to adequately combine all ingredients.

Material Sampling

1. Obtain representative samples of aggregate, from each stockpile listed on the JMF, according to the FOP for AASHTO R 90.
2. Obtain samples of asphalt binder according to the FOP for AASHTO R 66.
3. Obtain hydrated lime from the supplier listed on the JMF, if used.
4. Obtain anti-stripping agent from the supplier listed on the JMF, if used.
5. Obtain representative recycled material samples, after the material has been processed for hot mix production use, according to FOP for AASHTO R 90, if used.

Note 1: RAP is material recovered from existing roadways during milling operations or pavement removal during construction. Most RAP requires reprocessing to be useable in new asphalt mixtures. Processing may include crushing and screening of the material.

Aggregate Preparation

Obtain quality control gradation reports of the separated sizes or stockpiled materials listed on the JMF. The average gradation, expressed as a percent retained, of each stockpile will be used to verify JMF target gradation. If recycled material (RAP or RAS) is included in the JMF, verify the asphalt binder content and gradation are listed.

The virgin aggregates used in the blend may be batched unwashed or washed, according to agency requirements.

Fractionating of Virgin Aggregate

1. Dry each stockpile sample according to the FOP for AASHTO T 255.
2. After drying, cool and cover, if necessary, to minimize moisture absorption.
3. Select sieves required by the specification. Separate each stockpile sample into individual size fractions according to the FOP for AASHTO T 27/T 11.
4. Carefully empty the material retained on each sieve into a bin, pan, or bucket, and label according to size.

Note 2: To reduce the number of sizes of fractionated aggregates from which the batch is prepared, agencies may allow small amounts to be added from other stockpiles. Stockpiles should meet the criteria in Appendix A, Aggregate Batching.

5. Cover, if necessary, to prevent moisture absorption.

Wash Fractionated Aggregate

When the agency requires, the fractionated aggregate is washed and dried before batching test samples. The adherent fines that are washed out are replaced with material passing the 75 μm (No. 200) sieve during batching.

1. Wash each size of fractionated aggregate according to the FOP for AASHTO T 27/11, except for the material passing the 75 μm (No. 200) sieve or “Dust.”

Note 3: Adherent fines may have different properties than sieved minus 75 μm (No. 200) material.

2. Dry according to the FOP for AASHTO T 255.
3. Store in separate bins or buckets, label according to size and cover, if necessary.

RAP

If RAP, RAS, or both, is included in the JMF:

1. Dry the processed recycled material overnight or to constant mass at $125 \pm 5^\circ\text{F}$.

Note 4: Constant mass is achieved when successive mass determinations do not change more than 0.05 percent after an additional 2 hours of drying.

2. Cover and cool.

Aggregate Batch Plan

Batch plans are developed one virgin aggregate stockpile at a time starting with the coarsest stockpile and progressing through the finer stockpiles.

Determine all masses to the nearest 0.1 percent of the sample mass or to the nearest 0.1 g.

1. Calculate the required mass for each stockpile (virgin stockpile, lime, RAP, etc.) by multiplying the desired sample size by the cold feed percentage for each stockpile and record to the nearest 0.1 g. The sum of the individual masses must add up to the desired total sample mass.
2. Calculate the percent retained for each sieve of the aggregate portions using the control gradation average.

3. Calculate the mass per sieve per stockpile. Start with the coarsest virgin aggregate stockpile, multiply the individual mass for that stockpile by the percent retained on each sieve and record to the nearest 0.1 g.
4. Identify the sieve sizes that material from other stockpiles will be added. Document the mass and the contributing stockpile. See Note 2.
5. Calculate a cumulative mass total beginning with the largest sieve on the coarsest stockpile. Begin the cumulative total on subsequent finer stockpiles with the ending cumulative total from the previous stockpile.

Note 5: Cumulative masses are used so that the balance is not re-zeroed between each addition possibly causing a misrepresentation of the total mass. Repeat with each successive stockpile. If cumulative totals are not used, verify mathematically that the batch plan produces the correct mass of virgin aggregate for each stockpile and the total of all virgin stockpiles.

Verification of Aggregate Batch Plan

When the fractionated aggregate is not washed before batching, the minus 0.075 (No. 200) batch plan mass may need to be adjusted to compensate for adherent fines.

1. Batch the desired sample size according to the batch plan, excluding recycled material, if applicable.

Note 6: Refer to the FOP for AASHTO T 308 Table 1 for recommended sample size.

2. Perform washed sieve analysis according to the FOP for AASHTO T 27/T 11.
3. The batched sample percent passing must agree with the Virgin Blend Percent Passing (JMF) within the tolerances of Table 1. If the variation exceeds the allowable difference, adjust the virgin aggregate portion of the batch plan and reverify.

Table 1
Allowable Differences Between Batched and Actual Gradations

Sieves	Allowable Difference (%Passing)
Larger than No. 8	±1.5%
No. 8 to No. 50	±1.0%
Smaller than No. 50	±0.5%

Aggregate Preparation

1. Batch the number of samples at desired sample size according to the batch plan, excluding recycled material, if applicable.

Hydrated Lime

When hydrated lime is mixed with water before incorporating into the mixture, add to the test samples the night before mixing with asphalt binder (approximately 12 hours).

1. Determine the mass of hydrated lime to be added to the test sample based on the percent required in the JMF. For mixtures with RAP, the percentage is applied to the virgin aggregate only.
2. Weigh out the mass of hydrated lime required for each test sample and store in a closed tin with the test sample.
3. Add the hydrated lime to the test sample in an oven proof container.
4. Using a spoon or spatula, thoroughly stir the lime into the dry aggregate sample.
5. Add sufficient water to thoroughly wet all the aggregate and achieve a “Surface Damp Condition.”
6. Stir the lime, aggregate and water for approximately five minutes to thoroughly combine. Do not lose any fine material. Spatulas and brushes may be used to clean the fine material from the implements. Do not transfer the mixed sample.
7. Place the mixed sample in the oven, set oven temperature in the mixing temperature range.
8. Dry according to the FOP for AASHTO T 255.

Mixing Preparation

1. Heat the mixing equipment such as bowls, mixing paddles, spoons, etc.
2. Heat aggregate samples 20°F above the JMF mixing temperature.

Note 7: Heating aggregate above mixing temperature allows for loss of heat during the addition of the asphalt binder. Over 20 °F higher may burn the asphalt binder when it is added to the hot aggregate.

3. If RAP material is required, heat carefully in a controlled oven for approximately 2 hrs. at $230 \pm 9^\circ\text{F}$.
4. Heat asphalt binder approximately 10°F above the mixing temperature range. Discard unused asphalt binder after the 3 hrs.

Liquid anti-stripping agent

If liquid anti-stripping agent is required:

- a) Determine the mass of anti-stripping agent to be added to the asphalt binder based on the percent required in the JMF. The percentage is applied to the asphalt binder only.
- b) Follow mixing instructions from the anti-stripping agent supplier, as not all products are incorporated in the same manner.

- c) Heat the anti-stripping agent to 125 ± 15 ° F or temperature range from manufacturer labeling.
- d) Determine and record mass of a clean container.
- e) Add asphalt binder, determine and record asphalt binder mass.
- f) Calculate the mass of anti-stripping agent to be added.
- g) Zero the scale and add calculated mass of anti-stripping agent. Record the measured mass of anti-stripping agent.
- h) Discard material if too much anti-stripping agent is added.

Note 8: Use of a small spoon or stirring rod will assist with anti-strip addition.

- i) Stir the combined sample thoroughly with a small spoon or stirring rod.
- j) Loosely place a lid on the container to prevent dissipation of the additive. Do not secure the lid, expansion could cause injury or loss of material.
- k) Place the combined material in an oven at the JMF mixing temperature range. During binder addition ensure product is stirred thoroughly before each use.

Note 9: Because the elastic properties of asphalt binder degrade when held at high temperatures, the asphalt binder must be used within 3 hrs. of achieving the mixing temperature.

Mixing Procedure

1. Prepare an initial specimen at the design asphalt binder content to “butter” the mixing bowl and utensils. Discard the specimen after mixing, scrape the bowl and paddle or whip with a spatula or other suitable tool.
2. Record mass of “battered” bowl, spatula, and paddle or whip.
3. Remove the spatula and paddle or whip; zero the balance with empty bowl. Introduce the aggregate, mix thoroughly with clean, dry spatula or spoon. Record mass of aggregate, M_{agg} .
4. If RAP is required, introduce the hot RAP and mix thoroughly with the virgin aggregate. Record this mass. Determine M_{RAP} by subtracting the M_{agg} from the mass of aggregate and RAP.
5. Form a crater in the center of the material.
6. Calculate M_{binder} .
7. Zero the scale and add calculated mass of asphalt binder. Record the measured mass of asphalt binder added.

Note 10: If too much asphalt binder is added, it may be removed by dipping a corner of a paper towel in the center of the asphalt binder.

8. Thoroughly mix for a minimum of two minutes, by hand or mixer, until asphalt binder is uniformly distributed, and aggregate is completely coated.
9. Stop the mixer, if used.
10. Stir mixture with buttered spatula, scraping the center bottom of the mixing bowl.

11. If the aggregate is not thoroughly coated, continue mixing until completely coated.
 12. Remove mixture from bowl.
 13. Scrape bowl and paddle or whip with buttered spatula. Place all the mixture into a pan.
 14. Record mass of empty bowl, spatula, and paddle or whip. Ensure the combined mass and the mass of the initial buttered bowl and utensils is within 0.10 percent of the sample mass of the mixed sample.
- Note II:* For a 4700 g sample, 0.10% = 4.7 g. and for a 2100 g sample, 0.10% = 2.1 g.
15. Age the mixed specimen according to AASHTO R 30 or agency requirements.
 16. Repeat steps 3 thru 15 for each specimen to be mixed.

Calculations

Trial Batch Plan

Mass of material contributed per stockpile:

$$\text{mass per stockpile} = \text{sample size} \times \text{stockpile}\%$$

Where:

mass per stockpile	=	mass of material from each stockpile in test sample
sample size	=	desired mass of test sample
stockpile%	=	percent of each stockpile in the mixture (JMF)

Mass of material contributed to each sieve per stockpile:

$$\text{mass per stockpile per sieve} = \text{mass per stockpile} \times \% \text{retained per sieve}$$

Where:

mass per stockpile per sieve	=	amount of fractionated aggregate from each stockpile for each sieve size
%retained per sieve	=	percent retained on each sieve (calculated from crushing records)

Anti-stripping agent mass added before heating asphalt binder:

$$M_{\text{additive}} = \% \text{additive} \times M_{\text{heated binder}}$$

M_{additive}	=	mass of anti-stripping agent to be added to the mass of measured asphalt binder
%additive	=	percent of anti-stripping agent, based on mass of asphalt binder, from JMF
$M_{\text{heated binder}}$	=	mass of asphalt binder heated for mixing

Asphalt binder mass

Asphalt binder mass is based on a percent of the mass of “hot” aggregate.

Mixes without RAP

Determine the mass of asphalt binder to be added to a mix without RAP:

$$M_{binder} = \frac{P_b \times M_{agg}}{(100 - P_b)}$$

Where:

M_{binder} = Mass of asphalt binder to be added to the prepared test sample

P_b = Required percent asphalt binder

M_{agg} = Mass of hot test sample

Mixes with RAP

Determine the mass of asphalt binder in the RAP:

$$M_{RAP\ binder} = M_{RAP} \times \frac{P_{bRAP}}{100}$$

Where:

$M_{RAP\ binder}$ = Mass of asphalt binder in the RAP

M_{RAP} = Mass of RAP in sample

P_{bRAP} = Percent of asphalt binder in the RAP

Determine the amount of asphalt binder to be added to mixes with RAP:

$$M_{binder} = \left[P_b \times \frac{(M_{agg} + M_{RAP} - M_{RAP\ binder})}{(100 - P_b)} \right] - M_{RAP\ binder}$$

Asphalt Binder**Anti-stripping agent mass**

$$M_{additive} = \%additive \times M_{binder}$$

$$M_{additive} = 0.25\% \times 850\ g = 2.1\ g$$

Given:

$$\%additive = 0.25\%$$

$$M_{binder} = 850\ g.$$

Asphalt binder mass – mixtures without RAP

$$M_{binder} = \frac{P_b \times M_{agg}}{(100 - P_b)}$$

$$M_{binder} = \frac{6.0\% \times 4500.0 \text{ g}}{(100\% - 6.0\%)} = \frac{2700.0 \text{ g}}{94.0\%} = 287.2 \text{ g}$$

Given:

$$P_b = 6.0\% \text{ from JMF}$$

$$M_{agg} = 4500.0 \text{ g hot aggregate}$$

Note 13: A factor can be determined for subsequent specimens by taking P_b divided by $100 - P_b$. Then the hot aggregate mass is multiplied by this factor for an expedient oil add determination.

Asphalt binder mass – mixtures with RAP

Determine mass of asphalt binder in RAP:

$$M_{RAP \text{ binder}} = M_{RAP} \times \frac{P_{bRAP}}{100}$$

$$M_{RAP \text{ binder}} = 1125.0 \text{ g} \times \frac{4.88\%}{100} = 54.9 \text{ g}$$

Given:

$$M_{RAP} = 1125.0 \text{ g}$$

$$P_{bRAP} = 4.88\%$$

Determine mass of asphalt binder:

$$M_{binder} = \left[P_b \times \frac{(M_{agg} + M_{RAP} - M_{RAP \text{ binder}})}{(100 - P_b)} \right] - M_{RAP \text{ binder}}$$

$$Mass_{binder} = \left[6.0\% \times \frac{(4500 \text{ g} - 54.9 \text{ g})}{(100\% - 6.0\%)} \right] - 54.9 \text{ g} = 228.8 \text{ g}$$

$$P_b = 6.0 \text{ percent from JMF}$$

$$M_{agg} = 3375.0 \text{ g}$$

$$M_{agg} + M_{RAP} = 4500.0 \text{ g hot aggregate and RAP}$$

Check of Calculation

$$\left[\frac{(54.9g + 228.8g)}{(4500g + 228.8g)} \right] \times 100 = 6.0\%$$

Report

- Project name
- Date of batching
- Specimen identification
- Virgin aggregate mass
- RAP mass, if required
- Percentage of asphalt binder in specimen, nearest 0.1 percent
- Asphalt binder mass
- Anti-Strip mass, if applicable
- Conditioning process

APPENDIX—AGGREGATE BATCHING

(Non-Mandatory Information)

The following guidelines should be considered when batching virgin aggregates that have small amounts of retained material that are encountered during the separation phase and will reduce the number of containers required for material storage:

- The percent retained for the sieve to be moved is less than 10 percent. Material meeting this condition must have a retained like size on the next stockpile or batching of the separated size will be required.
- Stockpiles to be combined are from the same source and same parent material. Aggregates from different sources should not be combined.
- The particle shape and texture are essentially the same for the sieve sizes to be combined.

Stockpiles are produced using similar processes (e.g. do not mix stockpiles of crushed material with stockpiles of uncrushed material; do not mix unwashed stockpiles with washed stockpiles, etc.).

Example

Batch a gyratory sample of 4750 g. of asphalt mixture, the aggregate portion will be about 4500 g. The mixture is to have 25 percent RAP with three virgin stockpiles of 18, 27, and 30 percent.

Batch Mass for the 12.5 to 4.75 mm (1/2 in. to No. 4) stockpile

$$\text{Required mass} = 4500 \text{ g} \times \frac{18\%}{100} = 810.0 \text{ g}$$

Stockpile	12.5 to 4.75 mm (1/2 in. to No. 4)	4.75 to 1.18 mm (No. 4 to No. 8)	4.75 to 1.18 mm (No. 4 to No. 8)	RAP
Cold feed %	18%	27%	30%	25%
Batch Mass	810.0 g.	1215.0 g	1350.0 g	1125.0 g

The sum of the batch masses must add up to the original aggregate target mass, in this example: 810.0 g + 1215.0 g + 1350.0 g + 1125.0 g = 4500.0 g.

Mass per sieve for 12.5 to 4.75 mm (1/2 in. to No. 4) stockpile

Sieve Size mm (in.)	%Retained	Batch Mass g	Mass Carried to Next Pile g	Cumulative Batch Mass g
25 (1)	0.0	0.0	0.0	0.0
19.0 (3/4)	0.0	0.0	0.0	0.0
12.5 (1/2)	3.3	26.7	0.0	26.7
9.5 (3/8)	49.4	400.1	0.0	426.8
6.25 (1/4)	39.8	322.4	0.0	749.2
4.75 (No. 4)	3.5	28.4	-28.4	
2.36 (No. 8)	1.7	13.8	-13.8	
1.18 (No. 16)	0.2	1.6	-1.6	
0.600 (No. 30)	0.0	0.0	0.0	
0.300 (No. 50)	0.1	0.8	-0.8	
0.150 (No. 100)	0.0	0.0	0.0	
0.075 (No. 200)	0.0	0.0	0.0	
Minus 0.075 (No. 200)	2.0	16.2	-16.2	
Total	100.0	810.0	-60.8	

The %Retained column must equal 100.0 percent. The Batch Mass Column should equal 810.0 g.

The Total Batch Mass plus the Mass Carried to Next Pile for sieves smaller than the 6.25 mm (1/4 in.) is 810.0 g + (- 60.8 g) = 749.2 g.

The minus sign shows mass is being removed from this portion of the Batch Plan. It will be added to the next (pile plus sign).

Note 12: Carrying minor amounts of material when batching as in this example reduces the number of fractionated sizes. In case, there are eight less bins from just this stockpile.

The material retained on the 12.5 mm (1/2 in) was 3.3 % and meets the less than 10 percent requirement but doesn't have a like material in the next stockpile, so it must be batched.

Continue with the next stockpile, 4.75 to 1.18 mm (No. 4 to No. 8).

Mass per sieve for 4.75 to 1.18 mm (No. 4 to No. 8) stockpile

Sieve Size mm (in.)	%Retained	Batch Mass g	Mass Carried to Next Pile g	Cumulative Batch Mass g
25 (1)	0.0	0.0	0.0	749.2
19.0 (3/4)	0.0	0.0	0.0	
12.5 (1/2)	0.0	0.0	0.0	
9.5 (3/8)	1.3	15.8	0.0	765.0
6.25 (1/4)	29.5	358.4	0.0	1123.4
4.75 (No. 4)	28.4	345.1 + 28.4	0.0	1496.9
2.36 (No. 8)	32.4	393.7 + 13.8	0.0	1904.4
1.18 (No. 16)	4.1	49.8 + 1.6	-51.4	
0.600 (No. 30)	1.1	13.4 + 0.0	-13.4	
0.300 (No. 50)	0.6	7.3 + 0.8	-8.1	
0.150 (No. 100)	0.3	3.6 + 0.0	-3.6	
0.075 (No. 200)	0.0	0.0 + 0.0	0.0	
Minus 0.075 (No. 200)	2.3	27.9 + 16.2	-44.1	
Total	100.0	1215.0 + 60.8	-120.6	

%Retained equals 100.0, the batch mass equals the 1215.0 g. with 60.8 g. being carried from the 12.5 to 4.75 mm (1/2 in. to No. 4).

Mass per sieve for 44.75 to 1.18 mm (No. 4 to No. 8) stockpile

Sieve Size mm (in.)	Adjusted QL %Retained	Batch Mass g	Cumulative Batch Mass g
25 (1)	0.0	0.0	1904.4
19.0 (3/4)	0.0	0.0	
12.5 (1/2)	0.0	0.0	
9.5 (3/8)	0.0	0.0	
6.25 (1/4)	0.0	0.0	
4.75 (No. 4)	0.2	2.7	1907.1
2.36 (No. 8)	20.2	272.7	2179.8
1.18 (No. 16)	26.5	357.8 + 51.4	2589.0
0.600 (No. 30)	17.1	230.8 + 13.4	2833.2
0.300 (No. 50)	14.8	199.8 + 8.1	3041.1
0.150 (No. 100)	11.9	160.7 + 3.6	3205.4
0.075 (No. 200)	2.8	37.8 + 0.0	3243.2
Minus 0.075 (No. 200)	6.5	87.7 + 44.1	3375.0
Total	100.0	1350.0 + 120.6	

The final Cumulative Batch Mass matches the sum of the three virgin stockpiles, 810.0 + 1215.0 + 1350.0 = 3375.0.

Performance Exam Checklist

Laboratory Prepared Asphalt Mixture Specimens

WAQTC TM 14

Participant Name _____ Exam Date _____

Record the symbols "P" for passing or "F" for failing on each step of the checklist.

Procedure Element	Trial 1	Trial 2
1. The tester has a copy of the current procedure on hand?	_____	_____
2. All equipment is functioning according to the test procedure, and if required, has the current calibration/standardization/check tags present?	_____	_____
3. Representative samples of aggregate identified on JMF obtained per FOP for AASHTO R 90?	_____	_____
4. Representative samples of asphalt binder identified on JMF obtained per FOP for AASHTO R 66?	_____	_____
5. If required, hydrated lime obtained from supplier?	_____	_____
6. If required, anti-stripping agent obtained from supplier?	_____	_____
7. If required, representative samples of recycled material (RAP, RAS) sufficient for production use obtained per FOP for AASHTO R 90?	_____	_____
Aggregate Preparation		
8. Aggregate dried according to FOP for AASHTO T 255?	_____	_____
9. Aggregate separated into individual size fractions according to FOP for AASHTO T 27_T 11?	_____	_____
10. Material retained on each sieve placed in separate containers?	_____	_____
11. Separated aggregates washed, except the portion passing the No. 200 (0.075 mm) sieve, in accordance with FOP for AASHTO T 27_T 11?	_____	_____
12. Washed aggregate samples dried according to FOP for AASHTO T 255?	_____	_____
13. If required, recycled material (RAP, RAS) dried overnight or to constant mass at $125 \pm 5^{\circ}\text{F}$?	_____	_____
14. All dried and cooled material stored as necessary to prevent moisture absorption?	_____	_____

Procedure Element	Trial 1	Trial 2
Mixing Preparation		
15. Aggregate batch plan developed off JMF and calculated based on cumulative totals?	_____	_____
16. Number of samples at desired sample size determined by the specific test procedure to be performed?	_____	_____
17. Mixing equipment (bowls, mixing paddles, spoons/scrapers, etc.) heated?	_____	_____
18. Aggregate heated 20°F above JMF mixing temperature?	_____	_____
19. If required, RAP material carefully heated for approximately 2 hrs. at 230 ± 9°F?	_____	_____
20. Asphalt binder heated 10°F above JMF mixing temperature?	_____	_____
21. If required, liquid anti-stripping agent incorporated as instructed by supplier or as defined in step 4. a) – k)?	_____	_____
Mixing Procedure		
22. A prepared specimen used to butter all mixing equipment and discarded?	_____	_____
23. Mass of buttered bowl and paddle recorded?	_____	_____
24. Heated aggregate introduced into tared empty bowl and mixed thoroughly?	_____	_____
25. Mass of aggregate recorded?	_____	_____
26. If required, RAP material introduced with heated aggregate and mixed thoroughly?	_____	_____
27. Mass of RAP recorded?	_____	_____
28. Crater formed?	_____	_____
29. Scale tared and calculated mass of asphalt binder added?	_____	_____
30. All material thoroughly mixed for a minimum of two minutes or until completely coated?	_____	_____
31. All mixture placed into pan and mixing equipment scraped back to buttered condition?	_____	_____
32. Mass of empty bowl and paddle recorded and not more than 0.10 percent of total sample mass has been gained or loss?	_____	_____
33. If required, mixture specimen aged according to AASHTO R 30?	_____	_____
34. Steps repeated for each specimen to be mixed?	_____	_____
35. All calculations performed correctly?	_____	_____

Tester qualified in performing TM14 Gyrotory samples. Date: _____

Tester qualified in performing TM14 including RAP/RAS. Date: _____

Tester qualified in performing TM14 HWTD/IDT/Ideal CT. Date: _____

Tester qualified in performing TM14 to include Anti-strip. Date: _____

Tester qualified in performing TM14 Rice samples. Date: _____

Tester qualified in performing TM14 IFCF samples. Date: _____

First Attempt: Pass Fail

Second Attempt: Pass Fail

Signature of Examiner _____ WAQTC #: _____

Comments:

WSDOT Errata to WAQTC TM 15

Laboratory Theoretical Maximum Dry Density of Granular Soil and Soil/Aggregate

WAQTC TM 15 has been adopted by WSDOT with the following changes:

Apparatus

Replace with below:

- **Small Mold Assembly:** includes mold, mold base, and mold follower.
 - **Mold Follower:** Steel plate, with a 12 ± 1 mm (0.460 ± 0.03 in.) edge thickness fitting inside the mold with 1.5 mm (0.063 in.) maximum space between mold follower and mold wall. For new followers, the diameter tolerance is - 1 mm to - 2 mm (- 0.031 in. to - 0.063 in.) of the inside diameter of the matching mold.

In-service followers shall have a minimum edge thickness of 10.7 mm (0.420 in.).

- **Large Mold Assembly:** includes mold, mold base, and mold follower
 - **Mold Follower:** Steel plate, with 14 ± 1 mm (0.550 ± 0.030 in.) edge thickness fitting inside the mold with 1.5 mm (0.063 in.) max. space between mold follower and mold wall. For new followers, the diameter tolerance is - 1 mm to - 2 mm (- 0.031 in. to - 0.063 in.) of the inside diameter of the matching mold.

In-service followers shall have a minimum edge thickness of 12.6 mm (0.496 in.).

Sample Preparation

Replace step one with below:

1. Obtain a representative sample according to Table 3 below.

Table 3 TM15 Sample Size		
	Minimum Mass lb (kg)	
If no more than 15 percent by weight of aggregate exceeds 19 mm (¾ in.)	210	95
If 15 percent or more by weight of aggregate exceeds 19 mm (¾ in.)	330	150

Theoretical Maximum Density Curve Development

Replace with below:

WSDOT Employees – Enter laboratory data into MATS to develop the maximum density chart and maximum density curve.

Non-WSDOT Employees – Enter laboratory data into WAQTC spreadsheet to develop the maximum density chart and maximum density curve. Spreadsheet available at

<http://waqtc.org/library/library.cfm>

LABORATORY THEORETICAL MAXIMUM DRY DENSITY OF GRANULAR SOIL AND SOIL/ AGGREGATE WAQTC TM 15

Scope

This method is used to establish the theoretical maximum dry density of granular and non-granular soil-aggregate. Use Procedure 1 for material with more than 30 percent retained on the 4.75 mm (No. 4) sieve or Procedure 2 for material with more than 30 percent retained on the 19.0 mm (¾ in.) sieve.

Terminology

- Fine aggregate portion – material passing the 4.75 mm (No. 4) Sieve.
- Coarse aggregate portion – material retained on the 4.75 mm (No. 4) sieve.

Significance

A theoretical maximum dry density chart and curve are developed by determining a laboratory maximum dry density of a representative sample of material passing the 4.75 mm (No. 4) and the material retained on the 4.75 mm (No. 4), and their respective apparent specific gravities (G_{sa}). The theoretical maximum dry density chart and curve address the range of theoretical maximum dry densities due to fluctuations in coarse and fine aggregate of a given material.

To determine the laboratory maximum dry density of the fine aggregate portion, this method allows for use of the FOP for AASHTO T 99/T 180 or by vibratory compactor covered in the method.

This method is for use on granular materials having 30 to 70 percent passing the 4.75 mm (No. 4) or 19.0 mm (¾ in.) sieve.

Apparatus

- A vibratory spring-loaded compactor – D G Parrott & Son Humphres Maximum Density machine, or equivalent.
- Small Mold Assembly: includes mold, mold base, and mold follower.
 - Mold: approximately 0.003 m³ (0.1 ft.³) volume. Made of steel tubing meeting ASTM A513 with a 165 mm (6.500 in.) nominal outside diameter, 6 mm (0.250 in.) wall thickness, 152 ±1 mm (6 ±0.03 in.) inside diameter, and a height of 203 ±1 mm (8 ±0.032 in.). For in-service molds, do not to exceed 15 mm (6.060 in.) inside diameter.
 - Mold Base: 16 mm (0.625 in.) steel plate separate from the mold. Grind both surfaces to 15 ±1 mm (0.600 ±0.030 in.) thickness.

- Mold Follower: Steel plate, with a 12 ± 1 mm (0.460 ± 0.03 in.) edge thickness fitting inside the mold with 1.5 mm (0.063 in.) maximum space between mold follower and mold wall. For new followers, the diameter tolerance is – 1 mm to – 2 mm (– 0.031 in. to – 0.063 in.) of the inside diameter of the matching mold.
- Large Mold Assembly: includes mold, mold base, and mold follower
 - Mold: approximately 0.014 m³ (0.5 ft.³) volume. Made of steel tubing meeting ASTM A513 with a 267 mm (10.500 in.) nominal outside diameter, 6 mm (0.250 in.) wall thickness, 254 ± 1 mm (10 ± 0.032 in.) inside diameter, and a height of 254 ± 1 mm (10 ± 0.032 in.). For in-service molds, do not to exceed 256 mm (10.060 in.) inside diameter.
 - Mold Base: 6 to 8 mm (0.250 to 0.312 in.) steel plate skip welded or fully welded to the mold.
 - Mold Follower: Steel plate, with 14 ± 1 mm (0.550 ± 0.030 in.) edge thickness fitting inside the mold with 1.5 mm (0.063 in.) max. space between mold follower and mold wall. For new followers, the diameter tolerance is – 1 mm to – 2 mm (– 0.031 in. to – 0.063 in.) of the inside diameter of the matching mold.
- Manually operated rammer: 2.5 kg (5.5 lb.) rammer meeting the requirements of the FOP for AASHTO T 99/T 180.
- Measuring device: minimum length 150 mm (6 in.), accurate and readable to 0.25 mm (0.01 in.)
- Sieves: 75 mm (3 in.), 19 mm ($\frac{3}{4}$ in.), and a 4.75 mm (No. 4) conforming to the FOP for AASHTO T 27/T 11
- Balance or Scale: Capacity sufficient for the principal sample mass, readable to 0.1 percent or 0.1 g, and meeting the requirements of AASHTO M 231
- Tamping rod: straight steel, 16 mm ($\frac{5}{8}$ in.) in diameter and approximately 400 mm (24 in.) long having at least one end rounded to a hemispherical tip
- Straight edge: at least 25 mm (1 in.) longer than the diameter of the mold
- A stopwatch or timer readable to 1 second
- Miscellaneous tools including pans, spoon, trowel, mechanical mixer (optional), etc.

Laboratory Maximum Dry Density

Select the proper method for determining the laboratory maximum dry density of the fine aggregate portion of the sample, refer to Table 1, or as directed by the agency.

Select the proper method for determining the laboratory maximum dry density of the coarse aggregate portion of the sample, refer to Table 2.

Table 1
Fine Aggregate Portion Laboratory Maximum Dry Density Method

Estimated Soil Type	Recommended Test Method
Sandy, non-plastic, permeable soil or non-cohesive soil.	WAQTC TM 15 Vibratory Compactor
Silt, some plasticity, low permeability.	FOP for AASTHO T 99/T 180, T 99 Method A
Sandy/silt, some plasticity, permeable.	WAQTC TM 15 and FOP for AASTHO T 99/T 180, T 99 Method A (use highest results)

Table 2
Coarse Aggregate Portion Laboratory Maximum Dry Density Method

Coarse Aggregate Amount	Test Method
No more than 15 percent by weight of the original aggregate specimen exceeds 19 mm ($\frac{3}{4}$ in.)	WAQTC TM 15 Vibratory Compactor Procedure 1
15 percent or more by weight of the original aggregate specimen is greater than 19 mm ($\frac{3}{4}$ in.) but does not exceed 75 mm (3 in.)	WAQTC TM 15 Vibratory Compactor Procedure 2

Sample Preparation

1. Obtain a representative sample according to the FOP for AASTHO R 90, minimum 180 kg. (400 lbs.).
2. Reduce according to the FOP for AASTHO R 76 to a sufficient size to yield amounts required in steps 7 and 8.
3. If the sample is damp, dry until it becomes friable under a trowel. Drying may be in air or by use of a drying apparatus maintained at a temperature not exceeding 60°C (140°F).
4. Thoroughly break up aggregations in a manner that avoids reducing the natural size of individual particles.

5. Remove the material retained on the 75 mm (3 in.) sieve.
6. Separate into coarse and fine aggregate portions by passing the remainder of the sample through the 4.75 mm (No. 4) sieve.
7. Fine aggregate:
 - a. Obtain a representative sample as described in the FOP for AASHTO T 99/T 180, T 99 Method A.

Or
 - b. Obtain at least three representative test samples of approximately 6 kg (13 lb.) each for the fine aggregate vibratory compactor method.
 - c. Obtain a representative sample of the remaining material and determine the apparent specific gravity (G_{sa}) according to AASHTO T 84 or Annex B.
8. Coarse aggregate:
 - a. Obtain a representative sample of 19 mm ($\frac{3}{4}$ in) to 4.75 mm (No. 4) of approximately 5 kg (11 lb.) for coarse aggregate vibratory compactor Procedure 1.

Or
 - b. Obtain a representative sample of 75 mm (3 in) to 4.75 mm (No. 4) of approximately 20 kg (45 lb.) for coarse aggregate vibratory compactor Procedure 2.
 - c. Obtain a representative sample of the remaining material and determine the apparent specific gravity (G_{sa}) according to FOP for AASHTO T 85 or Annex B.

Laboratory Maximum Dry Density of Fine Aggregate Portion

Determine laboratory maximum dry density of the fine aggregate portion according to the FOP for AASHTO T 180/T 99, T 99 Method A, or the following vibratory compactor method. Refer to Table 1.

Vibratory Compactor Method

1. Determine and record the mass of the clean dry small mold assembly to the nearest 5 g (0.01 lb.). Designate this mass as the M_m .
2. Add enough water to one of the fine aggregate portions to saturate the sample, approximately optimum moisture. Do not over saturate (Note 1).

Note 1: The sample is considered saturated when one to two drops of free water are visible at the base of the mold assembly at the end of the first 2-minute load cycle, Table 3. Refer to Step 11.

3. Mix until homogenous.

4. Place approximately one third of the sample in the mold with mold base attached.
5. Consolidate with 25 strokes of the tamping rod, distribute evenly over the surface, and 25 blows of the manually operated rammer.
6. Repeat Steps 4 and 5 for two subsequent lifts. The surface of the top lift should be finished as level as possible.
7. Place the follower on top of the molded specimen and mount the mold assembly on the jack platform in the compactor. Use spacers between the load spring assembly and follower to adjust the elevation of the mold assembly so the hammers strike near the center of the mass of material in the mold assembly.
8. Elevate the mold assembly with the jack until the load spring assembly seats on top of the follower and apply an initial seating load of approximately 100 lb_f on the sample.
9. Start the compactor hammers. Continue to elevate the mold assembly, applying the load gradually over the time stated in the Table 3.

Table 3
Load Application Rate

Load lb _f	Time
0 to 500	1 min.
500 to 1,000	30 sec.
1,000 to 2,000	30 sec.

10. Upon reaching 2,000 lb_f at the end of the 2-minute cycle, stop the hammer, release the load on the jack, and return to zero pressure.
11. Determine apparent moisture.
 - a. If the material is pumping around the mold follower or excessive amounts of water are seeping from between the mold and mold base, prepare a new sample and begin the test again at Step 1.
 - b. If the base of the mold is dry or there is a small amount of water, repeat Steps 7 through 10, four additional times.
12. Remove the mold assembly from the compactor.
13. Measure the height of the compacted specimen.
 - a. Lay the straight edge across the top of the mold assembly.

- b. Using the measuring device, measure from the bottom of the straight edge to the top of the follower and spacers to the nearest 0.1 mm (0.01 in.). Designate as D .
 - c. Calculate and record the height of the compacted specimen, h_s , by subtracting D and T (thickness of the follower) from the height of the mold h_m . See Annex A..
14. Determine and record the mass of the mold assembly and specimen, M_{ms} , to the nearest 5 g (0.01 lb.).
 15. Determine and record the mass of the specimen, M_s , by subtracting M_m from M_{ms} .
 16. Remove the specimen from the mold assembly.
 17. Use the entire specimen for a moisture content sample or obtain a representative sample by slicing vertically through the center of the specimen. Obtain at least 500 g (1.1 lb.) from one of the cut faces, ensuring that all the layers are represented. If a vertical face does not exist, take a representative sample.

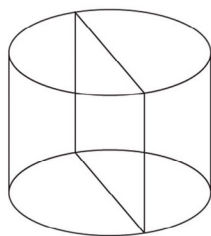

Slice through the center

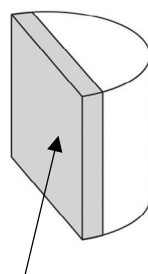
Representative moisture
content sample

18. Determine and record the moisture content, w , according to the FOP for AASHTO T 255/T 265.
19. Calculate and record the wet density, ρ_w , of the fine aggregate portion.
20. Calculate and record the laboratory dry density, ρ_d , of the fine aggregate portion.

Laboratory Maximum Dry Density of the Coarse Portion

Vibratory Compactor Method

Note 2: Procedure 1 uses the small mold assembly, this procedure is not recommended for material with aggregate larger than 9.3 mm (3/4 in.).

Procedure 1

1. Determine and record the mass of the small mold assembly to the nearest 5 g (0.01 lb.). Designate this mass as the M_m .

2. Determine and record the mass of the coarse aggregate portion to the nearest 5 g (0.01 lb.). Designate this mass as the M_s . See Note 3.

Note 3: If all the coarse aggregate portion does not fit in the mold assembly or there is some indication that material may have been lost, perform alternate Step 16 to determine M_s .

3. Determine amount of water to add to the coarse aggregate portion by multiplying the mass determined in Step 2 by 0.025 (2.5 percent).
4. Add water to coarse aggregate portion, mix thoroughly.
5. Place approximately one third of the sample in the mold with mold base attached.
6. Tamp the surface lightly with the manually operated rammer to consolidate material and achieve a level surface.
7. Repeat Steps 5 and 6 for two subsequent lifts. Ensure all the coarse aggregate portion is placed in the mold.
8. Place the follower on top of the molded specimen and mount the mold assembly on the jack platform in the compactor. Use spacers between the load spring assembly and follower to adjust the elevation of the mold assembly so the hammers strike near the center of the mass of material in the mold assembly.
9. Elevate the mold assembly with the jack until the loading spring assembly seats on top of the follower and spacers.
10. Apply an initial seating load of approximately 100 lbf on the sample.
11. Start the compactor hammers. Continue to elevate the mold, applying the load gradually over the time stated in the Table 3.
12. Upon reaching the 2,000 lbf load at the end of the 2-minute cycle, stop the hammer, release the load on the jack, and return to zero pressure.
13. Repeat Steps 10 through 12 four additional times.
14. Remove the mold assembly from the compactor.
15. Measure the height of the compacted specimen.
 - a. Lay the straight edge across the top of the mold assembly.
 - b. Using the measuring device, measure from the bottom of the straight edge to the top of the follower and spacers to the nearest 0.1 mm (0.01 in.). Designate as D .
 - c. Calculate and record the height of the compacted specimen, h_s , by subtracting D and T (thickness of the follower) from the height of the mold h_m . See Annex A.

16. Alternate method of determining M_s

- a. Remove the specimen from the mold assembly.
- b. Determine the dry mass according to the FOP for AASHTO T 255. Designate as M_s .

17. Calculate and record the laboratory dry density, ρ_d , of the coarse aggregate portion.**Procedure 2**

1. Determine and record the mass of the large mold assembly to the nearest 5 g (0.01 lb.). Designate this mass as the M_m .
2. Determine and record the mass of the coarse aggregate portion to the nearest 5 g (0.01 lb.). Designate this mass as the M_s .

Note 4: If all the coarse aggregate portion does not fit in the mold or there is some indication that material may have been lost, perform alternate Step 13 to determine M_s .

3. Place approximately one fifth of the sample in the large mold with mold base.
4. Tamp the surface lightly with the manually operated rammer to consolidate material and achieve a level surface.
5. Place the follower on top of the molded specimen and mount the mold assembly on the jack platform in the compactor. Use spacers between the load spring assembly and follower to adjust the elevation of the mold assembly so the hammers strike near the center of the mass of material in the mold assembly.
6. Elevate the mold assembly with the jack until the loading spring assembly seats on top of the follower.
7. Apply an initial seating load of approximately 100 lbf on the sample.
8. Start the compactor hammers. Continue to elevate the mold assembly, applying the load gradually over the time stated in the Table 3.
9. Upon reaching the 2,000 lbf load at the end of the 2-minute cycle, stop the hammer, release the load on the jack, and return to zero pressure.
10. Repeat Steps 3 through 9 four additional times. Ensure all the coarse aggregate portion is placed in the mold on the final lift.
11. Remove the mold assembly from the compactor.
12. Measure the height of the compacted specimen.
 - a. Lay the straight edge across the top of the mold assembly.

- b. Using the measuring device, measure from the bottom of the straight edge to the top of the follower and spacers to the nearest 0.1 mm (0.01 in.). Designate as D.
- c. Calculate and record the height of the compacted specimen, h_s , by subtracting D and T (thickness of follower) from the height of the mold, h_m . See Annex A.

13. Alternate method of determining M_s

- a. Remove the specimen from the mold assembly.
- b. Determine the dry mass of the specimen according to the FOP for AASHTO T 255. Designate as M_s .

14. Calculate and record the laboratory dry density, ρ_d , of the coarse aggregate portion.

Calculations

Height of specimen in mold (fine or coarse aggregate portion)

$$h_s = h_m - D - T$$

where:

- | | | |
|-------|---|--|
| h_s | = | height of specimen in mold, 0.1 mm (0.01 in.) |
| h_m | = | height of mold, 0.1 mm (0.01 in.), Annex A |
| D | = | measured distance from the mold top to the follower, 0.1 mm (0.01 in.) |
| T | = | thickness of the follower, 0.1 mm (0.01 in.), Annex A |

Volume of the specimen in the mold (fine or coarse aggregate portion)

$$V_s = \frac{h_s \times \pi \times \left(\frac{d}{2}\right)^2}{1e^9 \text{ mm}^3 / \text{m}^3 \text{ or } 1728 \text{ in}^3 / \text{ft}^3}$$

where:

- | | | |
|-------|---|---|
| V_s | = | volume of specimen in mold m^3 (ft^3) |
| d | = | inside diameter of the mold, 0.1 mm (0.01 in.), Annex A |

Mass of fine aggregate portion in the mold assembly

$$M_s = M_{ms} - M_m$$

where:

- M_s = mass of specimen in mold assembly, 0.005 kg (0.01 lb.)
 M_{ms} = mass of mold assembly and specimen, 0.005 kg (0.01 lb.)
 M_m = mass of mold assembly, 0.005 kg (0.01 lb.)

Wet Density of fine aggregate portion

$$\rho_w = \frac{M_s}{V_s}$$

Where:

- ρ_w = wet density, kg/m³ (lb/ft³)
 M_s = mass of specimen in the mold assembly, 0.005 kg (0.01 lb.)
 V_s = volume of specimen in mold m³ (ft³)

Laboratory maximum dry density fine aggregate portion

$$\rho_d = \left(\frac{\rho_w}{w + 100} \right) \times 100 \quad \text{or} \quad \rho_d = \frac{\rho_w}{\left(\frac{w}{100} \right) + 1}$$

Where:

- ρ_d = dry density, kg/m³ (lb/ft³)
 w = moisture content, as a percentage (FOP for AASHTO T 255)

Laboratory maximum dry density of coarse aggregate portion

$$\rho_d = \left(\frac{M_s}{V_s} \right) \times 100$$

Where:

ρ_d	=	dry density, kg/m ³ (lb/ft ³)
M_s	=	mass of specimen in the mold assembly, 0.005 kg (0.01 lb.)
V_s	=	volume of specimen in mold m ³ (ft ³)

Example**Example for small mold fine aggregate portion**

Wet mass, M_w	=	6.470 kg (14.26 lb)
Moisture content, w	=	11.3%
Height of mold, h_m	=	203.7 mm (8.02 in.)
Inside diameter of mold, d	=	153.4 mm (6.04 in.)
Measurement from top of mold to follower, D	=	44.5 mm (1.75 in.)
Thickness of the follower, T	=	3.6 mm (0.14 in.)
Mass of specimen and mold assembly, M_{ms}	=	6.400 kg (14.11 lb)
Mass of mold assembly, M_m	=	0.280 kg (0.62 lb)

Height of fine aggregate portion in mold

$$h_s = h_m - D - T$$

$$h_s = 203.7 \text{ mm} - 44.5 \text{ mm} - 3.6 \text{ mm} = 155.6 \text{ mm}$$

$$h_s = 8.02 \text{ in.} - 1.75 \text{ in.} - 0.14 \text{ in.} = 6.13 \text{ in.}$$

Volume of the fine aggregate in the mold

$$V_s = \frac{h_s \times \pi \times \left(\frac{d}{2}\right)^2}{1e^9 \text{ mm}^3 / \text{m}^3 \text{ or } 1728 \text{ in}^3 / \text{ft}^3}$$

$$V_s = \frac{155.6 \text{ mm} \times \pi \times \left(\frac{153.4 \text{ mm}}{2}\right)^2}{1,000,000,000 \text{ mm}^3 / \text{m}^3} = 0.002876 \text{ m}^3$$

Or

$$V_s = \frac{6.13 \text{ in.} \times \pi \times \left(\frac{6.04 \text{ in.}}{2}\right)^2}{1728 \text{ in}^3 / \text{ft}^3} = 0.1016 \text{ ft}^3$$

Mass of fine aggregate portion in the mold

$$M_s = M_{ms} - M_m$$

$$M_s = 6.400 \text{ kg} - 0.280 \text{ kg} = 6.119 \text{ kg}$$

$$M_s = 14.11 \text{ lb} - 0.62 \text{ lb} = 13.49 \text{ lb}$$

Wet density of fine aggregate portion

$$\rho_w = \frac{M_s}{V_s}$$

$$\rho_w = \frac{6.119 \text{ kg}}{0.002876 \text{ m}^3} = 2128 \text{ kg/m}^3$$

$$\rho_w = \frac{13.49 \text{ lb}}{0.1016 \text{ ft}^3} = 132.8 \text{ lb/ft}^3$$

Laboratory maximum dry density of the fine aggregate portion

$$\rho_d = \left(\frac{\rho_w}{w + 100} \right) \times 100 \quad \text{or} \quad \rho_d = \frac{\rho_w}{\left(\frac{w}{100} \right) + 1}$$

$$\rho_d = \left(\frac{2128 \text{ kg/m}^3}{11.3\% + 100} \right) \times 100 = 1912 \text{ kg/m}^3 \quad \rho_d = \left(\frac{132.8 \text{ lb/ft}^3}{11.3\% + 100} \right) \times 100 = 119.3 \text{ lb/ft}^3$$

Or

$$\rho_d = \left(\frac{2128 \text{ kg/m}^3}{\frac{11.3\%}{100} + 1} \right) = 1912 \text{ kg/m}^3 \quad \rho_d = \left(\frac{132.8 \text{ lb/ft}^3}{\frac{11.3\%}{100} + 1} \right) = 119.3 \text{ lb/ft}^3$$

Example for small mold coarse aggregate portion (Procedure 1)

Calculations will be the same for Procedure 2

Height of mold assembly, h_m	=	203.7 mm (8.02 in.)
Inside diameter of mold, d	=	153.4 mm (6.04 in.)
Measurement from top of mold assembly to follower, D	=	42.4 mm (1.67 in.)
Thickness of the follower, T	=	3.6 mm (0.14 in.)
Mass of coarse aggregate in the mold assembly, M_s	=	4.985 kg (10.99 lb)

Height of coarse aggregate portion in mold

$$h_s = h_m - D - T$$

$$h_s = 203.7 \text{ mm} - 42.4 \text{ mm} - 3.6 \text{ mm} = 157.7 \text{ mm}$$

$$h_s = 8.02 \text{ in.} - 1.67 \text{ in.} - 0.14 \text{ in.} = 6.21 \text{ in.}$$

Volume of the coarse aggregate portion in the mold

$$V_s = \frac{h_s \times \pi \times \left(\frac{d}{2}\right)^2}{1e^9 \text{ mm}^3 / \text{m}^3 \text{ or } 1728 \text{ in}^3 / \text{ft}^3}$$

$$V_s = \frac{157.7 \text{ mm} \times \pi \times \left(\frac{153.4 \text{ mm}}{2}\right)^2}{1,000,000,000 \text{ mm}^3 / \text{m}^3} = 0.002915 \text{ m}^3$$

$$V_s = \frac{6.21 \text{ in.} \times \pi \times \left(\frac{6.04 \text{ in.}}{2}\right)^2}{1728 \text{ in}^3 / \text{ft}^3} = 0.1030 \text{ ft}^3$$

Laboratory maximum dry density of coarse aggregate portion

$$\rho_d = \left(\frac{M_s}{V_s} \right) \times 100$$

$$\rho_d = \left(\frac{4.985 \text{ kg}}{0.002915 \text{ m}^3} \right) \times 100 = 1710 \text{ kg/m}^3$$

$$\rho_d = \left(\frac{10.99 \text{ lb}}{0.1030 \text{ ft}^3} \right) \times 100 = 106.7 \text{ lb/ft}^3$$

Theoretical Maximum Density Curve Development

Enter the following data into an approved spreadsheet to develop the maximum density chart and maximum density curve.

- Laboratory maximum dry density, ρ_d , of the coarse aggregate portion to the nearest 1 kg/m^3 (0.1 lb/ft^3)
- Laboratory maximum dry density, $\bar{\rho}_d$, of the fine aggregate portion to the nearest 1 kg/m^3 (0.1 lb/ft^3)
- Optimum moisture content to the nearest 0.1 percent if the FOP for AASTHO T 99/T 180, T 99 Method A was used for the fine portion.
- Coarse aggregate apparent specific gravity, G_{sa} , to the nearest 0.001
- Fine aggregate portion apparent specific gravity, G_{sa} , to the nearest 0.001

Example

Theoretical Maximum Dry Density Chart

Density Curves				Density Curves			
Pass #4	Maximum	Pass #4	Maximum	Pass #4	Maximum	Pass #4	Maximum
0.0	104.8	31.0	133.7	62.0	134.6	82.0	129.6
1.0	105.6	32.0	134.5	63.0	134.3	83.0	129.4
2.0	106.4	33.0	135.2	64.0	134.0	84.0	129.3
3.0	107.1	34.0	135.8	65.0	133.6	85.0	129.1
4.0	107.9	35.0	136.4	66.0	133.3	86.0	128.9
5.0	108.7	36.0	137.0	67.0	133.1	87.0	128.8
6.0	109.5	37.0	137.5	68.0	132.8	88.0	128.6
7.0	110.3	38.0	137.9	69.0	132.5	89.0	128.4
8.0	111.1	39.0	138.3	70.0	132.2	90.0	128.3
9.0	112.0	40.0	138.6	71.0	132.0	91.0	128.1
10.0	112.8	41.0	138.9	72.0	131.7	92.0	128.0
11.0	113.7	42.0	139.0	73.0	131.5	93.0	127.9
12.0	114.5	43.0	139.2	74.0	131.2	94.0	127.7
13.0	115.4	44.0	139.2	75.0	131.0	95.0	127.6
14.0	116.4	45.0	139.2	76.0	130.8	96.0	127.4
15.0	117.3	46.0	139.2	77.0	130.6	97.0	127.3
16.0	118.2	47.0	139.1	78.0	130.4	98.0	127.2
17.0	119.2	48.0	139.0	79.0	130.2	99.0	127.0
18.0	120.2	49.0	138.8	80.0	130.0	100.0	126.9
19.0	121.3	50.0	138.6	81.0	129.8		
20.0	122.3	51.0	138.3				
21.0	123.4	52.0	138.1				
22.0	124.5	53.0	137.8				
23.0	125.6	54.0	137.5				
24.0	126.8	55.0	137.1				
25.0	127.9	56.0	136.8				
26.0	129.0	57.0	136.4				
27.0	130.0	58.0	136.0				
28.0	131.0	59.0	135.7				
29.0	132.0	60.0	135.3				
30.0	132.8	61.0	135.0				

Control Points for Density Curves		
Pass #4	Maximum	Loose
0.0	104.8	87.6
20.5	122.8	99.6
27.4	130.4	103.8
42.5	139.1	105.4
61.1	134.9	96.7
100.0	126.9	81.9

Theoretical Maximum Dry Density Curve

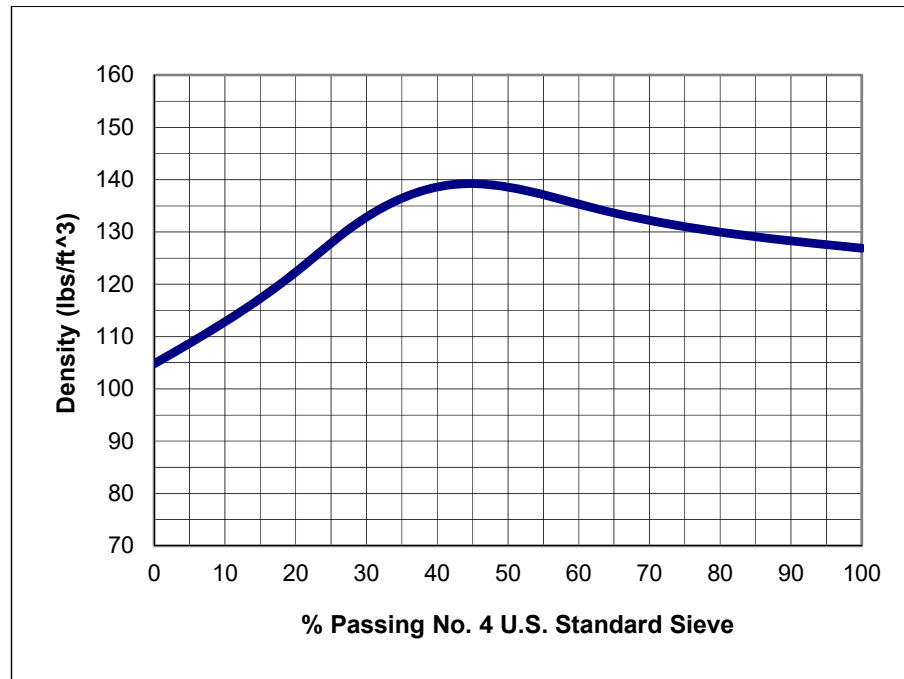

Report

- Results on standard agency forms
- Sample ID
- Laboratory maximum dry density of the coarse aggregate portion to the nearest 1 kg/m³ (0.1 lb/ft³)
- Laboratory maximum dry density of the fine aggregate portion to the nearest 1 kg/m³ (0.1 lb/ft³)
- Optimum moisture content to the nearest 0.1 percent (when using the FOP for AASTHO T 99/T 180, T 99 Method A for the fine aggregate portion)
- Coarse aggregate apparent specific gravity (G_{sa}) to the nearest 0.001
- Fine aggregate apparent specific gravity (G_{sa}) to the nearest 0.001
- Theoretical maximum dry density chart
- Theoretical maximum dry density curve

ANNEX A STANDARDIZATION OF THE MOLD ASSEMBLY

(Mandatory Information)

Apparatus

- Calipers having a range sufficient to measure the diameter of the measure being checked and readable to at least 0.1 mm (0.01 in.)
- Inside diameter caliper, 300 mm (12 in.) range
- Straight edge at least 25 mm (1 in.) larger than the mold
- Ruler readable to 0.1 mm (0.01 in.)

Procedure**Determine the height of the mold (h_m)**

1. Place the straight edge across the top of the mold with mold base.
2. Using the caliper measure from the bottom of the straight edge to the center mold with base to the nearest 0.1 mm (0.01 in.)
3. Turn the straight edge 90 degrees.
4. Repeat Step 2.
5. Average the two measurements.
6. Designate as h_m

Determine the thickness of the mold follower and spacers (T)

1. Place follower and spacers inside the mold with mold base.
2. Place the straight edge across the top of the mold.
3. Using the caliper measure from the bottom of the straight edge to the center of the top of the follower to the nearest 0.1 mm (0.01 in.).
4. Turn the straight edge 90 degrees.
5. Repeat Step 3.
6. Average the two measurements.
7. Subtract the average measurement from h_m
8. Designate as T.

Determine the inside diameter of the mold (d)

1. Using the caliper measure the inside diameter of the mold to the nearest 0.1 mm (0.01 in.).
2. Turn the mold 90 degrees.
3. Repeat Step 1.
4. Average the two measurements.
5. Designate as d.

ANNEX B APPARENT SPECIFIC GRAVITY (G_{sb}) DETERMINATION

(Mandatory Information)

This procedure covers the determination of apparent specific of coarse and fine aggregate by means of a pycnometer. When the soil is composed of material both larger and smaller than the 4.75 mm (No. 4) sieve, the sample is separated on the 4.75 mm (No. 4) sieve.

Apparatus

- Pycnometer: A flask or other suitable container in which the volume can be reproduced within ± 0.1 ml. The volume of the flask shall be at least 50 percent greater than required for the test sample.
- Pycnometer / volumetric flask cover: A glass plate or a metal or plastic cover with a vented opening
- Balance: A balance of sufficient capacity, readable to 0.1 g. Meeting AASHTO M 231, Class G2.
- Oven: Capable of maintaining a temperature of $110 \pm 5^{\circ}\text{C}$ ($230 \pm 9^{\circ}\text{F}$) for drying the specimens to a constant mass.
- Vacuum lid: A transparent lid with a suitable vacuum connection, with a vacuum opening to be covered with a fine wire mesh
- Vacuum: Capable of evacuating air from the container to a partial vacuum of 13.33 kPa (100 mmHg) or less absolute pressure
- Manometer or vacuum gauge: Capable of measuring the vacuum being applied at the source of the vacuum
- Water bath: A constant-temperature water bath (optional)
- Thermometers: Thermometric devices accurate to 0.5°C (1°F)
- Bleeder valve to adjust vacuum
- Timer

Sample Preparation

1. Sample and reduce the aggregate in accordance with the FOPs for AASHTO R 90 and R 76.
2. Dry the sample sufficiently to obtain a clean separation of fine and coarse material in the sieving operation.
3. Sieve the sample in accordance with the FOP for AASHTO T 27/ T 11 over the 4.75 mm (No. 4) sieve.

Coarse test sample

- a. Split or quarter approximately 1000 g of material from the portion retained on the 4.75 mm (No. 4) sieve.
- b. Dry to constant mass according to the FOP for AASHTO T 255 at $110 \pm 5^{\circ}\text{C}$ ($230 \pm 9^{\circ}\text{F}$).
- c. Cool to room temperature.

Fine test sample

- a. Split or quarter approximately 500 g of material from the portion passing the 4.75 mm (No. 4) sieve.
- b. Dry to constant mass according to the FOP for AASHTO T 255/T 265 at $110 \pm 5^{\circ}\text{C}$ ($230 \pm 9^{\circ}\text{F}$).
- c. Cool to room temperature.

Procedure

The procedure is performed on fine and coarse aggregate separately.

1. Determine and record the mass of the dry test sample. Designate as A.
2. Place the test sample in the pycnometer.
3. Add water at approximately 20°C (68°F) until the pycnometer is about $\frac{3}{4}$ full.
4. Connect the pycnometer to the vacuum system.
5. Apply partial vacuum, 30 mmHg or less absolute pressure, for 20 ± 1 min.
6. Agitate the pycnometer and contents, either continuously by mechanical device or manually by vigorous shaking, at 2-minute intervals. This agitation facilitates the removal of entrapped air.
7. Release vacuum and disconnect the hoses.
8. Fill the pycnometer with water without reintroducing air. Water temperature should be maintained as close to $20 \pm 0.5^{\circ}\text{C}$ ($68 \pm 1^{\circ}\text{F}$) as possible throughout the procedure.

Note 1: It may be necessary to place the pycnometer in a water bath for 10 minutes after the release of vacuum to stabilize at $20 \pm 0.5^{\circ}\text{C}$ ($68 \pm 1^{\circ}\text{F}$).

- a. Metal pycnometer (coarse test sample only) – Fill the pycnometer with $20 \pm 0.5^{\circ}\text{C}$ ($68 \pm 1^{\circ}\text{F}$) water according to manufacturer's instructions and dry the outside.
 - b. Glass pycnometer (fine or coarse test samples) – Completely fill the pycnometer with $20 \pm 0.5^{\circ}\text{C}$ ($68 \pm 1^{\circ}\text{F}$) water, slide the calibrated glass plate over the mouth of the pycnometer making sure there are no air bubbles trapped under the plate. Dry the outside.
9. Determine and record the mass of the pycnometer, sample, and water. Designate as C.

Calculation

Calculate the G_{sa} to three decimal places as follows:

$$G_{sa} = \frac{A}{A + B - C}$$

Where:

- A = Mass of dry sample in air, g
- B = Mass of pycnometer filled with water at 20°C (68°F), g, determined during the Standardization of Pycnometer procedure
- C = Mass of pycnometer, water, and the test sample at to 20 ±0.5°C (68 ±1°F), g

Coarse example:

$$G_{sa} = \frac{2200.3 \text{ g}}{2200.3 \text{ g} + 7502.5 \text{ g} - 8812.0 \text{ g}} = 2.470$$

Given:

- A = 2200.3 g
- B = 7502.5 g
- C = 8812.0 g

Report

- Report on standard agency forms.
- Report apparent specific gravities, G_{sa} , to the nearest 0.001

Standardization of Pycnometer

The pycnometer shall be standardized periodically in conformance with procedures established by the agency.

1. Fill the pycnometer with water at approximately 20°C (68°F).
2. Place the metal or plastic cover, or a glass plate on the pycnometer and eliminate all air.

Note B1: When using a metal pycnometer and cover, place the cover on the pycnometer and push down slowly, forcing excess water out of the hole in the center of the cover. Use care when filling the pycnometer to avoid reintroducing air into the water.

3. Stabilize the pycnometer at $20 \pm 0.5^\circ\text{C}$ ($68 \pm 1^\circ\text{F}$) for 10 ± 1 min.
4. Towel dry the outside of the pycnometer and cover.
5. Determine and record the mass of the pycnometer, water, and lid.
6. Repeat Steps 2 through 5 two more times for a total of three determinations.
7. If the variation of the three masses is within 0.3 g, average the three masses. Designate as “B.”
8. If the variation of the masses is greater than 0.3 g, take corrective action and perform the “Standardization of Pycnometer” again.

Performance Exam Checklist

Laboratory Theoretical Maximum Dry Density of Granular Soil and Soil/Aggregate

WAQTC TM 15

Participant Name _____ Exam Date _____

Record the symbols "P" for passing or "F" for failing on each step of the checklist.

Procedure Element	Trial 1	Trial 2
1. The tester has a copy of the current procedure on hand?	_____	_____
2. All equipment is functioning according to the test procedure, and if required has the current calibration/standardization/check and maintenance tags present?	_____	_____
Sample Preparation		
3. A minimum of 180 kg. (400 lbs.) representative sample material obtained according to FOP for AASHTO R 90?	_____	_____
4. Representative sample reduced according to FOP for AASHTO R 76 to yield the sample sizes for testing?	_____	_____
5. If damp, sample dried at a temperature not exceeding 60°C (140°F)?	_____	_____
6. Material retained on the 75 mm (3 in.) sieve removed?	_____	_____
7. Coarse and fine aggregate portions separated through the 4.75 mm (No. 4) sieve?	_____	_____
Fine Aggregate Portion		
8. Proper test method selected based on Table 1?	_____	_____
9. Mass of clean dry small mold determined to the nearest 5 g (0.01 lb.)?	_____	_____
10. Enough water added to saturate sample and mixed until homogenous?	_____	_____
11. Each lift consolidated with 25 strokes of tamping rod and 25 blows of manually operated rammer?	_____	_____
12. Top lift finished as level as possible?	_____	_____
13. Mold cap placed and spacers utilized so the hammers strike near the center of mass in the mold?	_____	_____
14. Initial seating load of approximately 100 lbf applied?	_____	_____
15. Compaction begun and load application rate per Table 3 followed?	_____	_____
16. Based on the determination of apparent moisture, compaction cycle repeated four additional times or a new sample is prepared and test restarted from Step 1.?	_____	_____
17. Height of compacted specimen determined and recorded?	_____	_____
18. Mass of specimen determined and recorded?	_____	_____
19. Moisture content determined and recorded?	_____	_____

Procedure Element	Trial 1	Trial 2
20. Dry density determined?	_____	_____
21. Coarse Aggregate Portion	_____	_____
22. Proper test method selected based on Table 2?	_____	_____
Procedure 1		
23. Mass of clean dry small mold determined to the nearest 5 g (0.01 lb.)?	_____	_____
24. Mass of coarse aggregate portion determined to the nearest 5 g (0.01 lb.)?	_____	_____
25. Coarse aggregate mass multiplied by 0.025 to determine mass of water to be added?	_____	_____
26. Water and coarse aggregate mixed thoroughly?	_____	_____
27. Each lift tamped lightly with manually operated rammer?	_____	_____
28. Mold cap placed and spacers utilized so the hammers strike near the center of mass in the mold?	_____	_____
29. Initial seating load of approximately 100 lbf applied?	_____	_____
30. Compaction begun and load application rate per Table 3 followed?	_____	_____
31. Compaction cycle repeated four additional times?	_____	_____
32. Height of compacted specimen determined and recorded?	_____	_____
33. Dry density determined?	_____	_____
Procedure 2		
34. Mass of clean dry small mold determined to the nearest 5 g (0.01 lb.)?	_____	_____
35. Mass of coarse aggregate portion determined to the nearest 5 g (0.01 lb.)?	_____	_____
36. Approximately one fifth of the sample place in mold?	_____	_____
37. Lift tamped lightly with manually operated rammer to consolidate and level?	_____	_____
38. Mold cap placed and spacers utilized so the hammers strike near the center of mass in the mold?	_____	_____
39. Initial seating load of approximately 100 lbf applied?	_____	_____
40. Compaction begun and load application rate per Table 3 followed?	_____	_____
41. Aggregate placement and compaction cycle repeated four additional times?	_____	_____
42. Height of compacted specimen determined and recorded?	_____	_____
43. Dry density determined?	_____	_____

Procedure Element	Trial 1	Trial 2
Apparent Specific Gravity of the Fine and Coarse Portions According to Annex B		
44. Appropriate amount of coarse and fine aggregate portions obtained, dried, and cooled?	_____	_____
45. Mass of dry test sample(s) determined and recorded?	_____	_____
46. Test sample(s) placed in pycnometer and 20°C (68°F) water added to about ¾ full?	_____	_____
47. Partial vacuum applied to pycnometer and contents for 20 ± 1 min. and agitated by mechanical device or manually?	_____	_____
48. Vacuum released and pycnometer filled with water without reintroducing air?	_____	_____
49. Water stabilized at 20 ±0.5°C (68 ±1°F), pycnometer cover positioned, and outside dried?	_____	_____
50. Mass of pycnometer, sample, and water determined and recorded?	_____	_____
51. Specific Gravity determined?	_____	_____

First Attempt: Pass Fail

Second Attempt: Pass Fail

Signature of Examiner _____ WAQTC #: _____

Comments:

WSDOT FOP for AASHTO T 22

Compressive Strength of Cylindrical Concrete Specimens

WSDOT has adopted the published AASHTO T 22 with errata's below.

AASHTO Test Methods cannot be included in Materials Manual due to copyright infringement.

WSDOT employees can access AASHTO and ASTM test methods in the following web address:

<http://wwwi.wsdot.wa.gov/MatsLab/BusinessOperations/ASTMLogin.htm>

Non-WSDOT employees can order AASHTO's Standard Specifications for Transportation Materials and Methods of Sampling and Testing, using the following web address: <https://store.transportation.org>

5. Significance and Use

5.2. *Include Note below.*

Note: Testing for determining compressive strength of cylinder specimens shall require a set of two specimens made from the same sample.

7. Specimens

6.3. *Step not recognized by WSDOT.*

6.4. *Determine specimen mass and length as described below.*

Remove any surface moisture with a towel and measure the mass of the specimen using a balance or scale that is accurate to within 0.3 percent of the mass being measured. Measure the length of the specimen to the nearest 1 mm (0.05 in.) at three locations spaced evenly around the circumference. Compute the average length and record to the nearest 1 mm (0.05 in.).

8. Procedure

8.3. *Include Note below.*

Note: The 28-day compressive break may be extended by up to 48 hours if the scheduled 28-day break falls on a Saturday, Sunday, or Holiday. The Regional Materials Engineer must authorize the time extension in writing.

10. Report

10.1. *Include Note below.*

Note: The report shall also include specimen mass and length as determined in 7.4..

Performance Exam Checklist

Compressive Strength of Cylindrical Concrete Specimens AASHTO T 22

Participant Name _____ Exam Date _____

Record the symbols "P" for passing or "F" for failing on each step of the checklist.

Procedure Element	Trial 1	Trial 2
1. The tester has a copy of the current procedure on hand?	_____	_____
2. All equipment is functioning according to the test procedure, and if required has the current calibration/standardization/check and maintenance tags present?	_____	_____
3. Specimens kept moist between removal from moist storage and testing?	_____	_____
4. Diameter of the cylinder recorded to the nearest 0.01 inch by averaging two diameters taken at about mid-height?	_____	_____
5. Specimen not tested if individual diameter readings differ more than 2 percent?	_____	_____
6. Ends of specimen checked for perpendicularity to the axis?	_____	_____
7. Specimen mass and length recorded?	_____	_____
8. Ends of specimen checked for plane?	_____	_____
9. If ends not plane, specimen sawed or ground to meet tolerance or capped in accordance to either AASHTO T 231 or ASTM C1231? (Refer to AASHTO T 231 or ASTM C1231 procedure and checklist if used)	_____	_____
10. Bearing faces wiped clean?	_____	_____
11. Load indicator set to zero?	_____	_____
12. Spherical seated block parallel to top of specimen prior to applying load?	_____	_____
13. If using Unbonded Caps, alignment of specimen checked after application of load but before reaching 10 percent of anticipated load strength?	_____	_____
14. Load applied continuously and without shock?	_____	_____
15. The designated load rate maintained at least during the latter half of anticipated load strength?	_____	_____
16. No adjustment to load rate as ultimate load is being approached?	_____	_____
17. Compressive load continued until tester is certain ultimate capacity has been attained?	_____	_____
18. Maximum load and type of fracture recorded?	_____	_____
19. Specimens broken within permissible time tolerances?	_____	_____
20. All calculations performed correctly?	_____	_____

First Attempt: Pass Fail Second Attempt: Pass Fail

Signature of Examiner _____

Comments:

WSDOT Errata to FOP for AASHTO T 27_T 11

Sieve Analysis of Fine and Coarse Aggregates

WAQTC FOP for AASHTO T 27_T 11 has been adopted by WSDOT with the following changes:

Procedure Method C – *Method not recognized by WSDOT.*

Sample Preparation

Table 1 Test Sample Sizes for Aggregate Gradation Test – *Shall conform to the following table and nominal maximum size definition.*

Nominal Maximum Size*in (mm)		Minimum Dry Mass lb (kg)	
US No. 4	(4.75)	1	(0.5)
¼	(6.3)	2	(1)
⅜	(9.5)	2	(1)
½	(12.5)	5	(2)
⅝	(16.0)	5	(2)
¾	(19.0)	7	(3)
1	(25.0)	13	(6)
1¼	(31.5)	17	(7.5)
1½	(37.5)	20	(9)
2	(50)	22	(10)
2½	(63)	27	(12)
3	(75)	33	(15)
3½	(90)	44	(20)

*For Aggregate, the nominal maximum size sieve is the largest standard sieve opening listed in the applicable specification upon which more than 1-percent of the material by weight is permitted to be retained. For concrete aggregate, the nominal maximum size sieve is the smallest standard sieve opening through which the entire amount of aggregate is permitted to pass.

Procedure Method A

Replace step 1. and 11. with below:

1. Dry the sample to constant mass according to the FOP for AASHTO T 255. Cool to room temperature.
11. Dry the washed sample to constant mass according to the FOP for AASHTO T 255. Cool to room temperature.

Procedure Method B

Replace step 1. and 11. with below:

1. Dry the sample to constant mass according to the FOP for AASHTO T 255. Cool to room temperature.
11. Dry the washed sample to constant mass according to the FOP for AASHTO T 255. Cool to room temperature.

**SIEVE ANALYSIS OF FINE AND COARSE AGGREGATES
FOP FOR AASHTO T 27
MATERIALS FINER THAN 75 µM (NO. 200) SIEVE IN MINERAL AGGREGATE
BY WASHING
FOP FOR AASHTO T 11**

Scope

A sieve analysis, or ‘gradation,’ measures distribution of aggregate particle sizes within a given sample.

Accurate determination of the amount of material smaller than 75 µm (No. 200) cannot be made using just AASHTO T 27. If quantifying this material is required, use AASHTO T 11 in conjunction with AASHTO T 27.

This FOP covers sieve analysis in accordance with AASHTO T 27-22 and materials finer than 75 µm (No. 200) in accordance with AASHTO T 11-22 performed in conjunction with AASHTO T 27. The procedure includes three methods: A, B, and C.

Apparatus

- Balance or scale: Capacity sufficient for the masses shown in Table 1, accurate to 0.1 percent of the sample mass or readable to 0.1 g, and meeting the requirements of AASHTO M 231
- Sieves: Meeting the requirements of ASTM E11
- Mechanical sieve shaker: Meeting the requirements of AASHTO T 27
- Suitable drying equipment (refer to FOP for AASHTO T 255)
- Containers and utensils: A pan or vessel of sufficient size to contain the sample covered with water and permit vigorous agitation without loss of material or water
- Optional
 - Mechanical washing device
 - Mallet: With a rubber or rawhide head having a mass of 0.57 ± 0.23 kg (1.25 ± 0.5 lb)

Sample Sieving

- In all procedures, the sample is shaken in nested sieves. Sieves are selected to furnish information required by specification. Intermediate sieves are added for additional information or to avoid overloading sieves, or both.
- The sieves are nested in order of increasing size from the bottom to the top, and the sample, or a portion of the sample, is placed on the top sieve.
- The loaded sieves are shaken in a mechanical shaker for approximately 10 minutes, refer to Annex A, *Time Evaluation*.

- Care must be taken so that sieves are not overloaded, refer to Annex B, *Overload Determination*. The sample may be sieved in increments and the mass retained for each sieve added together from each sample increment to avoid overloading sieves.

Sample Preparation

Obtain samples according to the FOP for AASHTO R 90 and reduce to sample size, shown in Table 1, according to the FOP for AASHTO R 76.

TABLE 1
Sample Sizes for Aggregate Gradation Test

Nominal Maximum Size* mm (in.)	Minimum Dry Mass g (lb)
125 (5)	300,000 (660)
100 (4)	150,000 (330)
90 (3 1/2)	100,000 (220)
75 (3)	60,000 (130)
63 (2 1/2)	35,000 (77)
50 (2)	20,000 (44)
37.5 (1 1/2)	15,000 (33)
25.0 (1)	10,000 (22)
19.0 (3/4)	5000 (11)
12.5 (1/2)	2000 (4)
9.5 (3/8)	1000 (2)
6.3 (1/4)	1000 (2)
4.75 (No. 4)	500 (1)

*Nominal maximum size: One sieve larger than the first sieve to retain more than 10 percent of the material using an agency specified set of sieves based on cumulative percent retained. Where large gaps between specification sieves exist, intermediate sieve(s) may be inserted to determine nominal maximum size.

Sample sizes in Table 1 are standard for aggregate sieve analysis, due to equipment restraints samples may need to be divided into several “subsamples.” For example, a gradation that requires 100 kg (220 lbs.) of material would not fit into a large tray shaker all at once.

Some agencies permit reduced sample sizes if it is proven that doing so is not detrimental to the test results. Some agencies require larger sample sizes. Check agency guidelines for required or permitted sample sizes.

Selection of Procedure

Agencies may specify which method to perform. If a method is not specified, perform Method A.

Overview

Method A

- Determine original dry mass of the sample
- Wash over a 75 μ m (No. 200) sieve
- Determine dry mass of washed sample
- Sieve washed sample
- Calculate and report percent retained and passing each sieve

Method B

- Determine original dry mass of the sample
- Wash over a 75 μ m (No. 200) sieve
- Determine dry mass of washed sample
- Sieve sample through coarse sieves, 4.75 mm (No. 4) sieves and larger
- Determine mass of fine material, minus 4.75 mm (No. 4)
- Reduce fine material
- Determine mass of reduced portion
- Sieve reduced portion
- Calculate and report percent retained and passing each sieve

Method C

- Determine original dry mass of the sample
- Sieve sample through coarse sieves, 4.75 mm (No. 4) sieves and larger
- Determine mass of fine material, minus 4.75 mm (No. 4)
- Reduce fine material
- Determine mass of reduced portion
- Wash reduced portion over a 75 μ m (No. 200) sieve
- Determine dry mass of washed reduced portion
- Sieve washed reduced portion
- Calculate and report percent retained and passing each sieve

Procedure Method A

1. Dry the sample to constant mass $110 \pm 5^\circ\text{C}$ ($230 \pm 9^\circ\text{F}$) according to the FOP for AASHTO T 255. Cool to room temperature.
2. Determine and record the original dry mass of the sample to the nearest 0.1 percent or 0.1 g. Designate this mass as *M*.

When the specification does not require the amount of material finer than $75 \mu\text{m}$ (No. 200) be determined by washing, skip to Step 11.

3. Nest a sieve, such as a 2.0 mm (No. 10), above the $75 \mu\text{m}$ (No. 200) sieve.
4. Place the sample in a container and cover with water.

Note 1: A detergent, dispersing agent, or other wetting solution may be added to the water to assure a thorough separation of the material finer than the $75 \mu\text{m}$ (No. 200) sieve from the coarser particles. There should be enough wetting agent to produce a small amount of suds when the sample is agitated. Excessive suds may overflow the sieves and carry material away with them.

5. Agitate vigorously to ensure complete separation of the material finer than $75 \mu\text{m}$ (No. 200) from coarser particles and bring the fine material into suspension above the coarser material. Avoid degradation of the sample when using a mechanical washing device.

Note 2: Washing longer than 10 minutes in a mechanical washer has been shown to cause significant amounts of degradation depending upon aggregate type.

6. Immediately pour the wash water containing the suspended material over the nested sieves; be careful not to pour out the coarser particles or over fill the $75 \mu\text{m}$ (No. 200) sieve.
7. Add water to cover material remaining in the container, agitate, and repeat Step 5. Continue until the wash water is reasonably clear.
8. Remove the upper sieve and return material retained to the washed sample.
9. Rinse the material retained on the $75 \mu\text{m}$ (No. 200) sieve until water passing through the sieve is reasonably clear and detergent or dispersing agent is removed, if used.
10. Return all material retained on the $75 \mu\text{m}$ (No. 200) sieve to the container by rinsing into the washed sample.

Note 3: Excess water may be carefully removed with a bulb syringe; the removed water must be discharged back over the $75 \mu\text{m}$ (No. 200) sieve to prevent loss of fines.

11. Dry the washed sample to constant mass at $110 \pm 5^\circ\text{C}$ ($230 \pm 9^\circ\text{F}$) according to the FOP for AASHTO T 255. Cool to room temperature.
12. Determine and record the dry mass of the sample.
13. Select sieves required by the specification and those necessary to avoid overloading as described in Annex B. With a pan on bottom, nest the sieves increasing in size starting with the $75 \mu\text{m}$ (No. 200).
14. Place the sample, or a portion of the sample, on the top sieve. Sieves may already be in the mechanical shaker, if not place sieves in mechanical shaker and shake for the

minimum time determined to provide complete separation for the sieve shaker being used (approximately 10 minutes, the time determined by Annex A).

Note 4: Excessive shaking (more than 10 minutes) may result in degradation of the sample.

15. Determine and record the individual or cumulative mass retained for each sieve and in the pan. Ensure that all material trapped in full openings of the sieve are removed and included in the mass retained.

Note 5: For sieves 4.75 mm (No. 4) and larger, check material trapped in less than a full opening by sieving over a full opening. Use coarse wire brushes to clean the 600 μm (No. 30) and larger sieves, and soft bristle brushes for smaller sieves.

Note 6: In the case of coarse / fine aggregate mixtures, distribute the minus 4.75 mm (No. 4) among two or more sets of sieves to prevent overloading of individual sieves.

16. Perform the *Check Sum* calculation – Verify the *total mass after sieving* compared to the *dry mass before sieving* is not more than 0.3 percent. The *dry mass before sieving* is the dry mass after wash or the original dry mass (M) if performing the sieve analysis without washing. Do not use test results for acceptance if the *Check Sum* result is more than 0.3 percent.

17. Calculate the total percentages passing, and the individual or cumulative percentages retained to the nearest 0.1 percent by dividing the individual sieve masses or cumulative sieve masses by the original dry mass (M) of the sample.

18. Report total percent passing to 1 percent except report the 75 μm (No. 200) sieve to 0.1 percent.

Method A Calculations

Check Sum

$$\text{Check Sum} = \frac{\text{dry mass before sieving} - \text{total mass after sieving}}{\text{dry mass before sieving}} \times 100$$

Percent Retained

$$\text{IPR} = \frac{\text{IMR}}{M} \times 100 \quad \text{or} \quad \text{CPR} = \frac{\text{CMR}}{M} \times 100$$

Where:

IPR	=	Individual Percent Retained
CPR	=	Cumulative Percent Retained
M	=	Original dry mass of the sample
IMR	=	Individual Mass Retained
CMR	=	Cumulative Mass Retained

AGGREGATE

WAQTC

FOP AASHTO T 27 / T 11 (22)

Percent Passing (PP)

$$PP = PPP - IPR \quad \text{or} \quad PP = 100 - CPR$$

Where:

PP = Percent Passing

PPP = Previous Percent Passing

Method A Example Individual Mass RetainedOriginal dry mass of the sample (*M*): 5168.7 g

Dry mass of the sample after washing: 4911.3 g

Total mass after sieving equals

Sum of Individual Masses Retained (IMR),
including minus 75 μm (No. 200) in the pan: 4905.9 g

Amount of 75μm (No. 200) minus washed out (5168.7 g – 4911.3 g): 257.4 g

Check Sum

$$\text{Check Sum} = \frac{4911.3 \text{ g} - 4905.9 \text{ g}}{4911.3 \text{ g}} \times 100 = 0.1\%$$

The result is not more than 0.3 percent therefore the results can be used for acceptance purposes.

Individual Percent Retained (IPR) for 9.5 mm (3/8 in.) sieve:

$$IPR = \frac{619.2 \text{ g}}{5168.7 \text{ g}} \times 100 = 12.0\%$$

Percent Passing (PP) 9.5 mm (3/8 in.) sieve:

$$PP = 86.0\% - 12.0\% = 74.0\%$$

Reported Percent Passing = 74%

**Method A Individual
Gradation on All Sieves**

Sieve Size mm (in.)	Individual Mass Retained g (IMR)	Determine IPR by dividing IMR by <i>M</i> and multiplying by 100	Individual Percent Retained (IPR)	Determine PP by subtracting IPR from previous PP	Percent Passing (PP)	Reported Percent Passing*
19.0 (3/4)	0		0		100.0	100
12.5 (1/2)	724.7	$\frac{724.7}{5168.7} \times 100 =$	14.0	$100.0 - 14.0 =$	86.0	86
9.5 (3/8)	619.2	$\frac{619.2}{5168.7} \times 100 =$	12.0	$86.0 - 12.0 =$	74.0	74
4.75 (No. 4)	1189.8	$\frac{1189.8}{5168.7} \times 100 =$	23.0	$74.0 - 23.0 =$	51.0	51
2.36 (No. 8)	877.6	$\frac{877.6}{5168.7} \times 100 =$	17.0	$51.0 - 17.0 =$	34.0	34
1.18 (No. 16)	574.8	$\frac{574.8}{5168.7} \times 100 =$	11.1	$34.0 - 11.1 =$	22.9	23
0.600 (No. 30)	329.8	$\frac{329.8}{5168.7} \times 100 =$	6.4	$22.9 - 6.4 =$	16.5	17
0.300 (No. 50)	228.5	$\frac{228.5}{5168.7} \times 100 =$	4.4	$16.5 - 4.4 =$	12.1	12
0.150 (No. 100)	205.7	$\frac{205.7}{5168.7} \times 100 =$	4.0	$12.1 - 4.0 =$	8.1	8
0.075 (No. 200)	135.4	$\frac{135.7}{5168.7} \times 100 =$	2.6	$8.1 - 2.6 =$	5.5	5.5
minus 0.075 (No. 200) in the pan	20.4					
Total mass after sieving = sum of sieves + mass in the pan = 4905.9 g						
Original dry mass of the sample (<i>M</i>): 5168.7g						

* Report total percent passing to 1 percent except report the 75 μ m (No. 200) sieve to 0.1 percent.

AGGREGATE

WAQTC

FOP AASHTO T 27 / T 11 (22)

Method A Example Cumulative Mass Retained

Original dry mass of the sample (<i>M</i>):	5168.7 g
Dry mass of the sample after washing:	4911.3 g
Total mass after sieving equals Final Cumulative Mass Retained (FCMR) (includes minus 75 μm (No. 200) from the pan):	4905.9 g
Amount of 75 μm (No. 200) minus washed out (5168.7 g – 4911.3 g):	257.4 g

Check Sum

$$\text{Check Sum} = \frac{4911.3 \text{ g} - 4905.9 \text{ g}}{4911.3 \text{ g}} \times 100 = 0.1\%$$

The result is not more than 0.3 percent therefore the results can be used for acceptance purposes.

Cumulative Percent Retained (CPR) for 9.5 mm (3/8 in.) sieve:

$$\text{CPR} = \frac{1343.9 \text{ g}}{5168.7 \text{ g}} \times 100 = 26.0\%$$

Percent Passing (PP) 9.5 mm (3/8 in.) sieve:

$$\text{PP} = 100.0\% - 26.0\% = 74.0\%$$

Reported Percent Passing = 74%

AGGREGATE

WAQTC

FOP AASHTO T 27 / T 11 (22)

**Method A Cumulative
Gradation on All Sieves**

Sieve Size mm (in.)	Cumulative Mass Retained g (CMR)	Determine CPR by dividing CMR by M and multiplying by 100	Cumulative Percent Retained (CPR)	Determine PP by subtracting CPR from 100.0	Percent Passing (PP)	Reported Percent Passing*
19.0 (3/4)	0		0.0		100.0	100
12.5 (1/2)	724.7	$\frac{724.7}{5168.7} \times 100 =$	14.0	$100.0 - 14.0 =$	86.0	86
9.5 (3/8)	1343.9	$\frac{1343.9}{5168.7} \times 100 =$	26.0	$100.0 - 26.0 =$	74.0	74
4.75 (No. 4)	2533.7	$\frac{2533.7}{5168.7} \times 100 =$	49.0	$100.0 - 49.0 =$	51.0	51
2.36 (No. 8)	3411.3	$\frac{3411.3}{5168.7} \times 100 =$	66.0	$100.0 - 66.0 =$	34.0	34
1.18 (No. 16)	3986.1	$\frac{3986.1}{5168.7} \times 100 =$	77.1	$100.0 - 77.1 =$	22.9	23
0.600 (No. 30)	4315.9	$\frac{4315.9}{5168.7} \times 100 =$	83.5	$100.0 - 83.5 =$	16.5	17
0.300 (No. 50)	4544.4	$\frac{4544.4}{5168.7} \times 100 =$	87.9	$100.0 - 87.9 =$	12.1	12
0.150 (No. 100)	4750.1	$\frac{4750.1}{5168.7} \times 100 =$	91.9	$100.0 - 91.9 =$	8.1	8
0.075 (No. 200)	4885.5	$\frac{4885.5}{5168.7} \times 100 =$	94.5	$100.0 - 94.5 =$	5.5	5.5
FCMR	4905.9					
Total mass after sieving: 4905.9 g						
Original dry mass of the sample (M): 5168.7 g						

* Report total percent passing to 1 percent except report the 75 µm (No. 200) sieve to 0.1 percent.

Procedure Method B

1. Dry the sample to constant mass at $110 \pm 5^\circ\text{C}$ ($230 \pm 9^\circ\text{F}$) according to the FOP for AASHTO T 255. Cool to room temperature.
2. Determine and record the original dry mass of the sample to the nearest 0.1 percent or 0.1 g. Designate this mass as *M*.

When the specification does not require the amount of material finer than $75 \mu\text{m}$ (No. 200) be determined by washing, skip to Step 11.

3. Nest a protective sieve, such as a 2.0 mm (No. 10), above the $75 \mu\text{m}$ (No. 200) sieve.
4. Place the sample in a container and cover with water.

Note 1: A detergent, dispersing agent, or other wetting solution may be added to the water to assure a thorough separation of the material finer than the $75 \mu\text{m}$ (No. 200) sieve from the coarser particles. There should be enough wetting agent to produce a small amount of suds when the sample is agitated. Excessive suds may overflow the sieves and carry material away with them.

5. Agitate vigorously to ensure complete separation of the material finer than $75 \mu\text{m}$ (No. 200) from coarser particles and bring the fine material into suspension above the coarser material. Avoid degradation of the sample when using a mechanical washing device.

Note 2: Washing longer than 10 minutes in a mechanical washer has been shown to cause significant amounts of degradation depending upon aggregate type.

6. Immediately pour the wash water containing the suspended material over the nested sieves; be careful not to pour out the coarser particles or over fill the $75 \mu\text{m}$ (No. 200) sieve.
7. Add water to cover material remaining in the container, agitate, and repeat Step 5. Continue until the wash water is reasonably clear.
8. Remove the upper sieve and return material retained to the washed sample.
9. Rinse the material retained on the $75 \mu\text{m}$ (No. 200) sieve until water passing through the sieve is reasonably clear and detergent or dispersing agent is removed, if used.
10. Return all material retained on the $75 \mu\text{m}$ (No. 200) sieve to the container by rinsing into the washed sample.

Note 3: Excess water may be carefully removed with a bulb syringe; the removed water must be discharged back over the $75 \mu\text{m}$ (No. 200) sieve to prevent loss of fines.

11. Dry the washed sample to constant mass at $110 \pm 5^\circ\text{C}$ ($230 \pm 9^\circ\text{F}$) according to the FOP for AASHTO T 255. Cool to room temperature.
12. Determine and record the dry mass after wash.
13. Select sieves required by the specification and those necessary to avoid overloading as described in Annex B. With a pan on bottom, nest the sieves increasing in size starting with the 4.75 mm (No. 4).
14. Place the sample, or a portion of the sample, on the top sieve. Sieves may already be in the mechanical shaker, if not place the sieves in the mechanical shaker and shake for the

minimum time determined to provide complete separation for the sieve shaker being used (approximately 10 minutes, the time determined by Annex A).

Note 4: Excessive shaking (more than 10 minutes) may result in degradation of the sample.

15. Determine and record the individual or cumulative mass retained for each sieve. Ensure that all particles trapped in full openings of the sieve are removed and included in the mass retained.

Note 5: For sieves 4.75 mm (No. 4) and larger, check material trapped in less than a full opening by sieving over a full opening. Use coarse wire brushes to clean the 600 μm (No. 30) and larger sieves, and soft hair bristle for smaller sieves.

16. Determine and record the mass of the minus 4.75 mm (No. 4) material in the pan. Designate this mass as M_1 .
17. Perform the *Coarse Check Sum* calculation – Verify the *total mass after coarse sieving* compared to the *dry mass before sieving* to not more than 0.3 percent. The *dry mass before sieving* is the dry mass after wash or the original dry mass (M) if performing the sieve analysis without washing. Do not use test results for acceptance if the *Check Sum* result is more than 0.3 percent.
18. Reduce the minus 4.75 mm (No. 4) according to the FOP for AASHTO R 76 to produce a sample with a minimum mass of 500 g. Determine and record the mass of the minus 4.75 mm (No. 4) split, designate this mass as M_2 .
19. Select sieves required by the specification and those necessary to avoid overloading as described in Annex B. With a pan on bottom, nest the sieves increasing in size starting with the 75 μm (No. 200) up to, but not including, the 4.75 mm (No. 4) sieve.
20. Place the sample portion on the top sieve and place the sieves in the mechanical shaker. Shake for the minimum time determined to provide complete separation for the sieve shaker being used (approximately 10 minutes, the time determined by Annex A).
21. Determine and record the individual or cumulative mass retained for each sieve and in the pan. Ensure that all particles trapped in full openings of the sieve are removed and included in the mass retained. (See Note 5.)
22. Perform the *Fine Check Sum* calculation – Verify the *total mass after sieving* compared to the *dry mass before sieving* (M_2) is not more than 0.3 percent. Do not use test results for acceptance if the *Check Sum* result is more than 0.3 percent.
23. Calculate to the nearest 0.1 percent, the Individual Mass Retained (IMR) or Cumulative Mass Retained (CMR) of the size increment of the reduced sample and the original sample.
24. Calculate the total percent passing.
25. Report total percent passing to 1 percent except report the 75 μm (No. 200) sieve to 0.1 percent.

Method B Calculations**Check Sum**

$$\text{Coarse Check Sum} = \frac{\text{dry mass before sieving} - \text{total mass after coarse sieving}}{\text{dry mass before sieving}} \times 100$$

$$\text{Fine Check Sum} = \frac{M_2 - \text{total mass after fine sieving}}{M_2} \times 100$$

Percent Retained for 4.75 mm (No. 4) and larger

$$\text{IPR} = \frac{\text{IMR}}{M} \times 100 \quad \text{or} \quad \text{CPR} = \frac{\text{CMR}}{M} \times 100$$

Where:

IPR	=	Individual Percent Retained
CPR	=	Cumulative Percent Retained
M	=	Original dry mass of the sample
IMR	=	Individual Mass Retained
CMR	=	Cumulative Mass Retained

Percent Passing (PP) for 4.75 mm (No. 4) and larger

$$\text{PP} = \text{PPP} - \text{IPR} \quad \text{or} \quad \text{PP} = 100 - \text{CPR}$$

Where:

PP	=	Percent Passing
PPP	=	Previous Percent Passing

Minus 4.75mm (No. 4) adjustment factor (R)

The mass of material retained for each sieve is multiplied by the adjustment factor, the total mass of the minus 4.75 mm (No. 4) from the pan, M_1 , divided by the mass of the reduced split of minus 4.75 mm (No. 4), M_2 . For consistency, this adjustment factor is carried to three decimal places.

$$R = \frac{M_1}{M_2}$$

where:

- R = minus 4.75 mm (No. 4) adjustment factor
- M_1 = total mass of minus 4.75 mm (No. 4) before reducing
- M_2 = mass of the reduced split of minus 4.75 mm (No. 4)

Total Individual Mass Retained (TIMR):

$$TIMR = R \times B$$

where:

- TIMR = Total Individual Mass Retained
- R = minus 4.75 mm (No. 4) adjustment factor
- B = individual mass of the size increment in the reduced portion sieved

Total Cumulative Mass Retained (TCMR)

$$TCMR = (R \times B) + D$$

where:

- TCMR = Total Cumulative Mass Retained
- R = minus 4.75 mm (No. 4) adjustment factor
- B = cumulative mass of the size increment in the reduced portion sieved
- D = cumulative mass of plus 4.75mm (No. 4) portion of sample

AGGREGATE

WAQTC

FOP AASHTO T 27 / T 11 (22)

Method B Example Individual Mass Retained

Dry mass of total sample, before washing:	3214.0 g
Dry mass of sample after washing:	3085.1 g
Total mass after sieving	
Sum of Individual Masses Retained (IMR) plus the minus 4.75 mm (No. 4) from the pan:	3085.0 g
Amount of 75 µm (No. 200) minus washed out (3214.0 g – 3085.1 g):	128.9 g

Coarse Check Sum

$$\text{Coarse Check Sum} = \frac{3085.1 \text{ g} - 3085.0 \text{ g}}{3085.1 \text{ g}} \times 100 = 0.0\%$$

The result is not more than 0.3 percent therefore the results can be used for acceptance purposes.

Individual Percent Retained (IPR) for 9.5 mm (3/8 in.) sieve

$$\text{IPR} = \frac{481.4 \text{ g}}{3214.0 \text{ g}} \times 100 = 15.0\%$$

Percent Passing (PP) for 9.5 mm (3/8 in.) sieve:

$$\text{PP} = 95.0\% - 15.0\% = 80.0\%$$

Reported Percent Passing = 80%

**Method B Individual
Gradation on Coarse Sieves**

Sieve Size mm (in.)	Individual Mass Retained g (IMR)	Determine IPR by dividing IMR by M and multiplying by 100	Individual Percent Retained (IPR)	Determine PP by subtracting IPR from previous PP	Percent Passing (PP)
16.0 (5/8)	0		0		100
12.5 (1/2)	161.1	$\frac{161.1}{3214.0} \times 100 =$	5.0	$100.0 - 5.0 =$	95.0
9.50 (3/8)	481.4	$\frac{481.4}{3214.0} \times 100 =$	15.0	$95.0 - 15.0 =$	80.0
4.75 (No. 4)	475.8	$\frac{475.8}{3214.0} \times 100 =$	14.8	$80.0 - 14.8 =$	65.2
Minus 4.75 (No. 4) in the pan	1966.7 (M_1)				
Total mass after sieving: sum of sieves + mass in the pan = 3085.0 g					
Original dry mass of the sample (M): 3214.0 g					

Fine Sample

The minus 4.75 mm (No. 4) from the pan, M_1 (1966.7 g), was reduced according to the FOP for AASHTO R 76, to at least 500 g. In this case, the reduced mass was determined to be **512.8 g**. This is M_2 .

The reduced mass was sieved.

Total mass after sieving equals

Sum of Individual Masses Retained (IMR) including
minus 75 μ m (No. 200) in the pan 511.8 g

Fine Check Sum

$$\text{Fine Check Sum} = \frac{512.8 \text{ g} - 511.8 \text{ g}}{512.8 \text{ g}} \times 100 = 0.2\%$$

The result is not more than an 0.3 percent therefore the results can be used for acceptance purposes.

Adjustment Factor (*R*) for Total Individual Mass Retained (TIMR) on minus 4.75 (No. 4) sieves

The mass of material retained for each sieve is multiplied by the adjustment factor (*R*) carried to three decimal places.

$$R = \frac{M_1}{M_2} = \frac{1,966.7 \text{ g}}{512.8 \text{ g}} = 3.835$$

where:

- R* = minus 4.75 mm (No. 4) adjustment factor
- M*₁ = total mass of minus 4.75 mm (No. 4) from the pan
- M*₂ = mass of the reduced split of minus 4.75 mm (No. 4)

Each “individual mass retained” on the fine sieves must be multiplied by *R* to obtain the *Total Individual Mass Retained (TIMR)*.

Total Individual Mass Retained (TIMR) for 2.00 mm (No. 10) sieve

$$\text{TIMR} = 3.835 \times 207.1 \text{ g} = 794.2 \text{ g}$$

Individual Percent Retained (IPR) for 2.00 mm (No. 10) sieve:

$$\text{IPR} = \frac{794.2 \text{ g}}{3214.0 \text{ g}} \times 100 = 24.7\%$$

AGGREGATE

WAQTC

FOP AASHTO T 27 / T 11 (22)

Percent Passing (PP) 2 mm (No. 10) sieve:

$$PP = 65.2\% - 24.7\% = 40.5\%$$

Reported Percent Passing = 41%

**Method B Individual
Gradation on Fine Sieves**

Sieve Size mm (in.)	Individual Mass Retained g (IMR)	Determine TIMR by multiplying IMR by $R \left(\frac{M_1}{M_2} \right)$	Total Individual Mass Retained (TIMR)
2.00 (No. 10)	207.1	$207.1 \times 3.835 =$	794.2
0.425 (No. 40)	187.9	$187.9 \times 3.835 =$	720.6
0.210 (No. 80)	59.9	$59.9 \times 3.835 =$	229.7
0.075 (No. 200)	49.1	$49.1 \times 3.835 =$	188.3
minus 0.075 (No. 200) in the pan	7.8		
Total mass after sieving: sum of fine sieves + the mass in the pan = 511.8 g			

**Method B Individual
Final Gradation on All Sieves**

Sieve Size mm (in.)	Total Individual Mass Retained g (TIMR)	Determine IPR by dividing TIMR by M and multiplying by 100	Individual Percent Retained (IPR)	Determine PP by subtracting IPR from previous PP	Percent Passing (PP)	Reported Percent Passing*
16.0 (5/8)	0		0		100	100
12.5 (1/2)	161.1	$\frac{161.1}{3214.0} \times 100 =$	5.0	$100.0 - 5.0 =$	95.0	95
9.50 (3/8)	481.4	$\frac{481.4}{3214.0} \times 100 =$	15.0	$95.0 - 15.0 =$	80.0	80
4.75 (No. 4)	475.8	$\frac{475.8}{3214.0} \times 100 =$	14.8	$80.0 - 14.8 =$	65.2	65
2.00 (No. 10)	794.2	$\frac{794.2}{3214.0} \times 100 =$	24.7	$65.2 - 24.7 =$	40.5	41
0.425 (No. 40)	720.6	$\frac{720.6}{3214.0} \times 100 =$	22.4	$40.5 - 22.4 =$	18.1	18
0.210 (No. 80)	229.7	$\frac{229.7}{3214.0} \times 100 =$	7.1	$18.1 - 7.1 =$	11.0	11
0.075 (No. 200)	188.3	$\frac{188.3}{3214.0} \times 100 =$	5.9	$11.0 - 5.9 =$	5.1	5.1
minus 0.075 (No. 200) in the pan	29.9					
Original dry mass of the sample (M): 3214.0 g						

* Report total percent passing to 1 percent except report the 75 µm (No. 200) sieve to 0.1 percent.

AGGREGATE

WAQTC

FOP AASHTO T 27 / T 11 (22)

Method B Example Cumulative Mass Retained

Original dry mass of the sample (<i>M</i>):	3214.0 g
Dry mass of sample after washing:	3085.1 g
Total mass after sieving equals	
Cumulative Mass Retained (CMR) on the 4.75 (No. 4)	
plus the minus 4.75 mm (No. 4) in the pan:	3085.0 g
Amount of 75 µm (No. 200) minus washed out (3214.0 g – 3085.1 g):	128.9 g

Coarse Check Sum

$$\text{Coarse Check Sum} = \frac{3085.1 \text{ g} - 3085.0 \text{ g}}{3085.1 \text{ g}} \times 100 = 0.0\%$$

The result is not more than 0.3 percent therefore the results can be used for acceptance purposes.

Cumulative Percent Retained (CPR) for 9.5 mm (3/8 in.) sieve

$$CPR = \frac{642.5 \text{ g}}{3214.0 \text{ g}} \times 100 = 20.0\%$$

Percent Passing (PP) for 9.5 mm (3/8 in.) sieve

$$PP = 100.0\% - 20.0\% = 80.0\%$$

Reported Percent Passing = 80%

**Method B Cumulative
Gradation on Coarse Sieves**

Sieve Size mm (in.)	Cumulative Mass Retained g (CMR)	Determine CPR by dividing CMR by M and multiplying by 100	Cumulative Percent Retained (CPR)	Determine PP by subtracting CPR from 100.0	Percent Passing (PP)
16.0 (5/8)	0		0		100
12.5 (1/2)	161.1	$\frac{161.1}{3214.0} \times 100 =$	5.0	$100.0 - 5.0 =$	95.0
9.50 (3/8)	642.5	$\frac{642.5}{3214.0} \times 100 =$	20.0	$100.0 - 20.0 =$	80.0
4.75 (No. 4)	1118.3 (<i>D</i>)	$\frac{1118.3}{3214.0} \times 100 =$	34.8	$100.0 - 34.8 =$	65.2
Minus 4.75 (No. 4) in the pan	1966.7 (<i>M_I</i>)				
CMR: $1118.3 + 1966.7 = 3085.0$					
Original dry mass of the sample (<i>M</i>): 3214.0 g					

Fine Sample

The mass of minus 4.75 mm (No. 4) material in the pan, M_I (1966.7 g), was reduced according to the FOP for AASHTO R 76, to at least 500 g. In this case, the reduced mass was determined to be **512.8 g**. This is M_2 .

The reduced mass was sieved.

Total mass after fine sieving equals

Final Cumulative Mass Retained (FCMR) (includes minus
75 μm (No. 200) from the pan): 511.8 g

Fine Check Sum

$$\text{Fine Check Sum} = \frac{512.8 \text{ g} - 511.8 \text{ g}}{512.8 \text{ g}} \times 100 = 0.2\%$$

The result is not more than 0.3 percent therefore the results can be used for acceptance purposes.

AGGREGATE

WAQTC

FOP AASHTO T 27 / T 11 (22)

The cumulative mass of material retained for each sieve is multiplied by the adjustment factor (R) carried to three decimal places to obtain the *Adjusted Cumulative Mass Retained (ACMR)* and added to the cumulative mass retained on the 4.75 mm (No. 4) sieve, D , to obtain the *Total Cumulative Mass Retained (TCMR)*.

Adjustment factor (R) for Adjusted Cumulative Mass Retained (ACMR) in minus 4.75 (No. 4) sieves.

$$R = \frac{M_1}{M_2} = \frac{1,966.7 \text{ g}}{512.8 \text{ g}} = 3.835$$

where:

- R = minus 4.75 mm (No. 4) adjustment factor
- M_1 = total mass of minus 4.75 mm (No. 4) from the pan
- M_2 = mass of the reduced split of minus 4.75 mm (No. 4)

Adjusted Cumulative Mass Retained (ACMR) for the 2.00 mm (No. 10) sieve

$$ACMR = 3.835 \times 207.1 \text{ g} = 794.2 \text{ g}$$

Total Cumulative Mass Retained (TCMR) for the 2.00 mm (No. 10) sieve

$$TCMR = 794.2 \text{ g} + 1118.3 \text{ g} = 1912.5 \text{ g}$$

Cumulative Percent Retained (CPR) for 2.00 mm (No. 10) sieve:

$$CPR = \frac{1912.5 \text{ g}}{3214.0 \text{ g}} \times 100 = 59.5\%$$

Percent Passing (PP) 2.00 mm (No. 10) sieve:

$$PP = 100.0\% - 59.5\% = 40.5\%$$

Reported Percent Passing = 41%

**Method B Cumulative
Gradation on Fine Sieves**

Sieve Size mm (in.)	Cumulative Mass Retained, g (CMR)	Determine TCMR by multiplying CMR by $R \left(\frac{M_1}{M_2} \right)$ and adding D	Total Cumulative Mass Retained (TCMR)
2.00 (No. 10)	207.1	$207.1 \times 3.835 + 1118.3 =$	1912.5
0.425 (No. 40)	395.0	$395.0 \times 3.835 + 1118.3 =$	2633.1
0.210 (No. 80)	454.9	$454.9 \times 3.835 + 1118.3 =$	2862.8
0.075 (No. 200)	504.0	$504.0 \times 3.835 + 1118.3 =$	3051.1
FCMR	511.8		
Total: sum of masses on fine sieves + minus 75 μm (No. 200) in the pan = 511.8			

AGGREGATE

WAQTC

FOP AASHTO T 27 / T 11 (22)

**Method B Cumulative
Final Gradation on All Sieves**

Sieve Size mm (in.)	Total Cumulative Mass Retained g (TCMR)	Determine CPR by dividing CMR by M and multiplying by 100	Cumulative Percent Retained (CPR)	Determine PP by subtracting CPR from 100.0	Percent Passing (PP)	Reported Percent Passing*
16.0 (5/8)	0		0		100.0	100
12.5 (1/2)	161.1	$\frac{161.1}{3214.0} \times 100 =$	5.0	$100.0 - 5.0 =$	95.0	95
9.5 (3/8)	642.5	$\frac{642.5}{3214.0} \times 100 =$	20.0	$100.0 - 20.0 =$	80.0	80
4.75 (No. 4)	1118.3 (D)	$\frac{1118.3}{3214.0} \times 100 =$	34.8	$100.0 - 34.8 =$	65.2	65
2.00 (No. 10)	1912.5	$\frac{1912.5}{3214.0} \times 100 =$	59.5	$100.0 - 59.5 =$	40.5	41
0.425 (No. 40)	2633.1	$\frac{2633.1}{3214.0} \times 100 =$	81.9	$100.0 - 81.9 =$	18.1	18
0.210 (No. 80)	2862.8	$\frac{2862.8}{3214.0} \times 100 =$	89.1	$100.0 - 89.1 =$	10.9	11
0.075 (No. 200)	3051.1	$\frac{3051.1}{3214.0} \times 100 =$	94.9	$100.0 - 94.9 =$	5.1	5.1
FCMR	3081.1					
Original dry mass of the sample (M): 3214.0 g						

* Report total percent passing to 1 percent except report the 75 μ m (No. 200) sieve to 0.1 percent.

Procedure Method C

1. Dry the sample to constant mass at $110 \pm 5^\circ\text{C}$ ($230 \pm 9^\circ\text{F}$) according to the FOP for AASHTO T 255. Cool to room temperature.
2. Determine and record the original dry mass of the sample to the nearest 0.1 percent or 0.1 g. Designate this mass as M .
3. Break up any aggregations or lumps of clay, silt, or adhering fines to pass the 4.75 mm (No. 4) sieve.
4. Select sieves required by the specification and those necessary to avoid overloading as described in Annex B. With a pan on bottom, nest the sieves increasing in size starting with the 4.75 mm (No. 4) sieve.
5. Place the sample, or a portion of the sample, on the top sieve. Sieves may already be in the mechanical shaker, if not place the sieves in the mechanical shaker and shake for the minimum time determined to provide complete separation for the sieve shaker being used (approximately 10 minutes, the time determined by Annex A).

Note 1: Excessive shaking (more than 10 minutes) may result in degradation of the sample.

6. Determine and record the cumulative mass retained for each sieve. Ensure that all material trapped in full openings of the sieve are removed and included in the mass retained.

Note 2: For sieves 4.75 mm (No. 4) and larger, check material trapped in less than a full opening sieving over a full opening. Use coarse wire brushes to clean the 600 μm (No. 30) and larger sieves, and soft bristle brush for smaller sieves.

7. Determine and record the mass of the minus 4.75 mm (No. 4) material in the pan. Designate this mass as M_1 .
8. Perform the *Coarse Check Sum* calculation –Verify the *total mass after coarse sieving* compared to the *original dry mass (M)* is not more than 0.3 percent.
9. Reduce the minus 4.75 mm (No. 4) according to the FOP for AASHTO R 76, to produce a sample with a minimum mass of 500 g.
10. Determine and record the mass of the minus 4.75 mm (No. 4) split, designate this mass as M_3 .
11. Nest a protective sieve, such as a 2.0 mm (No. 10), above the 75 μm (No. 200) sieve.
12. Place the sample in a container and cover with water.

Note 3: A detergent, dispersing agent, or other wetting solution may be added to the water to assure a thorough separation of the material finer than the 75 μm (No. 200) sieve from the coarser particles. There should be enough wetting agent to produce a small amount of suds when the sample is agitated. Excessive suds may overflow the sieves and carry material away with them.

13. Agitate vigorously to ensure complete separation of the material finer than 75 μm (No. 200) from coarser particles and bring the fine material into suspension above the coarser material. Avoid degradation of the sample when using a mechanical washing device.

Note 4: Washing longer than 10 minutes in a mechanical washer has been shown to cause significant amounts of degradation depending upon aggregate type.

14. Immediately pour the wash water containing the suspended material over the nested sieves; be careful not to pour out the coarser particles or over fill the 75 μm (No. 200) sieve.
15. Add water to cover material remaining in the container, agitate, and repeat Step 12. Repeat until the wash water is reasonably clear.
16. Remove the upper sieve and return material retained to the washed sample.
17. Rinse the material retained on the 75 μm (No. 200) sieve until water passing through the sieve is reasonably clear and detergent or dispersing agent is removed, if used.
18. Return all material retained on the 75 μm (No. 200) sieve to the container by flushing into the washed sample.

Note 5: Excess water may be carefully removed with a bulb syringe; the removed water must be discharged back over the 75 μm (No. 200) sieve to prevent loss of fines.

19. Dry the washed sample portion to constant mass at $110 \pm 5^\circ\text{C}$ ($230 \pm 9^\circ\text{F}$) according to the FOP for AASHTO T 255. Cool to room temperature. Determine and record the dry mass, designate this mass as *dry mass before sieving*.
20. Select sieves required by the specification and those necessary to avoid overloading as described in Annex B. With a pan on bottom, nest the sieves increasing in size starting with the 75 μm (No. 200) sieve up to, but not including the 4.75 mm (No. 4) sieve.
21. Place the sample portion on the top sieve. Place the sieves in the mechanical shaker and shake for the minimum time determined to provide complete separation for the sieve shaker being used (approximately 10 minutes, the time determined by Annex A).

Note 6: Excessive shaking (more than 10 minutes) may result in degradation of the sample.

22. Determine and record the cumulative mass retained for each sieve. Ensure that all material trapped in full openings of the sieve are removed and included in the mass retained.

Note 7: For sieves 4.75 mm (No. 4) and larger, check material trapped in less than a full opening by sieving over a full opening. Use coarse wire brushes to clean the 600 μm (No. 30) and larger sieves, and soft bristle brushes for smaller sieves.

23. Perform the *Fine Check Sum* calculation – Verify the *total mass after fine sieving* compared to the *dry mass before sieving* is not more than 0.3 percent. Do not use test results for acceptance if the *Check Sum* is more than 0.3 percent.
24. Calculate the Cumulative Percent Retained (CPR) and Percent Passing (PP) for the 4.75 mm (No. 4) and larger.
25. Calculate the Cumulative Percent Retained (CPR_{#4}) and the Percent Passing (PP_{#4}) for minus 4.75 mm (No. 4) split and Percent Passing (PP) for the minus 4.75 mm (No. 4).
26. Report total percent passing to 1 percent except report the 75 μm (No. 200) sieve to 0.1 percent.

Method C Calculations**Check Sum**

$$\text{Coarse check sum} = \frac{M - \text{total mass after coarse sieving}}{M} \times 100$$

$$\text{Fine check sum} = \frac{\text{dry mass before sieving} - \text{total mass after fine sieving}}{\text{dry mass before sieving}} \times 100$$

where:

M = Original dry mass of the sample

Cumulative Percent Retained (CPR) for 4.75 mm (No. 4) sieve and larger

$$CPR = \frac{CMR}{M} \times 100$$

where:

CPR = Cumulative Percent Retained of the size increment for the total sample

CMR = Cumulative Mass Retained of the size increment for the total sample

M = Total dry sample mass before washing

Percent Passing (PP) 4.75 mm (No. 4) sieve and larger

$$PP = 100 - CPR$$

where:

PP = Percent Passing of the size increment for the total sample

CPR = Cumulative Percent Retained of the size increment for the total sample

AGGREGATE

WAQTC

FOP AASHTO T 27 / T 11 (22)

Or calculate PP for sieves larger than 4.75 mm (No. 4) sieve without calculating CPR

$$\frac{M - CMR}{M} \times 100$$

Cumulative Percent Retained (CPR_{#4}) for minus 4.75 mm (No. 4) split

$$CPR_{\#4} = \frac{CMR_{\#4}}{M_3} \times 100$$

where:

- CPR_{#4} = Cumulative Percent Retained for the sieve sizes of M₃
 CMR_{#4} = Cumulative Mass Retained for the sieve sizes of M₃
 M₃ = Total mass of the minus 4.75 mm (No. 4) split before washing

Percent Passing (PP_{#4}) for minus 4.75 mm (No. 4) split

$$PP_{\#4} = 100 - CPR_{\#4}$$

where:

- PP_{#4} = Percent Passing for the sieve sizes of M₃
 CPR_{#4} = Cumulative Percent Retained for the sieve sizes of M₃

Percent Passing (PP) for sieves smaller than 4.75 mm (No. 4) sieve

$$PP = \frac{(PP_{\#4} \times \#4 PP)}{100}$$

where:

- PP = Total Percent Passing
 PP_{#4} = Percent Passing for the sieve sizes of M₃
 #4 PP = Total Percent Passing the 4.75 mm (No. 4) sieve

AGGREGATE

WAQTC

FOP AASHTO T 27 / T 11 (22)

Or calculate PP for sieves smaller than 4.75 mm (No. 4) sieve without calculating CPR_{#4} and PP_{#4}

$$PP = \frac{\#4 PP}{M_3} \times (M_3 - CMR_{\#4})$$

where:

- PP = Total Percent Passing
 #4 PP = Total Percent Passing the 4.75 mm (No. 4) sieve
 M₃ = Total mass of the minus 4.75 mm (No. 4) split before washing
 CMR_{#4} = Cumulative Mass Retained for the sieve sizes of M₃

Method C Example

Original dry mass of the sample (*M*): 3304.5 g

Total mass after sieving equals

Cumulative Mass Retained (CMR) on the 4.75 (No. 4) plus the minus 4.75 mm (No. 4) from the pan: 3085.0 g

Coarse Check Sum

$$\text{Coarse Check Sum} = \frac{3304.5 \text{ g} - 3304.5 \text{ g}}{3304.5 \text{ g}} \times 100 = 0.0\%$$

The result is not more than 0.3 percent therefore the results can be used for acceptance purposes.

Cumulative Percent Retained (CPR) for the 9.5 mm (3/8 in.) sieve:

$$CPR = \frac{604.1 \text{ g}}{3304.5 \text{ g}} \times 100 = 18.3\%$$

AGGREGATE

WAQTC

FOP AASHTO T 27 / T 11 (22)

Percent Passing (PP) for the 9.5 mm (3/8 in.) sieve:

$$PP = 100.0\% - 18.3\% = 81.7\%$$

Reported Percent Passing = 82%

Example for Alternate Percent Passing (PP) formula for the 9.5 mm (3/8 in.) sieve:

$$PP = \frac{3304.5 - 604.1}{3304.5} \times 100 = 81.7\%$$

Reported Percent Passing = 82%

**Method C Cumulative
Gradation on Coarse Sieves**

Sieve Size mm (in.)	Cumulative Mass Retained, g (CMR)	Determine CPR by dividing CMR by M and multiplying by 100	Cumulative Percent Retained (CPR)	Determine PP by subtracting CPR from 100.0	Percent Passing (PP)	Reported Percent Passing*
16.0 (5/8)	0		0.0		100.0	100
12.5 (1/2)	125.9	$\frac{125.9}{3304.5} \times 100 =$	3.8	$100.0 - 3.8 =$	96.2	96
9.50 (3/8)	604.1	$\frac{604.1}{3304.5} \times 100 =$	18.3	$100.0 - 18.3 =$	81.7	82
4.75 (No. 4)	1295.6	$\frac{1295.6}{3304.5} \times 100 =$	39.2	$100.0 - 39.2 =$	60.8 (#4 PP)	61
Mass in pan	2008.9					
CMR: $1295.6 + 2008.9 = 3304.5$						
Original dry mass of the sample (M): 3304.5						

AGGREGATE

WAQTC

FOP AASHTO T 27 / T 11 (22)

Fine Sample

The pan (2008.9 g) was reduced according to the FOP for AASHTO R 76, to at least 500 g. In this case, the reduced mass was determined to be **527.6 g**. This is M_3 .

Dry mass of minus 4.75mm (No. 4) reduced portion before wash (M_3): 527.6 g

Dry mass of minus 4.75mm (No. 4) reduced portion after wash: 495.3 g

Total mass after fine sieving equals

Final Cumulative Mass Retained (FCMR)
(includes minus 75 μm (No. 200) from the pan): 495.1 g

Fine Check Sum

$$\text{Fine Check Sum} = \frac{495.3 \text{ g} - 495.1 \text{ g}}{495.3 \text{ g}} \times 100 = 0.0\%$$

The result is not more than 0.3 percent therefore the results can be used for acceptance purposes.

Cumulative Percent Retained (CPR_{#4}) for minus 4.75 mm (No. 4) for the 2.0 mm (No. 10) sieve:

$$CPR_{\#4} = \frac{194.3 \text{ g}}{527.6 \text{ g}} \times 100 = 36.8\%$$

Percent Passing (PP_{#4}) for minus 4.75 mm (No. 4) for the 2.0 mm (No. 10) sieve:

$$PP_{\#4} = 100.0\% - 36.8\% = 63.2\%$$

**Method C Cumulative
Gradation on Fine Sieves**

77

Sieve Size mm (in.)	Cumulative Mass Retained g (CMR _{#4})	Determine CPR _{#4} by dividing CMR by M ₃ and multiplying by 100	Cumulative Percent Retained _{#4} (CPR _{#4})	Determine PP _{#4} by subtracting CPR _{#4} from 100.0	Percent Passing _{#4} (PP _{#4})
2.0 (No. 10)	194.3	$\frac{194.3}{527.6} \times 100 =$	36.8	$100.0 - 36.8 =$	63.2
0.425 (No. 40)	365.6	$\frac{365.6}{527.6} \times 100 =$	69.3	$100.0 - 69.3 =$	30.7
0.210 (No. 80)	430.8	$\frac{430.8}{527.6} \times 100 =$	81.7	$100.0 - 81.7 =$	18.3
0.075 (No. 200)	484.4	$\frac{484.4}{527.6} \times 100 =$	91.8	$100.0 - 91.8 =$	8.2
FCMR	495.1				
Dry mass of minus 4.75mm (No. 4) reduced portion before wash (M ₃): 527.6 g					
Dry mass after washing: 495.3 g					

Percent Passing (PP) for the 2.0 mm (No. 10) sieve for the entire sample:

78

#4 PP (Total Percent Passing the 4.75 mm (No. 4) sieve) = 60.8%

$$PP = \frac{63.2\% \times 60.8\%}{100} = 38.4\%$$

Reported Percent Passing = 38%

**Method C Cumulative
Final Gradation on All Sieves**

Sieve Size mm (in.)	Cumulative Mass Retained g (CMR)	Cumulative Percent Retained (CPR)	Percent Passing (PP -#4)	Determine PP by multiplying PP-#4 by #4 PP and dividing by 100	Percent Passing (PP)	Reported Percent Passing*
16.0 (5/8)	0	0.0			100.0	100
12.5 (1/2)	125.9	3.8			96.2	96
9.5 (3/8)	604.1	18.3			81.7	82
4.75 (No. 4)	1295.6	39.2			60.8 (#4 PP)	61
2.0 (No. 10)	194.3	36.8	63.2	$\frac{63.2 \times 60.8}{100} =$	38.4	38
0.425 (No. 40)	365.6	69.3	30.7	$\frac{30.7 \times 60.8}{100} =$	18.7	19
0.210 (No. 80)	430.8	81.7	18.3	$\frac{18.3 \times 60.8}{100} =$	11.1	11
0.075 (No. 200)	484.4	91.8	8.2	$\frac{8.2 \times 60.8}{100} =$	5.0	5.0
FCMR	495.1					

* Report total percent passing to 1 percent except report the 75 µm (No. 200) sieve to 0.1 percent.

AGGREGATE

WAQTC

FOP AASHTO T 27 / T 11 (22)

Example for Alternate Percent Passing (PP) for the 4.75 mm (No. 4) sieve for the entire sample:

#4 PP (Total Percent Passing the 4.75 mm (No. 4) sieve) = 60.8%

$$PP = \frac{60.8\%}{527.6} \times (527.6 - 194.3) = 38.4\%$$

Reported Percent Passing = 38%

**Alternate Method C Cumulative
Gradation on Coarse Sieves**

Sieve Size mm (in.)	Cumulative Mass Retained, g (CMR)	Determine PP by subtracting CMR from M, and dividing the result by M then multiplying by 100	Percent Passing (PP)	Reported Percent Passing*
16.0 (5/8)	0.0		100.0	100
12.5 (1/2)	125.9	$\frac{3304.5 - 125.9}{3304.5} \times 100 =$	96.2	96
9.5 (3/8)	604.1	$\frac{3304.5 - 604.1}{3304.5} \times 100 =$	81.7	82
4.75 (No. 4)	1295.6	$\frac{3304.5 - 1295.6}{3304.5} \times 100 =$	60.8 (#4 PP)	61
Mass in Pan	2008.9			
Cumulative sieved mass: 1295.6 + 2008.9 = 3304.5				
Original dry mass of the sample (M): 3304.5				

**Alternate Method C Cumulative
Gradation on Fine Sieves**

Sieve Size mm (in.)	Cumulative Mass Retained g (CMR _{#4})	Determine PP _{#4} by subtracting CMR _{#4} from M ₃ , dividing result by M ₃ and multiplying by 100	Percent Passing _{#4} (PP _{#4})
2.0 (No. 10)	194.3	$\frac{527.6 - 194.3}{527.6} \times 100 =$	63.2
0.425 (No. 40)	365.6	$\frac{527.6 - 365.6}{527.6} \times 100 =$	30.7
0.210 (No. 80)	430.8	$\frac{527.6 - 430.8}{527.6} \times 100 =$	18.3
0.075 (No. 200)	484.4	$\frac{527.6 - 484.4}{527.6} \times 100 =$	8.2
FCMR	495.1		
Dry mass of minus 4.75mm (No. 4) reduced portion before wash (M ₃): 527.6 g			
Dry mass after washing: 495.3 g			

AGGREGATE

WAQTC

FOP AASHTO T 27 / T 11 (22)

**Alternate Method C Cumulative
Final Gradation on All Sieves**

Sieve Size mm (in.)	Percent Passing _{#4} (PP _{#4})	Determine PP by multiplying PP _{#4} by #4 PP and dividing by 100	Determined Percent Passing (PP)	Reported Percent Passing*
16.0 (5/8)			100.0	100
12.5 (1/2)			96.2	96
9.5 (3/8)			81.7	82
4.75 (No. 4)			60.8 (#4 PP)	61
2.0 (No. 10)	63.2	$\frac{63.2 \times 60.8}{100} =$	38.4	38
0.425 (No. 40)	30.7	$\frac{30.7 \times 60.8}{100} =$	18.7	19
0.210 (No. 80)	18.3	$\frac{18.3 \times 60.8}{100} =$	11.1	11
0.075 (No. 200)	8.2	$\frac{8.2 \times 60.8}{100} =$	5.0	5.0

* Report total percent passing to 1 percent except report the 75 μm (No. 200) sieve to 0.1 percent.

FINENESS MODULUS

Fineness Modulus (FM) is used in determining the degree of uniformity of the aggregate gradation in PCC mix designs. It is an empirical number relating to the fineness of the aggregate. The higher the FM the coarser the aggregate. Values of 2.40 to 3.00 are common for fine aggregate in PCC.

The sum of the cumulative percentages retained on specified sieves in the following table divided by 100 gives the FM.

Sample Calculation

	Example A			Example B		
	Percent			Percent		
		Retained			Retained	
Sieve Size mm (in)	Passing		On Spec'd Sieves*	Passing		On Spec'd Sieves*
75*(3)	100	0	0	100	0	0
37.5*(11/2)	100	0	0	100	0	0
19*(3/4)	15	85	85	100	0	0
9.5*(3/8)	0	100	100	100	0	0
4.75*(No.4)	0	100	100	100	0	0
2.36*(No.8)	0	100	100	87	13	13
1.18*(No.16)	0	100	100	69	31	31
0.60*(No.30)	0	100	100	44	56	56
0.30*(No.50)	0	100	100	18	82	82
0.15*(100)	0	100	100	4	96	96
			$\Sigma = 785$			$\Sigma = 278$
			FM = 7.85			FM = 2.78

In decreasing size order, each * sieve is one-half the size of the preceding * sieve.

Report

- On forms approved by the agency
- Sample ID
- Percent passing for each sieve
- Individual mass retained for each sieve
- Individual percent retained for each sieve
- or
- Cumulative mass retained for each sieve
- Cumulative percent retained for each sieve
- FM to the nearest 0.01

Report percentages to the nearest 1 percent except for the percent passing the 75 μm (No. 200) sieve, which shall be reported to the nearest 0.1 percent.

ANNEX A**Time Evaluation**

(Mandatory information)

The sieving time for each mechanical sieve shaker shall be checked at least annually to determine the time required for complete separation of the sample by the following method:

1. Shake the sample over nested sieves for approximately 10 minutes.
2. Provide a snug-fitting pan and cover for each sieve and hold in a slightly inclined position in one hand.
3. Hand shake each sieve by striking the side of the sieve sharply and with an upward motion against the heel of the other hand at the rate of about 150 times per minute, turning the sieve about one sixth of a revolution at intervals of about 25 strokes.

Note A1: A mallet may be used instead of the heel of the hand if comparable force is used.

If more than 0.5 percent by mass of the total sample before sieving passes any sieve after one minute of continuous hand shaking adjust shaker time and re-check.

In determining sieving time for sieve sizes larger than 4.75 mm (No. 4), limit the material on the sieve to a single layer of particles.

ANNEX B**Overload Determination**

(Mandatory information)

Additional sieves may be necessary to keep from overloading sieves or to provide other information, such as fineness modulus. The sample may also be sieved in increments to prevent overloading.

- For sieves with openings smaller than 4.75 mm (No. 4), the mass retained on any sieve shall not exceed 7 kg/m² (4 g/in²) of sieving surface.
- For sieves with openings 4.75 mm (No. 4) and larger, the mass, in grams shall not exceed the product of 2.5 × (sieve opening in mm) × (effective sieving area). See Table B1.

TABLE B1

Maximum Allowable Mass of Material Retained on a Sieve, g
Nominal Sieve Size, mm (in.)
Exact size is smaller (see AASHTO T 27)

Sieve Size		203 dia	305 dia	305 by 305	350 by 350	372 by 580
mm (in.)		(8)	(12)	(12 × 12)	(14 × 14)	(16 × 24)
		Sieving Area m ²				
		0.0285	0.0670	0.0929	0.1225	0.2158
90	(3 1/2)	*	15,100	20,900	27,600	48,500
75	(3)	*	12,600	17,400	23,000	40,500
63	(2 1/2)	*	10,600	14,600	19,300	34,000
50	(2)	3600	8400	11,600	15,300	27,000
37.5	(1 1/2)	2700	6300	8700	11,500	20,200
25.0	(1)	1800	4200	5800	7700	13,500
19.0	(3/4)	1400	3200	4400	5800	10,200
16.0	(5/8)	1100	2700	3700	4900	8600
12.5	(1/2)	890	2100	2900	3800	6700
9.5	(3/8)	670	1600	2200	2900	5100
6.3	(1/4)	440	1100	1500	1900	3400
4.75	(No. 4)	330	800	1100	1500	2600
-4.75	(-No. 4)	200	470	650	860	1510

AGGREGATE

WAQTC

FOP AASHTO T 27 / T 11 (22)

AGGREGATE

WAQTC

FOP AASHTO T 27/T 11 (17)

PERFORMANCE EXAM CHECKLIST**METHOD A****SIEVE ANALYSIS OF FINE AND COARSE AGGREGATES****FOP FOR AASHTO T 27****MATERIALS FINER THAN 75 μm (No. 200) SIEVE IN MINERAL AGGREGATE BY WASHING****FOP FOR AASHTO T 11**

Participant Name _____ Exam Date _____

Record the symbols "P" for passing or "F" for failing on each step of the checklist.

Procedure Element	Trial 1	Trial 2
1. Minimum sample mass meets requirement of Table 1?	_____	_____
2. Sample dried to a constant mass by FOP for AASHTO T 255 at $110 \pm 5^\circ\text{C}$ ($230 \pm 9^\circ\text{F}$)?	_____	_____
3. Sample cooled, and original dry mass of the sample recorded to the nearest 0.1 percent or 0.1 g?	_____	_____
4. Sample placed in container and covered with water?	_____	_____
5. Contents of the container vigorously agitated?	_____	_____
6. Suspension of minus 75 μm (No. 200) achieved?	_____	_____
7. Wash water poured through nested sieves such as 2 mm (No. 10) and 75 μm (No. 200)?	_____	_____
8. Operation continued until wash water is reasonably clear?	_____	_____
9. Material retained on sieves returned to washed sample?	_____	_____
10. Washed sample dried to a constant mass by FOP for AASHTO T 255 at $110 \pm 5^\circ\text{C}$ ($230 \pm 9^\circ\text{F}$)?	_____	_____
11. Washed sample cooled, and dry mass recorded to the nearest 0.1 percent or 0.1 g?	_____	_____
12. Sample placed in nest of sieves specified? (Additional sieves may be used to prevent overloading as allowed in FOP.)	_____	_____
13. Material sieved in verified mechanical shaker for proper time?	_____	_____
14. Mass of material on each sieve and pan recorded to 0.1 g?	_____	_____
15. Total mass of material after sieving compared to the mass before sieving is not more than 0.3 percent (check sum)?	_____	_____

OVER

AGGREGATE

WAQTC

FOP AASHTO T 27/T 11 (17)

Procedure Element

Trial 1 Trial 2

16. Percentages calculated to the nearest 0.1 percent and reported to the nearest whole number, except 75 μm (No. 200) which is reported to the nearest 0.1 percent?

17. Percentage calculations based on original dry mass of the sample?

18. Calculations performed properly?

Comments: First attempt: Pass____Fail____ Second attempt: Pass____Fail____

Examiner Signature _____ **WAQTC #:** _____

PERFORMANCE EXAM CHECKLIST**METHOD B****SIEVE ANALYSIS OF FINE AND COARSE AGGREGATES****FOP FOR AASHTO T 27****MATERIALS FINER THAN 75 μm (No. 200) SIEVE IN MINERAL AGGREGATE
BY WASHING****FOP FOR AASHTO T 11**

Participant Name _____ Exam Date _____

Record the symbols "P" for passing or "F" for failing on each step of the checklist.

Procedure Element	Trial 1	Trial 2
1. Minimum sample mass meets requirement of Table 1?	_____	_____
2. Sample dried to a constant mass by FOP for AASHTO T 255 at $110 \pm 5^\circ\text{C}$ ($230 \pm 9^\circ\text{F}$)?	_____	_____
3. Sample cooled, and original dry mass of the sample recorded to the nearest 0.1 percent or 0.1 g?	_____	_____
4. Sample placed in container and covered with water?	_____	_____
5. Contents of the container vigorously agitated?	_____	_____
6. Suspension of minus 75 μm (No. 200) achieved?	_____	_____
7. Wash water poured through nested sieves such as 2 mm (No. 10) and 75 μm (No. 200)?	_____	_____
8. Operation continued until wash water is reasonably clear?	_____	_____
9. Material retained on sieves returned to washed sample?	_____	_____
10. Washed sample dried to a constant mass by FOP for AASHTO T 255 at $110 \pm 5^\circ\text{C}$ ($230 \pm 9^\circ\text{F}$)?	_____	_____
11. Washed sample cooled, and dry mass recorded to nearest 0.1 percent or 0.1 g?	_____	_____
12. Sample placed in nest of sieves specified? (Additional sieves may be used to prevent overloading as allowed in FOP.)	_____	_____
13. Material sieved in verified mechanical shaker for proper time?	_____	_____
14. Mass of material on each sieve and pan determined to the nearest 0.1 percent or 0.1 g?	_____	_____
15. Total mass of material after sieving compared to the mass before sieving is not more than 0.3 percent (coarse check sum)?	_____	_____

OVER

AGGREGATE

WAQTC

FOP AASHTO T 27/T 11 (22)

Procedure Element

Trial 1 Trial 2

16. Material in pan reduced in accordance with FOP for AASHTO R 76 to at least 500 g?

17. Mass of minus 4.75 mm (No. 4) split recorded to the nearest 0.1 g?

18. Sample placed in nest of sieves specified? (Additional sieves may be used to prevent overloading as allowed in FOP.)

19. Material sieved in verified mechanical shaker for proper time?

20. Mass of material on each sieve and pan recorded to the nearest percent or 0.1 g?

21. Total mass of material after sieving compared to the mass before sieving is not more than 0.3 percent (fine check sum)?

22. Percentages calculated to the nearest 0.1 percent and reported to the nearest whole number, except 75 µm (No. 200) which is reported to the nearest 0.1 percent?

23. Percentage calculations based on original dry mass of the sample?

24. Calculations performed properly?

Comments: First attempt: Pass _____ Fail _____ Second attempt: Pass _____ Fail _____

Examiner Signature _____ **WAQTC #:** _____

WSDOT Errata to FOP for AASHTO T 30

Mechanical Analysis of Extracted Aggregate

WAQTC FOP for AASHTO T 30 has been adopted by WSDOT with the following changes:

Procedure

17. *Step not recognized by WSDOT.*

MECHANICAL ANALYSIS OF EXTRACTED AGGREGATE FOP FOR AASHTO T 30

Scope

This procedure covers mechanical analysis of aggregate recovered from asphalt mix samples in accordance with AASHTO T 30-21. This FOP uses the aggregate recovered from the ignition furnace used in AASHTO T 308. AASHTO T 30 was developed for analysis of extracted aggregate and thus includes references to extracted bitumen and filter element, which do not apply in this FOP.

Sieve analyses determine the gradation or distribution of aggregate particles within a given sample to determine compliance with design and production standards.

Apparatus

- Balance or scale: Capacity sufficient for the sample mass, accurate to 0.1 percent of the sample mass or readable to 0.1 g and conforming to AASHTO M 231.
- Sieves, meeting the requirements of FOP for AASHTO T 27/T 11.
- Mechanical sieve shaker, meeting the requirements of FOP for AASHTO T 27/T 11.
- Mechanical Washing Apparatus (optional).
- Suitable drying equipment, meeting the requirements of the FOP for AASHTO T 255.
- Containers and utensils: A pan or vessel of a size sufficient to contain the sample covered with water and to permit vigorous agitation without loss of any part of the sample or water.
- Wetting Agent: Any dispersing agent, such as dishwashing detergent, that will promote separation of the fine materials.

Sample Sieving

- In this procedure, it is required to shake the sample over nested sieves. Sieves are selected to furnish information required by specification. Intermediate sieves are added for additional information or to avoid overloading sieves, or both.
- The sieves are nested in order of increasing size from the bottom to the top, and the test sample, or a portion of the test sample, is placed on the top sieve.
- The loaded sieves are shaken in a mechanical shaker for approximately 10 minutes, refer to Annex A; *Time Evaluation*.

Mass Verification

The aggregate sample mass, $M_{(T30)}$, determined in this method, shall agree with the mass of the aggregate remaining after ignition, M_f from the FOP for AASTHO T 308, within 0.10 percent. If the variation exceeds 0.10 percent, the results cannot be used for acceptance.

Procedure

1. Determine and record the mass of the sample that was removed from the basket in the FOP for AASHTO T 308 to 0.1 g. Designate this mass as $M_{(T30)}$.
2. Verify the mass of the sample is within 0.10 percent by subtracting $M_{(T30)}$ from $M_{f(T308)}$ dividing by $M_{f(T308)}$ and multiply by 100 (see *Mass Verification Calculation* and example).
If the variation exceeds 0.10 percent, the sieve analysis results cannot be used for acceptance.
3. Nest a sieve, such as a 2.0 mm (No. 10) or 1.18 mm (No. 16), above the 75 μ m (No. 200) sieve.
4. Place the test sample in a container and cover with water. Add a wetting agent to the water to assure a thorough separation of the material finer than the 75 μ m (No. 200) sieve from the coarser particles. There should be enough wetting agent to produce a small amount of suds when the sample is agitated. Excessive suds may overflow the sieves and carry material away with them.
5. Agitate vigorously to ensure complete separation of the material finer than 75 μ m (No. 200) from coarser particles and bring the fine material into suspension above the coarser material. Avoid degradation of the sample when using a mechanical washing device. Maximum agitation is 10 min.

Note 1: When mechanical washing equipment is used, the introduction of water, agitating, and decanting may be a continuous operation. Use care not to overflow or overload the 75 μ m (No. 200) sieve.

6. Immediately pour the wash water containing the suspended material over the nested sieves; be careful not to pour out the coarser particles or over fill the 75 μ m (No. 200) sieve.
7. Add water to cover material remaining in the container, agitate, and repeat Step 6. Continue until the wash water is reasonably clear.
8. Remove the upper sieve, return material retained to the washed sample.
9. Rinse the material retained on the 75 μ m (No. 200) sieve until water passing through the sieve is reasonably clear and wetting agent is removed.
10. Return all material retained on the 75 μ m (No. 200) sieve to the washed sample by rinsing into the washed sample.
11. Dry the washed test sample to constant mass according to the FOP for AASHTO T 255. Cool to room temperature. Determine and record the “dry mass after washing.”
12. Select sieves required by the specification and those necessary to avoid overloading. (See Annex B.) With a pan on bottom, nest the sieves increasing in size starting with the 75 μ m (No. 200).
13. Place the test sample, or a portion of the test sample, on the top sieve. Place sieves in mechanical shaker and shake for the minimum time determined to provide complete separation for the sieve shaker being used (approximately 10 minutes, the time determined by Annex A).

Note 2: Excessive shaking (more than 10 minutes) may result in degradation of the sample.

14. Determine and record the individual or cumulative mass retained for each sieve including the pan. Ensure that all material trapped in full openings of the sieves are removed and included in the mass retained.

Note 3: For sieves 4.75 mm (No. 4) and larger, check material trapped in less than a full opening by sieving over a full opening. Use coarse wire brushes to clean the 600 µm (No. 30) and larger sieves, and soft bristle brushes for smaller sieves.

15. Perform the *Check Sum* calculation – Verify the *total mass after sieving* of material compared to the *dry mass after washing* is not more than 0.2 percent. Do not use test results for acceptance if the *Check Sum* result is more than 0.2 percent.

16. Calculate the total percentages passing, and the individual or cumulative percentages retained, to the nearest 0.1 percent by dividing the individual sieve masses or cumulative sieve masses by the total mass of the initial dry sample.

17. Apply the Aggregate Correction Factor (ACF) to the calculated percent passing, as required in the FOP for AASHTO T 308 “Correction Factor,” to obtain the reported percent passing.

18. Report total percent passing to 1 percent except report the 75 µm (No. 200) sieve to 0.1 percent.

Calculations

Mass verification

$$\text{Mass verification} = \frac{M_{f(T308)} - M_{(T30)}}{M_{f(T308)}} \times 100$$

Where:

$M_{f(T308)}$ = Mass of aggregate remaining after ignition from the FOP for AASHTO T 308

$M_{(T30)}$ = Mass of aggregate sample obtained from the FOP for AASHTO T 308

Check Sum

$$\text{check sum} = \frac{\text{dry mass after washing} - \text{total mass after sieving}}{\text{dry mass after washing}} \times 100$$

ASPHALT

WAQTC

FOP AASHTO T 30 (22)

Percent Retained**Individual**

$$IPR = \frac{IMR}{M_{T30}} \times 100$$

Cumulative

$$CPR = \frac{CMR}{M_{T30}} \times 100$$

Where:

IPR	=	Individual Percent Retained
CPR	=	Cumulative Percent Retained
M_{T30}	=	Total dry sample mass before washing
IMR	=	Individual Mass Retained
CMR	=	Cumulative Mass Retained

Percent Passing**Individual**

$$PP = PCP - IPR$$

Cumulative

$$PP = 100 - CPR$$

Where:

PP	=	Calculated Percent Passing
PCP	=	Previous Calculated Percent Passing

ASPHALT

WAQTC

FOP AASHTO T 30 (22)

Reported Percent Passing

$$RPP = PP + ACF$$

Where:

RPP = Reported Percent Passing

ACF = Aggregate Correction Factor (if applicable)

Example**Mass verification**

$$\text{Mass verification} = \frac{2422.5 \text{ g} - 2422.3 \text{ g}}{2422.5 \text{ g}} \times 100 = 0.01\%$$

Given:

$$M_{f(T308)} = 2422.5 \text{ g}$$

$$M_{(T30)} = 2422.3 \text{ g}$$

Dry mass of total sample, before washing (M_{T30}): 2422.3 gDry mass of sample, after washing out the 75 μm (No. 200) minus: 2296.2 gAmount of 75 μm (No. 200) minus washed out ($2422.3 \text{ g} - 2296.2 \text{ g}$): 126.1 g**Check sum**

$$\text{check sum} = \frac{2296.2 \text{ g} - 2295.3 \text{ g}}{2296.2 \text{ g}} \times 100 = 0.0\%$$

This is not more than 0.2 percent therefore the results can be used for acceptance purposes.

ASPHALT

WAQTC

FOP AASHTO T 30 (22)

Percent Retained for the 75 µm (No. 200) sieve

$$IPR = \frac{63.5 \text{ g}}{2422.3 \text{ g}} \times 100 = 2.6\%$$

or

$$CPR = \frac{2289.6 \text{ g}}{2422.3 \text{ g}} \times 100 = 94.5\%$$

Percent Passing using IPR and PCP for the 75 µm (No. 200) sieve

$$PP = 8.1\% - 2.6\% = 5.5\%$$

Percent Passing using CPR for the 75 µm (No. 200) sieve

$$PP = 100.0\% - 94.5\% = 5.5\%$$

Reported Percent Passing

$$RPP = 5.5\% + (-0.6\%) = 4.9\%$$

ASPHALT

WAQTC

FOP AASHTO T 30 (22)

**Individual
Gradation on All Sieves**

Sieve Size mm (in.)	Individual Mass Retained g (IMR)	Determine IPR by dividing IMR by <i>M</i> and multiplying by 100	Individual Percent Retained (IPR)	Determine PP by subtracting IPR from Previous PP	Percent Passing (PP)	Agg. Corr. Factor from T 308 (ACF)	Reported Percent Passing*
19.0 (3/4)	0		0		100.0		100
12.5 (1/2)	346.9	$\frac{346.9}{2422.3} \times 100 =$	14.3	$100.0 - 14.3 =$	85.7		86
9.5 (3/8)	207.8	$\frac{207.8}{2422.3} \times 100 =$	8.6	$85.7 - 8.6 =$	77.1		77
4.75 (No. 4)	625.4	$\frac{625.4}{2422.3} \times 100 =$	25.8	$77.1 - 25.8 =$	51.3		51
2.36 (No. 8)	416.2	$\frac{416.2}{2422.3} \times 100 =$	17.2	$51.3 - 17.2 =$	34.1		34
1.18 (No. 16)	274.2	$\frac{274.2}{2422.3} \times 100 =$	11.3	$34.1 - 11.3 =$	22.8		23
0.600 (No. 30)	152.1	$\frac{152.1}{2422.3} \times 100 =$	6.3	$22.8 - 6.3 =$	16.5		17
0.300 (No. 50)	107.1	$\frac{107.1}{2422.3} \times 100 =$	4.4	$16.5 - 4.4 =$	12.1		12
0.150 (No. 100)	96.4	$\frac{96.4}{2422.3} \times 100 =$	4.0	$12.1 - 4.0 =$	8.1		8
0.075 (No. 200)	63.5	$\frac{63.5}{2422.3} \times 100 =$	2.6	$8.1 - 2.6 =$	5.5	-0.6 (5.5 - 0.6 =)	4.9
minus 75 μ m (No. 200) in the pan	5.7						
Total mass after sieving = sum of sieves + mass in the pan = 2295.3 g							
Dry mass of total sample, before washing (M_{T30}): 2422.3g							

* Report total percent passing to 1 percent except report the 75 μ m (No. 200) sieve to 0.1 percent.

ASPHALT

WAQTC

FOP AASHTO T 30 (22)

**Cumulative
Gradation on All Sieves**

Sieve Size mm (in.)	Cumulative Mass Retained g (CMR)	Determine CPR by dividing CMR by M and multiplying by 100	Cumulative Percent Retained (CPR)	Determine PP by subtracting CPR from 100.0	Percent Passing (PP)	Agg. Corr. Factor from T 308 (ACF)	Reported Percent Passing*
19.0 (3/4)	0		0.0		100.0		100
12.5 (1/2)	346.9	$\frac{346.9}{2422.3} \times 100 =$	14.3	$100.0 - 14.3 =$	85.7		86
9.5 (3/8)	554.7	$\frac{554.7}{2422.3} \times 100 =$	22.9	$100.0 - 22.9 =$	77.1		77
4.75 (No. 4)	1180.1	$\frac{1180.1}{2422.3} \times 100 =$	48.7	$100.0 - 48.7 =$	51.3		51
2.36 (No. 8)	1596.3	$\frac{1596.3}{2422.3} \times 100 =$	65.9	$100.0 - 65.9 =$	34.1		34
1.18 (No. 16)	1870.5	$\frac{1870.5}{2422.3} \times 100 =$	77.2	$100.0 - 77.2 =$	22.8		23
0.600 (No. 30)	2022.6	$\frac{2022.6}{2422.3} \times 100 =$	83.5	$100.0 - 83.5 =$	16.5		17
0.300 (No. 50)	2129.7	$\frac{2129.7}{2422.3} \times 100 =$	87.9	$100.0 - 87.9 =$	12.1		12
0.150 (No. 100)	2226.1	$\frac{2226.1}{2422.3} \times 100 =$	91.9	$100.0 - 91.9 =$	8.1		8
0.075 (No. 200)	2289.6	$\frac{2289.6}{2422.3} \times 100 =$	94.5	$100.0 - 94.5 =$	5.5	-0.6 (5.5 - 0.6 =)	4.9
minus 75 µm (No. 200) in the pan	2295.3						
Total mass after sieving = 2295.3 g							
Dry mass of total sample, before washing (M_{T30}): 2422.3g							

* Report total percent passing to 1 percent except report the 75 µm (No. 200) sieve to 0.1 percent.

ASPHALT

WAQTC

FOP AASHTO T 30 (22)

Report

- On forms approved by the agency
- Sample ID
- Depending on the agency, this may include:
 - Individual mass retained on each sieve
 - Individual percent retained on each sieve
 - Cumulative mass retained on each sieve
 - Cumulative percent retained on each sieve
 - Aggregate Correction Factor for each sieve from AASHTO T 308
 - Calculated percent passing each sieve to 0.1 percent
- Percent passing to the nearest 1 percent, except 75 μm (No. 200) sieve to the nearest 0.1 percent.

ANNEX A TIME EVALUATION

(Mandatory Information)

The minimum time requirement should be evaluated for each shaker at least annually by the following method:

1. Shake the sample over nested sieves for approximately 10 minutes.
2. Provide a snug-fitting pan and cover for each sieve and hold in a slightly inclined position in one hand.
3. Hand-shake each sieve by striking the side of the sieve sharply and with an upward motion against the heel of the other hand at the rate of about 150 times per minute, turning the sieve about one sixth of a revolution at intervals of about 25 strokes.

If more than 0.5 percent by mass of the total sample before sieving passes any sieve after one minute of continuous hand sieving adjust shaker time and re-check.

In determining sieving time for sieve sizes larger than 4.75 mm (No. 4), limit the material on the sieve to a single layer of particles.

ANNEX B OVERLOAD DETERMINATION

(Mandatory Information)

- For sieves with openings smaller than 4.75 mm (No. 4), the mass retained on any sieve shall not exceed 7 kg/m² (4 g/in²) of sieving surface.
- For sieves with openings 4.75 mm (No. 4) and larger, the mass (in kg) shall not exceed the product of 2.5 x (sieve opening in mm) x (effective sieving area). See Table B1.

Additional sieves may be necessary to keep from overloading the specified sieves. The sample may also be sieved in increments or sieves with a larger surface area.

TABLE B1
Maximum Allowable Mass of Material Retained on a Sieve, g
Nominal Sieve Size, mm (in.)
Exact size is smaller (see AASHTO T 27)

Sieve Size		203 mm	254 mm	305 mm
mm (in.)		(8 in.)	(10 in.)	(12 in.)
		dia.	dia.	dia.
		Sieving Area m ² (in ²)		
		0.0285	0.0457	0.0670
		(44.2)	(70.8)	(103.5)
50	(2)	3600	5700	8400
37.5	(1 1/2)	2700	4300	6300
25.0	(1)	1800	2900	4200
19.0	(3/4)	1400	2200	3200
16.0	(5/8)	1100	1800	2700
12.5	(1/2)	890	1400	2100
9.5	(3/8)	670	1100	1600
6.3	(1/4)	440	720	1100
4.75	(No. 4)	330	540	800
-4.75	(-No. 4)	200	320	470

ASPHALT

WAQTC

FOP AASHTO T 30 (22)

52_T30_short_22_errata

Asphalt 20-12

Pub. October 2022

ASPHALT

WAQTC

FOP AASHTO T 30 (17)

PERFORMANCE EXAM CHECKLIST

**MECHANICAL ANALYSIS OF EXTRACTED AGGREGATE
FOP FOR AASHTO T 30**

Participant Name _____ Exam Date _____

Record the symbols “P” for passing or “F” for failing on each step of the checklist.

Procedure Element	Trial 1	Trial 2
1. Total dry mass determined to 0.1 g	_____	_____
2. Dry mass agrees with sample mass after ignition (M _f) from AASHTO T 308 within 0.10 percent?	_____	_____
3. Sample placed in container and covered with water?	_____	_____
4. Wetting agent added?	_____	_____
5. Contents of container agitated vigorously?	_____	_____
6. Wash water poured through proper nest of two sieves?	_____	_____
7. Washing continued until wash water is clear and no wetting agent remaining?	_____	_____
8. Retained material returned to washed sample?	_____	_____
9. Washed material coarser than 75 µm (No. 200) dried to constant mass at 110 ±5°C (230 ±9°F)?	_____	_____
10. Sample cooled to room temperature?	_____	_____
11. Dry mass after washing determined to 0.1 g?	_____	_____
12. Material sieved on specified sieves?	_____	_____
13. Mass of each fraction of aggregate, including minus 75 µm (No. 200), determined and recorded to 0.1 g?	_____	_____
14. Total mass of material after sieving agrees with mass before sieving to within 0.2 percent?	_____	_____
15. Percent passing each sieve determined correctly to the nearest 0.1 percent?	_____	_____
16. Aggregate correction factor applied, if applicable?	_____	_____
17. Percent passing on each sieve reported correctly to the nearest 1 percent and nearest 0.1 percent on the 75 µm (No. 200)?	_____	_____

Comments: First attempt: Pass _____ Fail _____ Second attempt: Pass _____ Fail _____

Examiner Signature _____ WAQTC #: _____

ASPHALT

WAQTC

FOP AASHTO T 30 (17)

WSDOT Errata to FOP for AASHTO R 47

Reducing Samples of Asphalt Mixtures to Testing Size

WAQTC FOP for AASHTO R 47 has been adopted by WSDOT with the following changes:

Apparatus

Include items below:

- Mechanical Splitter Type A (Quartermaster): having four equal-width chutes discharging into four appropriately sized sample receptacles. Splitter is to be equipped with a receiving hopper that will hold the sample until the release lever is activated with four sample receptacles of sufficient capacity to accommodate the reduced portion of the Asphalt Mixture sample from the mechanical splitter. Refer to AASHTO R 47, Figures 1 through 3, for configuration and required dimensions of the mechanical splitter.

Selection of Procedure (Method)

Include items below:

- **Mechanical Splitter Method**
 - Type A (Quartermaster)
 - Type B (Riffle Splitter)

Procedure

Include items below:

Mechanical Splitter Type A (Quartermaster)

Note: This method is to be used for Initial Reduction of Field Sample ONLY.

1. Clean the splitter and apply a light coating of approved release agent to the surfaces that will contact Asphalt Mixture.
2. Close and secure hopper gates.
3. Place the four sample receptacles in the splitter so that there is no loss of material.
4. Remove the sample from the agency-approved container(s) and place in the mechanical splitter hopper. Avoid segregation, loss of Asphalt Mixture or the accidental addition of foreign material.
5. Release the handle, allowing the Asphalt Mixture to drop through the divider chutes and discharge into the four receptacles.
6. Any Asphalt Mixture that is retained on the surface of the splitter shall be removed and placed into the appropriate receptacle.
7. Close and secure the hopper gates.
8. Reduce the remaining Asphalt Mixture as needed by this method or a combination of the following methods as approved by the agency.

9. Combine the material contained in the receptacles from opposite corners and repeat the splitting process until an appropriate sample size is obtained.
10. Retain and properly identify the remaining unused portion of the HMA sample for further testing if required by the agency.

Quartering Method

Note: If this method is being used for Initial Reduction of Field Sample, step 4 “turning the entire sample over a minimum of 4 times” for safety reasons is not required.

Procedure

Include items below:

Sample Identification

1. Each sample submitted for testing shall be accompanied by a transmittal letter completed in detail. Include the contract number, acceptance and mix design verification numbers, mix ID.
2. Samples shall be submitted in standard sample boxes, secured to prevent contamination and spillage.
3. Sample boxes shall have the following information inscribed with indelible-type marker: Contract number, acceptance and mix design verification numbers, mix ID.
4. The exact disposition of each quarter of the original field sample shall be determined by the agency.

REDUCING SAMPLES OF ASPHALT MIXTURES TO TESTING SIZE FOP FOR AASHTO R 47

Scope

This procedure covers sample reduction of asphalt mixtures to testing size in accordance with AASHTO R 47-19. The reduced portion is to be representative of the original sample.

Apparatus

- Thermostatically controlled oven capable of maintaining a temperature of at least 110°C (230°F) or high enough to heat the material to a pliable condition for splitting.
- Non-contact temperature measuring device.
- Metal spatulas, trowels, metal straightedges, drywall taping knives, or a combination thereof; for removing asphalt mixture samples from the quartering device, cleaning surfaces used for splitting, etc.
- Square-tipped, flat-bottom scoop, shovel, or trowel for mixing asphalt mixture before quartering.
- Miscellaneous equipment including hot plate, non-asbestos heat-resistant gloves or mittens, pans, buckets, and cans.
- Sheeting: Non-stick heavy paper or other material as approved by the agency.
- Agency-approved release agent, free of solvent or petroleum-based material that could affect asphalt binder.
- Mechanical Splitter Type B (Riffle): having a minimum of eight equal-width chutes discharging alternately to each side with a minimum chute width of at least 50 percent larger than the largest particle size. A hopper or straight-edged pan with a width equal to or slightly smaller than the assembly of chutes in the riffle splitter to permit uniform discharge of the asphalt mixture through the chutes without segregation or loss of material. Sample receptacles of sufficient width and capacity to receive the reduced portions of asphalt mixture from the splitter without loss of material.
- Quartering Template: formed in the shape of a cross with equal length sides at right angles to each other. Template shall be manufactured of metal that will withstand heat and use without deforming. The sides of the quartering template should be sized so that the length exceeds the diameter of the flattened cone of asphalt mixture by an amount allowing complete separation of the quartered sample. Height of the sides must exceed the thickness of the flattened cone of asphalt mixture.
- Non-stick mixing surface that is hard, heat-resistant, clean, level, and large enough to permit asphalt mixture samples to be mixed without contamination or loss of material.

Sampling

Obtain samples according to the FOP for AASHTO R 97.

Sample Preparation

The sample must be warm enough to separate. If not, warm in an oven until it is sufficiently soft to mix and separate easily. Do not exceed either the temperature or time limits specified in the test method(s) to be performed.

Selection of Procedure (Method)

Refer to agency requirements when determining the appropriate method(s) of sample reduction. In general, the selection of a particular method to reduce a sample depends on the initial size of the sample vs. the size of the sample needed for the specific test to be performed. It is recommended that, for large amounts of material, the initial reduction be performed using a mechanical splitter. This decreases the time needed for reduction and minimizes temperature loss. Further reduction of the remaining asphalt mixture may be performed by a combination of the following methods, as approved by the agency.

The methods for reduction are:

- Mechanical Splitter Type B (Riffle) Method
- Quartering Method
 - Full Quartering
 - By Apex
- Incremental Method

Procedure

When heating of the equipment is desired, it shall be heated to a temperature not to exceed the maximum mixing temperature of the job mix formula (JMF).

Mechanical Splitter Type B (Riffle) Method

1. Clean the splitter and apply a light coating of approved release agent to the surfaces that will come in contact with asphalt mixture (hopper or straight-edged pan, chutes, receptacles).
2. Place two empty receptacles under the splitter.
3. Carefully empty the asphalt mixture from the agency-approved container(s) into the hopper or straight-edged pan without loss of material. Uniformly distribute from side to side of the hopper or pan.
4. Discharge the asphalt mixture at a uniform rate, allowing it to flow freely through the chutes.
5. Any asphalt mixture that is retained on the surface of the splitter shall be removed and placed into the appropriate receptacle.
6. Reduce the remaining asphalt mixture as needed by this method or a combination of the following methods as approved by the agency.

7. Using one of the two receptacles containing asphalt mixture, repeat the reduction process until the asphalt mixture contained in one of the two receptacles is the appropriate size for the required test.
8. After each split, remember to clean the splitter hopper and chute surfaces if needed.
9. Retain and properly identify the remaining unused asphalt mixture sample for further testing if required by the agency.

Quartering Method

1. If needed, apply a light coating of release agent to quartering template.
2. Dump the sample from the agency approved container(s) into a conical pile on a hard, “non-stick,” clean, level surface where there will be neither a loss of material nor the accidental addition of foreign material. The surface can be made non-stick by the application of an approved asphalt release agent, or sheeting.
3. Mix the material thoroughly by turning the entire sample over a minimum of four times with a flat-bottom scoop; or by alternately lifting each corner of the sheeting and pulling it over the sample diagonally toward the opposite corner, causing the material to be rolled. Create a conical pile by either depositing each scoop or shovelful of the last turning on top of the preceding one or lifting both opposite corners.
4. Flatten the conical pile to a uniform diameter and thickness where the diameter is four to eight times the thickness. Make a visual observation to ensure that the material is homogeneous.
5. Divide the flattened cone into four equal quarters using the quartering template or straightedges assuring complete separation.
6. Reduce to appropriate sample mass by full quartering or by apex.

Full Quartering

- a. Remove diagonally opposite quarters, including all of the fine material, and place in a container to be retained.
- b. Remove the quartering template, if used.
- c. Combine the remaining quarters.
- d. If further reduction is necessary, repeat Quartering Method Steps 3 through 6.
- e. Repeat until appropriate sample mass is obtained. The final sample must consist of the two remaining diagonally opposite quarters.
- f. Retain and properly identify the remaining unused portion of the asphalt mixture sample for further testing if required by the agency.

Reducing by Apex

- a. Using a straightedge, slice through a quarter of the asphalt mixture from the center point to the outer edge of the quarter.
- b. Pull or drag the material from the quarter with two straight edges or hold one edge of the straightedge in contact with quartering device.
- c. Remove an equal portion from the diagonally opposite quarter and combine these increments to create the appropriate sample mass.
- d. Continue using the apex method with the unused portion of the asphalt mixture until samples have been obtained for all required tests.
- e. Retain and properly identify the remaining unused portion of the asphalt mixture sample for further testing if required by the agency.

Incremental Method

1. Cover a hard, clean, level surface with sheeting. This surface shall be large enough that there will be neither a loss of material nor the accidental addition of foreign material.
2. Place the sample from the agency approved container(s) into a conical pile on that surface.
3. Mix the material thoroughly by turning the entire sample over a minimum of four times:
 - a. Use a flat-bottom scoop; or
 - b. Alternately lift each corner of the sheeting and pull it over the sample diagonally toward the opposite corner, causing the material to be rolled.
4. Create a conical pile by either depositing each scoop or shovelful of the last turning on top of the preceding one or lifting both opposite corners.
5. Grasp the sheeting and roll the conical pile into a cylinder (loaf), then flatten the top. Make a visual observation to determine that the material is homogenous.
6. Remove one quarter of the length of the loaf and place in a container to be saved by either:
 - a. Pull sheeting over edge of counter and drop material into container.
 - b. Use a straightedge at least as wide as the full loaf to slice off material and place into container.
7. Obtain an appropriate sample mass for the test to be performed; by either:
 - a. Pull sheeting over edge of counter and drop cross sections of the material into container until proper sample mass has been obtained.
 - b. Use a straightedge at least as wide as the full loaf to slice off cross sections of the material until proper sample mass has been obtained and place into container.

Note 1: When reducing the sample to test size it is advisable to take several small increments, determining the mass each time until the proper minimum size is achieved. Unless the sample size is grossly in excess of the minimum or exceeds the maximum test size, use the sample as reduced for the test.

ASPHALT

WAQTC

FOP AASHTO R 47 (19)

8. Repeat Step 7 until all the samples for testing have been obtained or until final quarter of the original loaf is reached.
9. Retain and properly identify the remaining unused portion of the asphalt mixture sample for further testing if required by the agency.

ASPHALT

WAQTC

FOP AASHTO R 47 (19)

ASPHALT

WAQTC

FOP AASHTO R 47 (19)

PERFORMANCE EXAM CHECKLIST**REDUCING SAMPLES OF ASPHALT MIXTURES TO TESTING SIZE
FOP FOR AASHTO R 47**

Participant Name _____ Exam Date _____

Record the symbols "P" for passing or "F" for failing on each step of the checklist.

Procedure Element	Trial 1	Trial 2
1. Sample made soft enough to separate easily without exceeding temperature limits?	_____	_____
2. Splitting apparatus and tools, if preheated, not exceeding maximum mixing temperature from the JMF?	_____	_____
Mechanical Splitter Type B (Riffle) Method		
1. Splitter cleaned, and surfaces coated with release agent?	_____	_____
2. Two empty receptacles placed under splitter?	_____	_____
3. Sample placed in hopper or straight edged pan without loss of material and uniformly distributed from side to side?	_____	_____
4. Material discharged across chute assembly at controlled rate allowing free flow of asphalt mixture through chutes?	_____	_____
5. Splitter surfaces cleaned of all retained asphalt mixture allowing it to fall into appropriate receptacles?	_____	_____
6. Further reduction with the riffle splitter:		
a. Material from one receptacle discharged across chute assembly at controlled rate, allowing free flow of asphalt mixture through chutes?	_____	_____
b. Splitting process continued until appropriate sample mass obtained, with splitter surfaces cleaned of all retained asphalt mixture after every split?	_____	_____
7. Remaining unused asphalt mixture stored in suitable container, properly labeled?	_____	_____

OVER

Procedure Element	Trial 1	Trial 2
Quartering Method		
1. Sample placed in a conical pile on a hard, non-stick, heat-resistant splitting surface such as metal or sheeting?	_____	_____
2. Sample mixed by turning the entire sample over a minimum of 4 times?	_____	_____
3. Conical pile formed and then flattened uniformly to diameter equal to about 4 to 8 times thickness?	_____	_____
4. Sample divided into 4 equal portions either with a metal quartering template or straightedges such as drywall taping knives?	_____	_____
5. Reduction by Full Quartering:		
a. Two diagonally opposite quarters removed and placed in a container to be retained?	_____	_____
b. Two other diagonally opposite quarters combined?	_____	_____
c. Process continued, if necessary, until appropriate sample mass has been achieved?	_____	_____
6. Reduction by Apex:		
a. Using two straightedges or a quartering device and one straightedge, one of the quarters split from apex to outer edge of material?	_____	_____
b. Similar amount of material taken from the diagonally opposite quarter?	_____	_____
c. Increments combined to produce appropriate sample mass?	_____	_____
7. Remaining unused asphalt mixture stored in suitable container, properly labeled?	_____	_____

OVER

ASPHALT

WAQTC

FOP AASHTO R 47 (19)

Procedure Element

Trial 1 Trial 2

Incremental Method

- | | | |
|--|-------|-------|
| 1. Sample placed on hard, non-stick, heat-resistant splitting surface covered with sheeting? | _____ | _____ |
| 2. Sample mixed by turning the entire sample over a minimum of 4 times? | _____ | _____ |
| 3. Conical pile formed? | _____ | _____ |
| 4. Asphalt mixture rolled into loaf and then flattened? | _____ | _____ |
| 5. The first quarter of the loaf removed by slicing off or dropping off edge of counter and set aside? | _____ | _____ |
| 6. Proper sample mass sliced off or dropped off edge of counter into sample container? | _____ | _____ |
| 7. Process continued until all samples are obtained or final quarter is remaining? | _____ | _____ |
| 8. All remaining unused asphalt mixture stored in suitable container, properly labeled? | _____ | _____ |

Comments: First attempt: Pass_____Fail_____ Second attempt: Pass_____Fail_____

Examiner Signature _____ **WAQTC #:** _____

ASPHALT

WAQTC

FOP AASHTO R 47 (19)

WSDOT Errata to FOP for AASHTO R 66

Sampling Asphalt Materials

WAQTC FOP for AASHTO R 66 has been adopted by WSDOT with the following changes:

Containers

Include sentence below:

Emulsified asphalt: Use wide-mouth plastic jars with screw caps. Protect the samples from freezing since water is a part of the emulsion. The sample container should be completely filled to minimize a skin formation on the sample. Place tape around the seam of the cap to keep the cap from loosening and spilling the contents.

SAMPLING ASPHALT MATERIALS FOP FOR AASHTO R 66

Scope

This procedure covers obtaining samples of liquid asphalt materials in accordance with AASHTO R 66-16. Sampling of solid and semi-solid asphalt materials – included in AASHTO R 66 – is not covered here.

Agencies may be more specific on exactly who samples, where to sample, and what type of sampling device to use.

Warning: Always use appropriate safety equipment and precautions for hot liquids.

Terminology

- Asphalt binder: Asphalt cement or modified asphalt cement that binds the aggregate particles into a dense mass.
- Asphalt emulsion: A mixture of asphalt binder and water.
- Cutback asphalt: Asphalt binder that has been modified by blending with a chemical solvent.

Containers

Sample containers must be new, and the inside may not be washed or rinsed. The outside may be wiped with a clean, dry cloth.

All samples shall be put in 1 L (1 qt) containers and properly identified on the outside of the container with contract number, date sampled, data sheet number, brand and grade of material, and sample number. Include lot and subplot numbers when appropriate.

- Emulsified asphalt: Use wide-mouth plastic jars with screw caps. Protect the samples from freezing since water is a part of the emulsion. The sample container should be completely filled to minimize a skin formation on the sample.
- Asphalt binder and cutbacks: Use metal cans

Note: The sample container shall not be submerged in solvent, nor shall it be wiped with a solvent saturated cloth. If cleaning is necessary, use a clean dry cloth.

Procedure

1. Coordinate sampling with contractor or supplier.
2. Allow a minimum of 4 L (1 gal) to flow before obtaining samples.
3. Obtain samples of:
 - Asphalt binder from the line between the storage tank and the mixing plant while the plant is in operation, or from the delivery truck.
 - Cutback and emulsified asphalt from distributor spray bar or application device; or from the delivery truck before it is pumped into the distributor. Sample emulsified asphalt at delivery or before dilution.

Report

- On standard agency forms
- Sample ID
- Date
- Time
- Location
- Quantity represented

DEVELOPING A FAMILY OF CURVES FOP FOR AASHTO R 75

Scope

This procedure provides a method to develop a family of curves in accordance with AASHTO R 75-16 using multiple moisture density relationships developed using the same method, A, B, C, or D, from the FOP for AASHTO T 99/T 180.

All curves used in a family must be developed using a single Method: A, B, C, or D of a procedure for AASHTO T 99 or T 180. See the FOP for AASHTO T 99/T 180.

Terminology

family of curves — a group of soil moisture-density relationships (curves) determined using AASHTO T 99 or T 180, which reveal certain similarities and trends characteristic of the soil type and source.

spine — smooth line extending through the point of maximum density/optimum moisture content of a family of moisture-density curves.

Procedure

1. Sort the curves by Method (A, B, C, or D of the FOP for T 99/T 180). At least three curves are required to develop a family.
2. Select the highest and lowest maximum dry densities from those selected to assist in determining the desired scale of the subsequent graph.
3. Plot the maximum density and optimum moisture points of the selected curves on the graph.
4. Draw a smooth, “best fit,” curved line through the points creating the spine of the family of curves.
5. Remove maximum density and optimum moisture points that were not used to establish the spine.
6. Add the moisture/density curves associated with the points that were used to establish the spine. It is not necessary to include the portion of the curves over optimum moisture.

Note 1—Intermediate template curves using slopes similar to those of the original moisture-density curves may be included when maximum density points are more than 2.0 lb/ft³ apart. Template curves are indicated by a dashed line.

7. Plot the 80 percent of optimum moisture range when desired:
 - a. Using the optimum moisture of an existing curve, calculate 80 percent of optimum moisture and plot this value on the curve. Repeat for each curve in the family.
 - b. Draw a smooth, “best fit,” curved line connecting the 80 percent of optimum moisture points plotted on the curves that parallel the spine.

Calculations

Calculate 80 percent of optimum moisture of each curve:

Example:

Optimum moisture of the highest density curve = 14.6%

$$80\% \text{ point} = \frac{80}{100} \times 14.6\% = 11.7\%$$

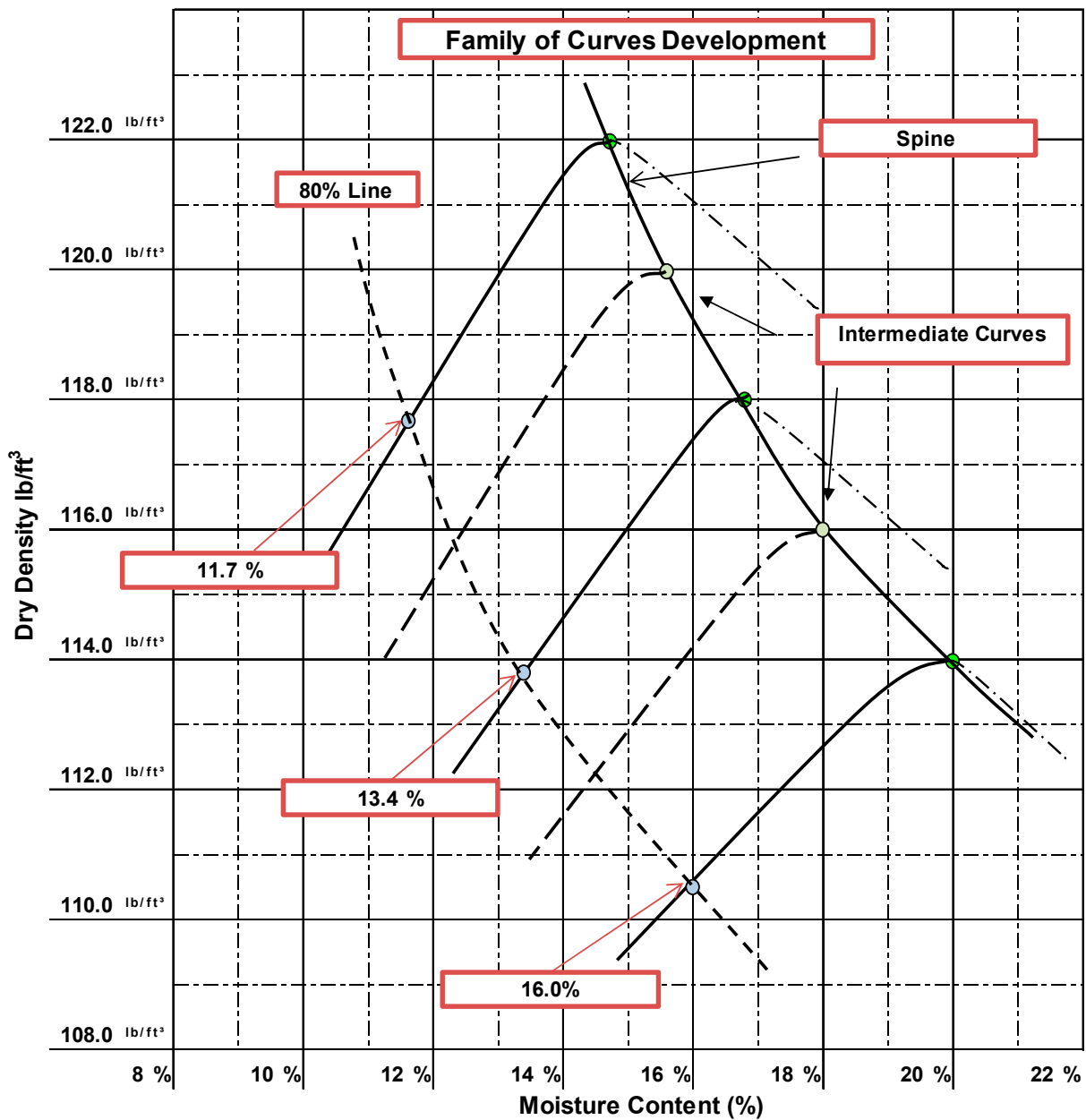

EMBANKMENT AND BASE
IN-PLACE DENSITY

WAQTC

FOP AASHTO R 75 (18)

PERFORMANCE EXAM CHECKLIST

**DEVELOPING A FAMILY OF CURVES
FOP FOR AASHTO R 75**

Participant Name _____ Exam Date _____

Record the symbols "P" for passing or "F" for failing on each step of the checklist.

Procedure Element	Trial 1	Trial 2
1. Curves sorted by method and procedure (A, B, C, or D of the FOP for T 99/T 180)?	_____	_____
a. At least three curves per family?	_____	_____
b. Curves within family are similar soil type and from same source?	_____	_____
2. Maximum density and optimum moisture points plotted on the graph?	_____	_____
3. Spine drawn correctly?	_____	_____
4. Maximum density and optimum moisture points removed that were not used for the spine?	_____	_____
5. Moisture/density curves added?	_____	_____
6. Optimum moisture range?	_____	_____
a. 80 percent of optimum moisture calculated for each curve?	_____	_____
b. Curved line through 80 percent of optimum moisture drawn correctly?	_____	_____

Comments: First attempt: Pass____Fail____ Second attempt: Pass____Fail____

Examiner Signature _____ WAQTC #: _____

EMBANKMENT AND BASE
IN-PLACE DENSITY

WAQTC

FOP AASHTO R 75 (18)

WSDOT Errata to FOP for AASHTO R 76

Reducing Samples of Aggregate to Testing Size

WAQTC FOP for AASHTO R 76 has been adopted by WSDOT with the following changes:

Procedure

Method A – Mechanical Splitter

Mechanical Splitter Check - *Step not required by WSDOT*

REDUCING SAMPLES OF AGGREGATE TO TESTING SIZE FOP FOR AASHTO R 76

Scope

This procedure covers the reduction of samples to the appropriate size for testing in accordance with AASHTO R 76-16. Techniques are used that minimize variations in characteristics between test samples and field samples. Method A (Mechanical Splitter) and Method B (Quartering) are covered.

This FOP applies to fine aggregate (FA), coarse aggregate (CA), and mixes of the two (FA / CA) and may also be used on soils.

Apparatus

Method A – Mechanical Splitter

Splitter chutes:

- Even number of equal width chutes
- Discharge alternately to each side
- Minimum of 8 chutes total for CA and FA / CA, 12 chutes total for FA
- Width:
 - Minimum 50 percent larger than largest particle
 - Maximum chute width of 19 mm (3/4 in.) for fine aggregate passing the 9.5 mm (3/8 in.) sieve

Feed control:

- Hopper or straightedge pan with a width equal to or slightly less than the overall width of the assembly of chutes
- Capable of feeding the splitter at a controlled rate

Splitter receptacles / pans:

- Capable of holding two halves of the sample following splitting

The splitter and accessory equipment shall be so designed that the sample will flow smoothly without restriction or loss of material.

Method B – Quartering

- Straightedge scoop, shovel, or trowel
- Broom or brush
- Tarp: A square canvas or plastic sheet, appropriate for the amount and size of the material being reduced

Method Selection

Samples of CA may be reduced by either Method A or Method B.

Samples of FA which are drier than the saturated surface dry (SSD) condition, as described in AASHTO T 84, shall be reduced by a mechanical splitter according to Method A. As a quick approximation, if the fine aggregate will retain its shape when molded with the hand, it is wetter than SSD.

Samples of FA / CA which are drier than SSD may be reduced by Method A or Method B.

Samples of FA and FA / CA that are at SSD or wetter than SSD shall be reduced by Method B, or the entire sample may be dried – using temperatures that do not exceed those specified for any of the tests contemplated – and then reduced to test sample size using Method A.

Table 1

	Drier than SSD	Wetter than SSD
Fine Aggregate (FA)	Method A (Mechanical)	Method B (Quartering)
Mixture of FA/CA	Either Method	Method B (Quartering)
Coarse Aggregate (CA)	Either Method	Either Method

Procedure

Method A – Mechanical Splitter

1. Place two clean empty receptacles under the splitter.
2. Empty the sample into the hopper or pan without loss of material.
3. Uniformly distribute the material in the hopper or pan from edge to edge so that approximately equal amounts flow through each chute.
4. Discharge the material at a uniform rate, allowing it to flow freely through the chutes.
5. Remove any material retained on the surface of the splitter and place into the appropriate receptacle.
6. Using one of the two receptacles containing material, repeat Steps 1 through 6 until the material in one of the two receptacles is the appropriate sample size for the required test.
7. Retain and properly identify the remaining unused sample for further testing if required.

Mechanical Splitter Check

- Determine the mass of each reduced portion. If the percent difference of the two masses is greater than 5 percent, corrective action must be taken.

Calculation

$$\frac{\text{Smaller Mass}}{\text{Larger Mass}} = \text{Ratio} \quad (1 - \text{ratio}) \times 100 = \% \text{ Difference}$$

Splitter check: 5127 g total sample mass

Splitter pan #1: 2583 g

Splitter pan #2: 2544 g

$$\frac{2544 \text{ g}}{2583 \text{ g}} = 0.985 \quad (1 - 0.985) \times 100 = 1.5\%$$

Alternative to Mechanical Splitter Check

- In lieu of determining the mass of each reduced portion, use the method illustrated in Figure 1 or 2 during reduction.

Figure 1

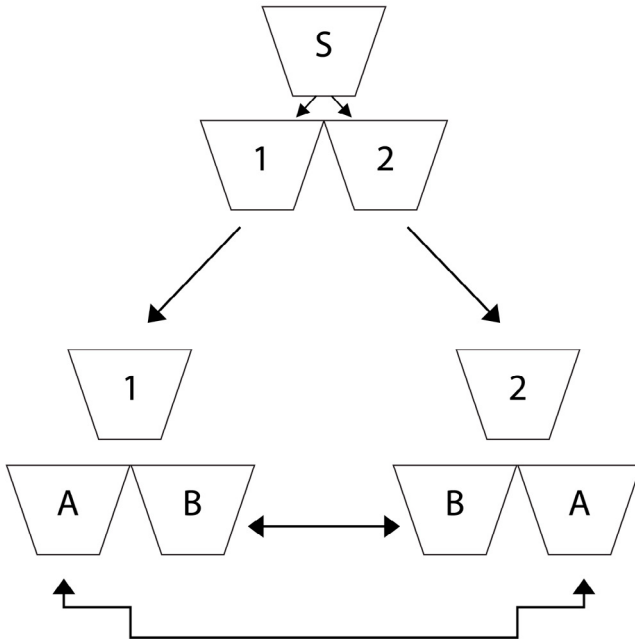

- Sample (S) is an amount greater than or equal to twice the mass needed for testing. Sample (S) is reduced in a mechanical splitter to yield parts (1) and (2).
- Part (1) is further reduced yielding (A) and (B) while part (2) is reduced to yield (B) and (A).
- Final testing sample is produced by combining alternate pans, i.e. A/A or B/B only.

Figure 2

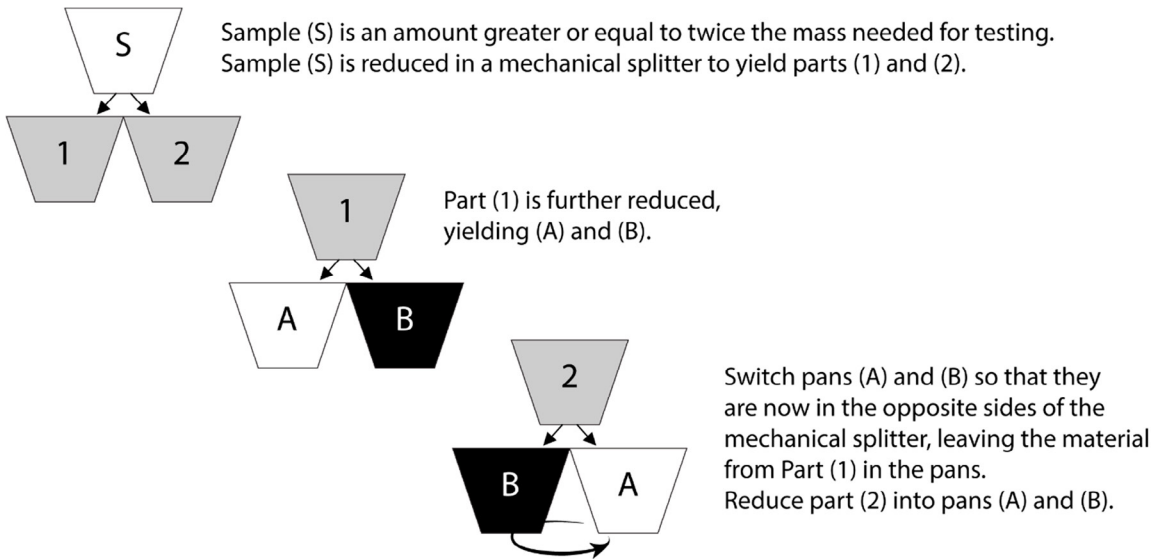

Method B – Quartering

Use either of the following two procedures or a combination of both.

Procedure 1: Quartering on a clean, hard, level surface:

1. Place the sample on a hard, clean, level surface where there will be neither loss of material nor the accidental addition of foreign material.
2. Mix the material thoroughly by turning the entire sample over a minimum of four times. With the last turning, shovel the entire sample into a conical pile by depositing each shovelful on top of the preceding one.
3. Flatten the conical pile to a uniform thickness and diameter by pressing down with a shovel. The diameter should be four to eight times the thickness.
4. Divide the flattened pile into four approximately equal quarters with a shovel or trowel.
5. Remove two diagonally opposite quarters, including all fine material, and brush the cleared spaces clean.
6. Successively mix and quarter the remaining material until the sample is reduced to the desired size.
7. The final test sample consists of two diagonally opposite quarters.

Procedure 2: Quartering on a tarp:

1. Place the sample on the tarp.
2. Mix the material thoroughly a minimum of four times by pulling each corner of the tarp horizontally over the sample toward the opposite corner. After the last turn, form a conical pile.
3. Flatten the conical pile to a uniform thickness and diameter by pressing down with a shovel. The diameter should be four to eight times the thickness.
4. Divide the flattened pile into four approximately equal quarters with a shovel or trowel or insert a stick or pipe beneath the tarp and under the center of the pile, then lift both ends of the stick, dividing the sample into two roughly equal parts. Remove the stick leaving a fold of the tarp between the divided portions. Insert the stick under the center of the pile at right angles to the first division and again lift both ends of the stick, dividing the sample into four roughly equal quarters.
5. Remove two diagonally opposite quarters, being careful to clean the fines from the tarp.

AGGREGATE

WAQTC

FOP AASHTO R 76 (20)

6. Successively mix and quarter the remaining material until the sample size is reduced to the desired size.
7. The final test sample consists of two diagonally opposite quarters.

PERFORMANCE EXAM CHECKLIST

**REDUCING SAMPLES OF AGGREGATE TO TESTING SIZE
FOP FOR AASHTO R 76**

Participant Name _____ Exam Date _____

Record the symbols "P" for passing or "F" for failing on each step of the checklist.

Trial 1 Trial 2

Method A - Splitting

- 1. Chutes appropriate size and number? _____
- 2. Material spread uniformly on feeder? _____
- 3. Rate of feed slow enough so that sample flows freely through chutes? _____
- 4. Material in one pan re-split until desired mass is obtained? _____
- 5. Mechanical splitter checked or alternative used? _____

Method B - Quartering

- 1. Sample placed on a tarp or clean, hard, and level surface? _____
- 2. Mixed by turning over 4 times with shovel or by pulling the tarp horizontally over pile? _____
- 3. Conical pile formed without loss of material? _____
- 4. Pile flattened to uniform thickness and diameter? _____
- 5. Diameter equal to about 4 to 8 times thickness? _____
- 6. Divided into 4 equal portions without loss of material?
 - a. Using a shovel or trowel? _____
 - b. Placing stick or pipe under the tarp? _____
- 7. Two diagonally opposite quarters, including all fine material, removed? _____
- 8. Process continued until desired sample size is obtained when two opposite quarters combined? _____

Comments: First attempt: Pass _____ Fail _____ Second attempt: Pass _____ Fail _____

Examiner Signature _____ **WAQTC #:** _____

VACUUM DRYING COMPACTED ASPHALT SPECIMENS FOP FOR AASHTO R 79

Scope

This practice covers the process of drying compacted field and laboratory specimens using a vacuum device in accordance with AASHTO R 79-19.

Overview

The specimens dried by this procedure remain near room temperature, which helps in maintaining specimen integrity during the drying process and allows the operators to run repeated tests on the same sample, if necessary.

Specimens are kept and stored at temperatures above 15°C (60°F) and below 54°C (130°F).

This practice can also be used for drying other construction materials such as concrete, soils, aggregates, and loose asphalt mixtures. Use manufacturer's recommendations for drying other construction materials.

Apparatus

- Vacuum device:
 - Attached to a pump capable of evacuating a sealed chamber to a pressure of 1 kPa (6 mm Hg) when at sea level.
 - Capable of controlling the vacuum, airflow, and temperature in order to properly dry the specimen at close to room temperature.
 - With a display that indicates a pressure value, the dry point in the chamber, and number of cycles.
 - With a plate for removing water from the bottom surface of the specimen chamber.
 - With means to trap moisture that is removed from the sample.
- Chamber (attached to the vacuum device): Large enough to hold cylindrical specimens, 150 mm (6 in.) diameter by 180 mm (7 in.) height, or cubical samples, 150 mm (6 in.) length by 150 mm (6 in.) width by 180 mm (7 in.) height.
- Thermometric device or infrared thermometer: accurate to $\pm 5^{\circ}\text{C}$ ($\pm 9^{\circ}\text{F}$).
- Balance or scale: Capacity sufficient for the sample mass and conforming to the requirements of M 231, Class G2.

Daily Equipment Preparation

1. Dry the moisture trap (if necessary) and the specimen (vacuum) chamber.
2. Run the device without any specimens. The device should display a pressure value that indicates a known dry point.

Note 1: If the unit fails to achieve a dry point pressure value, as recommended by the manufacturer, check that the lid and all hose connections are well sealed. If needed, refer to the manufacturer's troubleshooting instructions.

Test Specimens

Test specimens may be either laboratory-molded or sampled from asphalt mixture pavement.

Procedure

Note 2: Keeping the device in the off position when not in use can prolong the operating life of its components.

1. Measure the sample temperature with a handheld infrared thermometer. Make sure the specimen surface temperature is above 15°C (60°F).
2. Remove any standing water from the surface of the specimen by using a paper towel or an absorptive cloth.
3. Place the specimen inside the vacuum chamber, closing the lid to the vacuum chamber and moisture trap (if applicable).
4. Initiate the vacuum drying cycle. The pressure is monitored throughout the drying cycle to ensure dry specimen condition pressure is achieved in the device.
5. The device will automatically stop when the specimen is dry.

Note 3: The device is calibrated at the factory or by the operator according to manufacturer's recommended procedures to sense a dry specimen condition.

6. Remove the specimen from the chamber.
7. Determine and record the specimen mass to the nearest 0.1 g.
8. Repeat steps 5 through 7 until specimen weight after vacuum drying cycle is less than 0.3 g from previous drying cycle.

Note 4: Between drying cycles, wipe off any free-standing water in the moisture trap to speed up the specimen drying cycles.

Note 5: Excessive temperature may damage the specimen. Between drying cycles, verify that the specimen temperature has not exceeded 54°C (130°F).

Performance Exam Checklist

Vacuum Drying Compacted Asphalt Specimens

FOP FOR AASHTO R 79

Participant Name _____ Exam Date _____

Record the symbols "P" for passing or "F" for failing on each step of the checklist.

Procedure Element	Trial 1	Trial 2
1. The tester has a copy of the current procedure on hand? All equipment is functioning according to the test procedure, and if required, has the	_____	_____
2. current calibration/standardization/check tags present?	_____	_____
3. Device specimen chamber and moisture trap dry?	_____	_____
4. Device ran without any specimens and indicates a known dry point?	_____	_____
5. Specimen surface temperature above 60°F (15°C)?	_____	_____
6. Specimen surfaced dried and placed inside vacuum chamber?	_____	_____
7. Vacuum drying cycle initiated after closing chamber and moisture trap lids?	_____	_____
8. Specimen removed from chamber and mass determined after drying cycle complete?	_____	_____
9. Steps repeated until specimen mass is less than 0.3 g from previous drying cycle mass?	_____	_____
10. Free-standing water in moisture trap wiped off between cycles?	_____	_____

First Attempt: Pass Fail Second Attempt: Pass Fail

Signature of Examiner _____ WAQTC # _____

Comments:

SPECIFIC GRAVITY AND ABSORPTION OF COARSE AGGREGATE FOP FOR AASHTO T 85

Scope

This procedure covers the determination of specific gravity and absorption of coarse aggregate in accordance with AASHTO T 85-22. Specific gravity may be expressed as bulk specific gravity (G_{sb}), bulk specific gravity, saturated surface dry (G_{sb} SSD), or apparent specific gravity (G_{sa}). G_{sb} and absorption are based on aggregate after soaking in water. This procedure is not intended to be used with lightweight aggregates.

Terminology

Absorption – the increase in the mass of aggregate due to water being absorbed into the pores of the material, but not including water adhering to the outside surface of the particles, expressed as a percentage of the dry mass. The aggregate is considered “dry” when it has been maintained at a temperature of $110 \pm 5^\circ\text{C}$ ($230 \pm 9^\circ\text{F}$) for sufficient time to remove all uncombined water.

Saturated Surface Dry (SSD) – condition of an aggregate particle when the permeable voids are filled with water, but no water is present on exposed surfaces.

Specific Gravity – the ratio of the mass, in air, of a volume of a material to the mass of the same volume of gas-free distilled water at a stated temperature.

Apparent Specific Gravity (G_{sa}) – the ratio of the mass, in air, of a volume of the impermeable portion of aggregate to the mass of an equal volume of gas-free distilled water at a stated temperature.

Bulk Specific Gravity (G_{sb}) – the ratio of the mass, in air, of a volume of aggregate (including the permeable and impermeable voids in the particles, but not including the voids between particles) to the mass of an equal volume of gas-free distilled water at a stated temperature.

Bulk Specific Gravity (SSD) (G_{sb} SSD) – the ratio of the mass, in air, of a volume of aggregate, including the mass of water within the voids filled to the extent achieved by submerging in water for 15 to 19 hours (but not including the voids between particles), to the mass of an equal volume of gas-free distilled water at a stated temperature.

Apparatus

- Balance or scale: with a capacity of 5 kg, sensitive to 0.1 g. Meeting the requirements of AASHTO M 231.
- Sample container: a wire basket of 3.35 mm (No. 6) or smaller mesh, with a capacity of 4 to 7 L (1 to 2 gal) to contain aggregate with a nominal maximum size of 37.5 mm (1 1/2 in.) or smaller; or a larger basket for larger aggregates, or both.
- Water tank: watertight and large enough to completely immerse aggregate and basket, equipped with an overflow valve to keep water level constant.

- Suspension apparatus: wire used to suspend apparatus shall be of the smallest practical diameter.
- Sieves: 4.75 mm (No. 4) or other sizes as needed, meeting the requirements of FOP for AASHTO T 27/T 11.
- Large absorbent towel

Sample Preparation

1. Obtain the sample in accordance with the FOP for AASHTO R 90 (see Note 1).
2. Mix the sample thoroughly and reduce it to the approximate sample size required by Table 1 in accordance with the FOP for AASHTO R 76.
3. Reject all material passing the appropriate sieve by dry sieving.
4. Thoroughly wash sample to remove dust or other coatings from the surface.
5. Dry the test sample to constant mass according to the FOP for AASHTO T 255/T 265 at a temperature of $110 \pm 5^{\circ}\text{C}$ ($230 \pm 9^{\circ}\text{F}$) and cool in air at room temperature for 1 to 3 hours.

Note 1: Where the absorption and specific gravity values are to be used in proportioning concrete mixtures in which the aggregates will be in their naturally moist condition, the requirement for initial drying to constant mass may be eliminated, and, if the surfaces of the particles in the sample have been kept continuously wet until test, the 15-to-19 hour soaking may also be eliminated.

6. Re-screen the sample over the appropriate sieve. Reject all material passing that sieve.
7. The sample shall meet or exceed the minimum mass given in Table 1.

Note 2: If this procedure is used only to determine the G_{sb} of oversized material for the FOP for AASHTO T 99 / T 180, the material can be rejected over the appropriate sieve. For T 99 / T 180 Methods A and B, use the 4.75 mm (No. 4) sieve; T 99 / T 180 Methods C and D use the 19 mm (3/4 in).

Table 1

Nominal Maximum Size* mm (in.)	Minimum Mass of Test Sample, g (lb)
12.5 (1/2) or less	2000 (4.4)
19.0 (3/4)	3000 (6.6)
25.0 (1)	4000 (8.8)
37.5 (1 1/2)	5000 (11)
50 (2)	8000 (18)
63 (2 1/2)	12,000 (26)
75 (3)	18,000 (40)

* One sieve larger than the first sieve to retain more than 10 percent of the material using an agency specified set of sieves based on cumulative percent retained. Where large gaps in specification sieves exist, intermediate sieve(s) may be inserted to determine nominal maximum size.

Procedure

1. Immerse the aggregate in water at room temperature for a period of 15 to 19 hours.

Note 3: When testing coarse aggregate of large nominal maximum size requiring large test samples, it may be more convenient to perform the test on two or more subsamples, and then combine the values obtained.

2. Place the empty basket into the water bath and attach to the balance. Inspect the immersion tank to ensure the water level is at the overflow outlet height and basket is fully submerged. Tare the balance with the empty basket attached in the water bath.
3. Remove the test sample from the water and roll it in a large absorbent cloth until all visible films of water are removed. Wipe the larger particles individually. If the test sample dries past the SSD condition, immerse in water for 30 min, and then resume the process of surface-drying.

Note 4: A moving stream of air may be used to assist in the drying operation but take care to avoid evaporation of water from aggregate pores.

4. Determine the SSD mass of the sample, and record this and all subsequent masses to the nearest 0.1 g or 0.1 percent of the sample mass, whichever is greater. Designate this mass as "B."
5. Immediately place the SSD test sample in the sample container and weigh it in water maintained at $23.0 \pm 1.7^{\circ}\text{C}$ ($73.4 \pm 3^{\circ}\text{F}$). Shake the container to release entrapped air before recording the weight. Re-inspect the immersion tank to ensure the water level is at the overflow outlet height and basket is fully submerged. Designate this submerged weight as "C."

Note 5: The container should be immersed to a depth sufficient to cover it and the test sample during mass determination. Wire suspending the container should be of the smallest practical size to minimize any possible effects of a variable immersed length.

6. Remove the sample from the basket. Ensure all material has been removed. Place in a container of known mass.
7. Dry the test sample to constant mass according to the FOP for AASHTO T 255 / T 265 at $110 \pm 5^{\circ}\text{C}$ ($230 \pm 9^{\circ}\text{F}$) and cool in air at room temperature for 1 to 3 hours.
8. Determine and record the dry mass. Designate this mass as "A."

Calculations

Perform calculations and determine values using the appropriate formula below.

Bulk specific gravity (G_{sb})

$$G_{sb} = \frac{A}{B - C}$$

Bulk specific gravity, SSD ($G_{sb} SSD$)

$$G_{sb}SSD = \frac{B}{B - C}$$

Apparent specific gravity (G_{sa})

$$G_{sa} = \frac{A}{A - C}$$

Absorption

$$\text{Absorption} = \frac{B - A}{A} \times 100$$

Where:

- A = oven dry mass, g
- B = SSD mass, g
- C = weight in water, g

Sample Calculations

Sample	A	B	C	B - C	A - C	B - A
1	2030.9	2044.9	1304.3	740.6	726.6	14.0
2	1820.0	1832.5	1168.1	664.4	651.9	12.5
3	2035.2	2049.4	1303.9	745.5	731.3	14.2

Sample	G_{sb}	G_{sb} SSD	G_{sa}	Absorption
1	2.742	2.761	2.795	0.7
2	2.739	2.758	2.792	0.7
3	2.730	2.749	2.783	0.7

These calculations demonstrate the relationship between G_{sb} , G_{sb} SSD, and G_{sa} . G_{sb} is always lowest since the volume includes voids permeable to water. G_{sb} SSD is always intermediate. G_{sa} is always highest since the volume does not include voids permeable to water. When running this test, check to make sure the values calculated make sense in relation to one another.

Report

- On forms approved by the agency
- Sample ID
- Specific gravity values to the nearest 0.001
- Absorption to the nearest 0.1 percent

EMBANKMENT AND BASE
IN-PLACE DENSITY

WAQTC

FOP AASHTO T 85 (22)

EMBANKMENT AND BASE
IN-PLACE DENSITY

WAQTC

FOP AASHTO T 85 (18)

PERFORMANCE EXAM CHECKLIST

SPECIFIC GRAVITY AND ABSORPTION OF COARSE AGGREGATE FOP FOR AASHTO T 85

Participant Name _____ Exam Date _____

Record the symbols "P" for passing or "F" for failing on each step of the checklist.

Procedure Element	Trial 1	Trial 2
1. Sample obtained by FOP for AASHTO R 90 and reduced by FOP for AASHTO R 76 or from FOP for AASHTO T 99 / T 180?	_____	_____
2. Screened on the appropriate size sieve?	_____	_____
3. Sample mass appropriate?	_____	_____
4. Particle surfaces clean?	_____	_____
5. Dried to constant mass $110 \pm 5^{\circ}\text{C}$ ($230 \pm 9^{\circ}\text{F}$) and cooled to room temperature?	_____	_____
6. Re-screen over appropriate sieve?	_____	_____
7. Covered with water for 15 to 19 hours?	_____	_____
8. Wire basket completely submerged in immersion tank and attached to balance?	_____	_____
9. Immersion tank inspected for proper water height?	_____	_____
10. Balance tared with basket in tank and temperature checked $23.0 \pm 1.7^{\circ}\text{C}$ ($73.4 \pm 3^{\circ}\text{F}$)?	_____	_____
11. Sample removed from water and rolled in cloth to remove visible films of water?	_____	_____
12. Larger particles wiped individually?	_____	_____
13. Evaporation avoided?	_____	_____
14. Sample mass determined to 0.1 g?	_____	_____
15. Sample immediately placed in basket, in immersion tank?	_____	_____
16. Entrapped air removed before weighing by shaking basket while immersed?	_____	_____
17. Immersion tank inspected for proper water height?	_____	_____
18. Immersed sample weight determined to 0.1 g?	_____	_____
19. All the sample removed from basket?	_____	_____
20. Sample dried to constant mass and cooled to room temperature?	_____	_____

OVER

EMBANKMENT AND BASE
IN-PLACE DENSITY

WAQTC

FOP AASHTO T 85 (18)

Procedure Element

Trial 1 Trial 2

21. Sample mass determined to 0.1 g?

22. Proper formulas used in calculations?

Comments: First attempt: Pass _____ Fail _____ Second attempt: Pass _____ Fail _____

Examiner Signature _____ WAQTC #: _____

WSDOT Errata to FOP for AASHTO R 90

Sampling Aggregate Products

WAQTC FOP for AASHTO R 90 has been adopted by WSDOT with the following changes:

Procedure – General

TABLE 1 Recommended Sample Sizes – *Shall conform to the following table, nominal maximum size definition and note.*

Nominal Maximum Size*in (mm)		Minimum Mass lb (kg)	
US No. 4	(4.75)	5	(2)
¼	(6.3)	10	(4)
⅜	(9.5)	10	(4)
½	(12.5)	20	(8)
⅝	(16.0)	20	(8)
¾	(19.0)	30	(12)
1	(25.0)	55	(25)
1¼	(31.5)	70	(30)
1½	(37.5)	80	(36)
2	(50)	90	(40)
2½	(63)	110	(50)
3	(75)	140	(60)
3½	(90)	180	(80)

*For Aggregate, the nominal maximum size sieve is the largest standard sieve opening listed in the applicable specification upon which more than 1-percent of the material by weight is permitted to be retained. For concrete aggregate, the nominal maximum size sieve is the smallest standard sieve opening through which the entire amount of aggregate is permitted to pass.

Note: For an aggregate specification having a generally unrestrictive gradation (i.e., wide range of permissible upper sizes), where the source consistently fully passes a screen substantially smaller than the maximum specified size, the nominal maximum size, for the purpose of defining sampling and test specimen size requirements may be adjusted to the screen, found by experience to retain no more than 5 percent of the materials.

Procedure – Specific Situations

Roadways

Method A (Berm or Windrow) – *Method not recognized by WSDOT.*

Method B (In-Place) – *Method not recognized by WSDOT.*

SAMPLING AGGREGATE PRODUCTS FOP FOR AASHTO R 90

Scope

This procedure covers sampling of coarse, fine, or a combination of coarse and fine aggregates (CA and FA) in accordance with AASHTO R 90-18. Sampling from conveyor belts, transport units, roadways, and stockpiles is covered.

Apparatus

- Shovels or scoops, or both
- Brooms, brushes, and scraping tools
- Sampling tubes of acceptable dimensions
- Mechanical sampling systems: normally a permanently attached device that allows a sample container to pass perpendicularly through the entire stream of material or diverts the entire stream of material into the container by manual, hydraulic, or pneumatic operation
- Belt template
- Sampling containers

Procedure – General

Sampling is as important as testing. The technician shall use every precaution to obtain samples that are representative of the material. Determine the time or location for sampling in a random manner.

1. Wherever samples are taken, obtain multiple increments of approximately equal size.
2. Mix the increments thoroughly to form a field sample that meets or exceeds the minimum mass recommended in Table 1.

TABLE 1
Recommended Sample Sizes

Nominal Maximum Size*	Minimum Mass
mm (in.)	g (lb)
90 (3 1/2)	175,000 (385)
75 (3)	150,000 (330)
63 (2 1/2)	125,000 (275)
50 (2)	100,000 (220)
37.5 (1 1/2)	75,000 (165)
25.0 (1)	50,000 (110)
19.0 (3/4)	25,000 (55)
12.5 (1/2)	15,000 (35)
9.5 (3/8)	10,000 (25)
4.75 (No. 4)	10,000 (25)
2.36 (No. 8)	10,000 (25)

* One sieve larger than the first sieve to retain more than 10 percent of the material using an agency specified set of sieves based on cumulative percent retained. Where large gaps in specification sieves exist, intermediate sieve(s) may be inserted to determine nominal maximum size. Maximum size is one size larger than nominal maximum size.

Note 1: Sample size is based upon the test(s) required. As a general rule, the field sample size should be such that, when split twice will provide a testing sample of proper size. For example, the sample size may be four times that shown in Table 1 of the FOP for AASHTO T 27/T 11, if that mass is more appropriate.

Procedure – Specific Situations

Conveyor Belts

Avoid sampling at the beginning or end of the aggregate run due to the potential for segregation. Be careful when sampling in the rain. Make sure to capture fines that may stick to the belt or that the rain tends to wash away.

Method A (From the Belt)

1. Stop the belt.
2. Set the sampling template in place on the belt, avoiding intrusion by adjacent material.
3. Remove the material from inside the template, including all fines.
4. Obtain at least three approximately equal increments.
5. Combine the increments and mix thoroughly to form a single sample.

Method B (From the Belt Discharge)

1. Pass a sampling device through the full stream of the material as it runs off the end of the conveyor belt. The sampling device may be manually, semi-automatic or automatically powered.
2. The sampling device shall pass through the stream at least twice, once in each direction, without overfilling while maintaining a constant speed during the sampling process.
3. When emptying the sampling device into the container, include all fines.
4. Combine the increments to form a single sample.

Transport Units

1. Visually divide the unit into four quadrants.
2. Identify one sampling location in each quadrant.
3. Dig down and remove approximately 0.3 m (1 ft.) of material to avoid surface segregation. Obtain each increment from below this level.
4. Combine the increments and mix thoroughly to form a single sample.

Roadways**Method A (Berm or Windrow)**

1. Obtain sample before spreading.
2. Take the increments from at least three random locations along the fully formed windrow or berm. Do not take the increments from the beginning or the end of the windrow or berm.
3. Obtain full cross-section samples of approximately equal size at each location. Take care to exclude the underlying material.
4. Combine the increments and mix thoroughly to form a single sample.

Note 2: Obtaining samples from berms or windrows may yield extra-large samples and may not be the preferred sampling location.

Method B (In-Place)

1. Obtain sample after spreading and before compaction.
2. Take the increments from at least three random locations.
3. Obtain full-depth increments of approximately equal size from each location. Take care to exclude the underlying material.
4. Combine the increments and mix thoroughly to form a single sample.

Stockpiles

Method A – Loader Sampling

1. Direct the loader operator to enter the stockpile with the bucket at least 150 mm (6 in.) above ground level without contaminating the stockpile.
2. Discard the first bucketful.
3. Have the loader re-enter the stockpile and obtain a full loader bucket of the material, tilt the bucket back and up.
4. Form a small sampling pile at the base of the stockpile by gently rolling the material out of the bucket with the bucket just high enough to permit free flow of the material. (Repeat as necessary.)
5. Create a flat surface by having the loader back drag the small pile.
6. Visually divide the flat surface into four quadrants.
7. Collect an increment from each quadrant by fully inserting the shovel into the flat pile as vertically as possible, take care to exclude the underlying material, roll back the shovel and lift the material slowly out of the pile to avoid material rolling off the shovel.
8. Combine the increments and mix thoroughly to form a single sample.

Method B – Stockpile Face Sampling

1. Create horizontal surfaces with vertical faces in the top, middle, and bottom third of the stockpile with a shovel or loader.
2. Prevent continued sloughing by shoving a flat board against the vertical face. Sloughed material will be discarded to create the horizontal surface.
3. Obtain sample from the horizontal surface as close to the intersection as possible of the horizontal and vertical faces.
4. Obtain at least one increment of equal size from each of the top, middle, and bottom thirds of the pile.
5. Combine the increments to and mix thoroughly form a single sample.

Method C – Alternate Tube Method (Fine Aggregate)

1. Remove the outer layer that may have become segregated.
2. Using a sampling tube, obtain one increment of equal size from a minimum of five random locations on the pile.
3. Combine the increments to and mix thoroughly form a single sample.

Identification and Shipping

- Identify samples according to agency standards.
- Include sample report (below).
- Ship samples in containers that will prevent loss, contamination, or damage of material.

Report

- On forms approved by the agency
- Date
- Time
- Sample ID
- Sampling method
- Location
- Quantity represented
- Material type
- Supplier

AGGREGATE

WAQTC

FOP AASHTO R 90 (22)

37_R90_short_22_errata

Aggregate 9-6

Pub. October 2022

PERFORMANCE EXAM CHECKLIST

**SAMPLING AGGREGATE PRODUCTS
FOP FOR AASHTO R 90**

Participant Name _____ Exam Date _____

Record the symbols “P” for passing or “F” for failing on each step of the checklist.

Procedure Element	Trial 1	Trial 2
Conveyor Belts – Method A (From the Belt)		
1. Belt stopped?	_____	_____
2. Sampling template set on belt, avoiding intrusion of adjacent material?	_____	_____
3. Sample, including all fines, scooped off?	_____	_____
4. Samples taken in at least three approximately equal increments?	_____	_____
5. Increments combined and mixed to form a single sample?	_____	_____
Conveyor Belts – Method B (From the Belt Discharge)		
6. Sampling device passed through full stream of material twice (once in each direction) as it runs off end of belt?	_____	_____
7. Increments combined and mixed to form a single sample?	_____	_____
Transport Units		
8. Unit divided into four quadrants?	_____	_____
9. Increment obtained from each quadrant, 0.3 m (1ft.) below surface?	_____	_____
10. Increments combined and mixed to form a single sample?	_____	_____
Roadways Method A (Berm or Windrow)		
11. Sample taken before spreading?	_____	_____
12. Full depth of material taken?	_____	_____
13. Underlying material excluded?	_____	_____
14. Samples taken in at least three approximately equal increments?	_____	_____
15. Increments combined and mixed to form a single sample?	_____	_____

OVER

AGGREGATE

WAQTC

FOP AASHTO R 90 (22)

Roadways Method B (In-place)

- 16. Sample taken after spreading? _____
- 17. Full depth of material taken? _____
- 18. Underlying material excluded? _____
- 19. Samples taken in at least three approximately equal increments? _____
- 20. Increments combined and mixed to form a single sample? _____

Stockpile Method A– (Loader sampling)

- 21. Loader operator directed to enter the stockpile with the bucket at least 150 mm (6 in.) above ground level without contaminating the stockpile? _____
- 22. First bucketful discarded? _____
- 23. The loader re-entered the stockpile and obtained a full loader bucket of the material with the bucket tilted back and up? _____
- 24. A small sampling pile formed at the base of the stockpile by gently rolling the material out of the bucket with the bucket just high enough to permit free-flow of the material? _____
- 25. A flat surface created by the loader back dragging the small pile? _____
- 26. Increment sampled from each quadrant by fully inserting the shovel into the flat pile as vertically as possible, care taken to exclude the underlying material? _____
- 27. Increments combined and mixed to form a single sample? _____

Stockpile Method B (Stockpile Face)

- 28. Created horizontal surfaces with vertical faces? _____
- 29. At least one increment taken from each of the top, middle, and bottom thirds of the stockpile. _____
- 30. Increments combined and mixed to form a single sample? _____

Stockpile Method C – Alternate Tube Method (Fine Aggregate)

- 31. Outer layer removed? _____
- 32. Increments taken from at least five locations with a sampling tube? _____
- 33. Increments combined and mixed to form a single sample? _____

Comments: First attempt: Pass ___ Fail ___ Second attempt: Pass ___ Fail ___

Examiner Signature _____ WAQTC #: _____

PERFORMANCE EXAM CHECKLIST (ORAL)**SAMPLING AGGREGATE PRODUCTS
FOP FOR AASHTO R 90**

Participant Name _____ Exam Date _____

Record the symbols "P" for passing or "F" for failing on each step of the checklist.

Procedure Element	Trial 1	Trial 2
1. How is a sample obtained from a conveyor belt using Method A?		
a. Stop the belt.	_____	_____
b. Set the sampling template on belt, avoiding intrusion of adjacent material.	_____	_____
c. All the material is removed from belt including all fines.	_____	_____
d. Take at least three approximately equal increments.	_____	_____
e. Combine and mix to form a single sample.	_____	_____
2. How is a sample obtained from a conveyor belt using Method B?		
a. Pass the sampling device through a full stream of material as it runs off the end of the belt.	_____	_____
b. The device must be passed through at least twice (once in each direction).	_____	_____
c. Increments combined and mixed to form a single sample?	_____	_____
d. Combine and mix to form a single sample.	_____	_____
3. How is a sample obtained from a Transport Unit?		
a. Divide the unit into four quadrants.	_____	_____
b. Dig 0.3 m (1 ft.) below surface.	_____	_____
c. Obtain an increment from each quadrant.	_____	_____
d. Combine and mix to form a single sample.	_____	_____
4. Describe the procedure for sampling from roadways Method A (Berm or Windrow).		
a. Sample before spreading	_____	_____
b. Sample the material full depth without obtaining underlying material.	_____	_____
c. Take at least three approximately equal increments.	_____	_____
d. Combine and mix to form a single sample.	_____	_____

OVER

Procedure Element

Trial 1 Trial 2

5. Describe the procedure for sampling from roadway Method B (In-place).

- a. Sample after spreading, before compaction. _____
- b. Sample the material full depth without obtaining underlying material. _____
- c. Take at least three approximately equal increments. _____
- d. Combine and mix to form a single sample. _____

6. Describe the procedure for sampling a stockpile Method A (Loader Sampling).

- a. Loader enters the stockpile at least 150 mm (6in.) above ground level. _____
- b. Loader discard first bucket full. _____
- c. Loader obtains a full bucket of material and forms a small sampling pile. _____
- d. Loader back drags pile to create a flat surface. _____
- e. Divide the flat surface into four quadrants. _____
- f. Take an approximately equal increment from each quadrant, excluding the underlying material. _____
- g. Combine and mix to form a single sample. _____

7. Describe the procedure for sampling a stockpile Method B (Stockpile Face Sampling).

- a. Create horizontal surfaces with vertical faces with a shovel. _____
- b. At least one increment taken from each of the top, middle, and bottom thirds of the stockpile. _____
- c. Combine and mix to form a single sample. _____

8. Describe the procedure for sampling a stockpile Method C – Alternate Tube Method (Fine Aggregate).

- a. Remove the outer layer of segregated material. _____
- b. Obtain increments using sampling tube from at least five locations. _____
- c. Combine and mix to form a single sample. _____

Comments: First attempt: Pass _____ Fail _____ Second attempt: Pass _____ Fail _____

Examiner Signature _____ WAQTC #: _____

WSDOT FOP for AASHTO T 90

Determining the Plastic Limit and Plasticity Index of Soils

WSDOT has adopted the published AASHTO T 90.

AASHTO Test Methods cannot be included in Materials Manual due to copyright infringement.

WSDOT employees can access AASHTO and ASTM test methods in the following web address:

<http://wwwi.wsdot.wa.gov/MatsLab/BusinessOperations/ASTMLogin.htm>

Non-WSDOT employees can order AASHTO's Standard Specifications for Transportation Materials and Methods of Sampling and Testing, using the following web address:

<https://store.transportation.org>

Performance Exam Checklist

AASHTO T 90

Determining the Plastic Limit and Plasticity Index of Soils

Participant Name _____ Exam Date _____

Preparation

Yes No

- | | | |
|--|-------|-------|
| 1. The tester has a copy of the current procedure on hand? | _____ | _____ |
| 2. All equipment is functioning according to the test procedure, and if required, has the current calibration/verification tags present? | _____ | _____ |
| 3. Sample obtained using AASHTO R 58? | _____ | _____ |
| 4. Minimum sample mass meets requirement of AASHTO T 90? | _____ | _____ |
| 5. Sample mixed with distilled, demineralized, or de-ionized water until plastic enough to be easily shaped into a ball? | _____ | _____ |
| 6. 10 g portion of ball taken from the moist sample material? | _____ | _____ |

Pocedure

Yes No

- | | | |
|--|-------|-------|
| 1. 1.5-2 g portion taken and formed into ellipsoidal mass? | _____ | _____ |
| 2. Mass rolled at between 80-90 strokes per minute (using one of the techniques described in T 90) for no more than 2 minutes to form a 3 mm diameter thread? | _____ | _____ |
| 3. Thread broken into six or eight pieces and pieces squeezed together into ellipsoidal shape and rerolled until thread crumbles and soil can no longer be rolled into a thread? | _____ | _____ |
| 4. Tested material placed in a tared covered container and procedure steps 1-6 repeated until all 10 g of material is tested? | _____ | _____ |
| 5. Sample dried in accordance with AASHTO T 265 to determine moisture content? | _____ | _____ |
| 6. Were all calculations performed correctly? | _____ | _____ |

First Attempt: Pass Fail Second Attempt: Pass Fail

Signature of Examiner _____ WAQTC #: _____

Comments:

WSDOT Errata to FOP for AASHTO T 99

Moisture-Density Relations of Soils

Using a 2.5 KG (5.5 LB) Rammer and a 305 MM (12 IN.) Drop

WAQTC FOP for AASHTO T 99 has been adopted by WSDOT with the following changes:

Scope

Replace with below:

This procedure covers the determination of the moisture-density relations of soils and soil-aggregate mixtures in accordance with two similar test methods:

AASHTO T 99-22: Methods A, B, C, and D

AASHTO T 180-22: Methods A, B, C, and D

This test method applies to soil mixtures having **30** percent or less retained on the 4.75 mm (No. 4) sieve for methods A or B, or, 30 percent or less retained on the 19 mm ($\frac{3}{4}$ in) with methods C or D. The retained material is defined as oversize (coarse) material. If no minimum percentage is specified, 5 percent will be used. Samples that contain oversize (coarse) material that meet percent retained criteria should be corrected by using *Annex A, Correction of Maximum Dry Density and Optimum Moisture for Oversized Particles*. Samples of soil or soil-aggregate mixture are prepared at several moisture contents and compacted into molds of specified size, using manual or mechanical rammers that deliver a specified quantity of compactive energy. The moist masses of the compacted samples are multiplied by the appropriate factor to determine wet density values. Moisture contents of the compacted samples are determined and used to obtain the dry density values of the same samples. Maximum dry density and optimum moisture content for the soil or soil-aggregate mixture is determined by plotting the relationship between dry density and moisture content.

**MOISTURE-DENSITY RELATIONS OF SOILS:
USING A 2.5 KG (5.5 LB) RAMMER AND A 305 MM (12 IN.) DROP**

**FOP FOR AASHTO T 99
USING A 4.54 KG (10 LB) RAMMER AND A 457 MM (18 IN.) DROP
FOP FOR AASHTO T 180**

Scope

This procedure covers the determination of the moisture-density relations of soils and soil-aggregate mixtures in accordance with two similar test methods:

- AASHTO T 99-22: Methods A, B, C, and D
- AASHTO T 180-22: Methods A, B, C, and D

This test method applies to soil mixtures having 40 percent or less retained on the 4.75 mm (No. 4) sieve for methods A or B, or 30 percent or less retained on the 19 mm ($\frac{3}{4}$ in.) sieve with methods C or D. The retained material is defined as oversize (coarse) material. If no minimum percentage is specified, 5 percent will be used. Samples that contain oversize (coarse) material that meet percent retained criteria should be corrected by using *Annex A, Correction of Maximum Dry Density and Optimum Moisture for Oversized Particles*. Samples of soil or soil-aggregate mixture are prepared at several moisture contents and compacted into molds of specified size, using manual or mechanical rammers that deliver a specified quantity of compactive energy. The moist masses of the compacted samples are multiplied by the appropriate factor to determine wet density values. Moisture contents of the compacted samples are determined and used to obtain the dry density values of the same samples. Maximum dry density and optimum moisture content for the soil or soil-aggregate mixture is determined by plotting the relationship between dry density and moisture content.

Apparatus

- Mold – Cylindrical mold made of metal with the dimensions shown in Table 1 or Table 2. If permitted by the agency, the mold may be of the “split” type, consisting of two half-round sections, which can be securely locked in place to form a cylinder. Determine the mold volume according to *Annex B, Standardization of the Mold*.
- Mold assembly – Mold, base plate, and a detachable collar.
- Rammer – Manually or mechanically operated rammers as detailed in Table 1 or Table 2. A manually operated rammer shall be equipped with a guide sleeve to control the path and height of drop. The guide sleeve shall have at least four vent holes no smaller than 9.5 mm ($\frac{3}{8}$ in.) in diameter, spaced approximately 90 degrees apart and approximately 19 mm ($\frac{3}{4}$ in.) from each end. A mechanically operated rammer will uniformly distribute blows over the sample and will be calibrated with several soil types, and be adjusted, if necessary, to give the same moisture-density results as with the manually operated rammer. For additional information concerning calibration, see AASHTO T 99 and T 180.

- Sample extruder – A jack, lever frame, or other device for extruding compacted specimens from the mold quickly and with little disturbance.
- Balance(s) or scale(s) of the capacity and sensitivity required for the procedure used by the agency.
 - A balance or scale with a capacity of 11.5 kg (25 lb) and a sensitivity of 1 g for obtaining the sample, meeting the requirements of AASHTO M 231, Class G 5.
 - A balance or scale with a capacity of 2 kg and a sensitivity of 0.1 g is used for moisture content determinations done under both procedures, meeting the requirements of AASHTO M 231, Class G 2.
- Drying apparatus – A thermostatically controlled drying oven, capable of maintaining a temperature of $110 \pm 5^{\circ}\text{C}$ ($230 \pm 9^{\circ}\text{F}$) for drying moisture content samples in accordance with the FOP for AASHTO T 255/T 265.
- Straightedge – A steel straightedge at least 250 mm (10 in.) long, with one beveled edge and at least one surface plane within 0.1 percent of its length, used for final trimming.
- Sieve(s) – 4.75 mm (No. 4) and/or 19.0 mm (3/4 in.), meeting the requirements of FOP for AASHTO T 27/T 11.
- Mixing tools – Miscellaneous tools such as a mixing pan, spoon, trowel, spatula, etc., or a suitable mechanical device, for mixing the sample with water.
- Containers with close-fitting lids to prevent gain or loss of moisture in the sample.

Table 1
Comparison of Apparatus, Sample, and Procedure – Metric

	T 99	T 180
Mold Volume, m ³	Methods A, C: 0.000943 ±0.000014	Methods A, C: 0.000943 ±0.000014
	Methods B, D: 0.002124 ±0.000025	Methods B, D: 0.002124 ±0.000025
Mold Diameter, mm	Methods A, C: 101.60 ±0.40	Methods A, C: 101.60 ±0.4
	Methods B, D: 152.40 ±0.70	Methods B, D: 152.40 ±0.70
Mold Height, mm	116.40 ±0.50	116.40 ±0.50
Detachable Collar Height, mm	50.80 ±0.64	50.80 ±0.64
Rammer Diameter, mm	50.80 ±0.25	50.80 ±0.25
Rammer Mass, kg	2.495 ±0.009	4.536 ±0.009
Rammer Drop, mm	305 ±2	457 ±2
Layers	3	5
Blows per Layer	Methods A, C: 25	Methods A, C: 25
	Methods B, D: 56	Methods B, D: 56
Material Size, mm	Methods A, B: 4.75 minus	Methods A, B: 4.75 minus
	Methods C, D: 19.0 minus	Methods C, D: 19.0 minus
Test Sample Size, kg	Method A: 3 Method C: 5 (1)	Method B: 7 Method D: 11(1)
Energy, kN-m/m ³	592	2,693

(1) This may not be a large enough sample depending on your nominal maximum size for moisture content samples.

Table 2
Comparison of Apparatus, Sample, and Procedure – English

	T 99	T 180
Mold Volume, ft ³	Methods A, C: 0.0333 ±0.0005	Methods A, C: 0.0333 ±0.0005
	Methods B, D: 0.07500 ±0.0009	Methods B, D: 0.07500 ±0.0009
Mold Diameter, in.	Methods A, C: 4.000 ±0.016	Methods A, C: 4.000 ±0.016
	Methods B, D: 6.000 ±0.026	Methods B, D: 6.000 ±0.026
Mold Height, in.	4.584 ±0.018	4.584 ±0.018
Detachable Collar Height, in.	2.000 ±0.025	2.000 ±0.025
Rammer Diameter, in.	2.000 ±0.025	2.000 ±0.025
Rammer Mass, lb	5.5 ±0.02	10 ±0.02
Rammer Drop, in.	12 ±0.06	18 ±0.06
Layers	3	5
Blows per Layer	Methods A, C: 25	Methods A, C: 25
	Methods B, D: 56	Methods B, D: 56
Material Size, in.	Methods A, B: No. 4 minus	Methods A, B: No.4 minus
	Methods C, D: 3/4 minus	Methods C, D: 3/4 minus
Test Sample Size, lb	Method A: 7 Method C: 12 ₍₁₎	Method B: 16 Method D: 25 ₍₁₎
Energy, lb-ft/ft ³	12,375	56,250

(1) This may not be a large enough sample depending on your nominal maximum size for moisture content samples.

Sample

If the sample is damp, dry it until it becomes friable under a trowel. Drying may be in air or by use of a drying apparatus maintained at a temperature not exceeding 60°C (140°F). Thoroughly break up aggregations in a manner that avoids reducing the natural size of individual particles.

Obtain a representative test sample of the mass required by the agency by passing the material through the sieve required by the agency. See Table 1 or Table 2 for test sample mass and material size requirements.

In instances where the material is prone to degradation, i.e., granular material, a compaction sample with differing moisture contents should be prepared for each point.

If the sample is plastic (clay types), it should stand for a minimum of 12 hours after the addition of water to allow the moisture to be absorbed. In this case, several samples at different moisture contents should be prepared, put in sealed containers, and tested the next day.

Note 1: Both T 99 and T 180 have four methods (A, B, C, D) that require different masses and employ different sieves.

Procedure

During compaction, rest the mold firmly on a dense, uniform, rigid, and stable foundation, or base. This base shall remain stationary during the compaction process.

1. Determine the mass of the clean, dry mold. Include the base plate but exclude the extension collar. Record the mass to the nearest 1 g (0.005 lb).
2. Thoroughly mix the selected representative sample with sufficient water to dampen it to approximately 4 to 8 percentage points below optimum moisture content. For many materials, this condition can be identified by forming a cast by hand.
 - a. Prepare individual samples of plastic or degradable material, increasing moisture contents 1 to 2 percent for each point.
 - b. Allow samples of plastic soil to stand for 12 hrs.
3. Form a specimen by compacting the prepared soil in the mold assembly in approximately equal layers. For each layer:
 - a. Spread the loose material uniformly in the mold.

Note 2: It is recommended to cover the remaining material with a non-absorbent sheet or damp cloth to minimize loss of moisture.

- b. Lightly tamp the loose material with the manual rammer or other similar device, this establishes a firm surface.
 - c. Compact each layer with uniformly distributed blows from the rammer. See Table 1 for mold size, number of layers, number of blows, and rammer specification for the various test methods. Use the method specified by the agency.
 - d. Trim down material that has not been compacted and remains adjacent to the walls of the mold and extends above the compacted surface.

4. Remove the extension collar. Avoid shearing off the sample below the top of the mold. The material compacted in the mold should not be over 6 mm (¼ in.) above the top of the mold once the collar has been removed.
5. Trim the compacted soil even with the top of the mold with the beveled side of the straightedge.
6. Clean soil from exterior of the mold and base plate.
7. Determine and record the mass of the mold, base plate, and wet soil to the nearest 1 g (0.005 lb).
8. Determine and record the wet mass (M_w) of the sample by subtracting the mass in Step 1 from the mass in Step 7.
9. Calculate the wet density (ρ_w), in kg/m^3 (lb/ft^3), by dividing the wet mass by the measured volume (V_m).
10. Extrude the material from the mold. For soils and soil-aggregate mixtures, slice vertically through the center and remove one of the cut faces for a representative moisture content sample. For granular materials, a vertical face will not exist. Take a representative sample ensuring that all layers are represented. This sample must meet the sample size requirements of the test method used to determine moisture content.

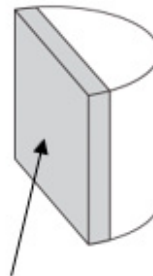
**Extruded material****Representative moisture
content sample**

Note 3: When developing a curve for free-draining soils such as uniform sands and gravels, where seepage occurs at the bottom of the mold and base plate, taking a representative moisture content from the mixing bowl may be preferred in order to determine the amount of moisture available for compaction.

11. Determine and record the moisture content (w) of the sample in accordance with the FOP for AASHTO T 255 / T 265.
12. If the material is degradable or plastic, return to Step 3 using a prepared individual sample. If not, continue with Steps 13 through 15.
13. Thoroughly break up the remaining portion of the molded specimen until it will again pass through the sieve, as judged by eye, and add to the remaining portion of the sample being tested.
14. Add sufficient water to increase the moisture content of the remaining soil by 1 to 2 percentage points and repeat steps 3 through 11.

15. Continue determinations until there is either a decrease or no change in the wet mass. There will be a minimum of three points on the dry side of the curve and two points on the wet side. For non-cohesive, drainable soils, one point on the wet side is sufficient.

Calculations

Wet Density

$$\rho_w = \frac{M_w}{V_m}$$

Where:

- ρ_w = wet density, kg/m³ (lb/ft³)
 M_w = wet mass
 V_m = volume of the mold, Annex B

Dry Density

$$\rho_d = \left(\frac{\rho_w}{w + 100} \right) \times 100 \quad \text{or} \quad \rho_d = \frac{\rho_w}{\left(\frac{w}{100} \right) + 1}$$

Where:

- ρ_d = dry density, kg/m³ (lb/ft³)
 w = moisture content, as a percentage

Example for 4-inch mold, Methods A or C

- Wet mass, M_w = 1.928 kg (4.25 lb)
 Moisture content, w = 11.3%
 Measured volume of the mold, V_m = 0.000946 m³ (0.0334 ft³)

Wet Density

$$\rho_w = \frac{1.928 \text{ kg}}{0.000946 \text{ m}^3} = 2038 \text{ kg/m}^3 \quad \rho_w = \frac{4.25 \text{ lb}}{0.0334 \text{ ft}^3} = 127.2 \text{ lb/ft}^3$$

Dry Density

$$\rho_d = \left(\frac{2038 \text{ kg/m}^3}{11.3 + 100} \right) \times 100 = 1831 \text{ kg/m}^3 \quad \rho_d = \left(\frac{127.2 \text{ lb/ft}^3}{11.3 + 100} \right) \times 100 = 114.3 \text{ lb/ft}^3$$

Or

$$\rho_d = \left(\frac{2038 \text{ kg/m}^3}{\frac{11.3}{100} + 1} \right) = 1831 \text{ kg/m}^3 \quad \rho_d = \left(\frac{127.2 \text{ lb/ft}^3}{\frac{11.3}{100} + 1} \right) = 114.3 \text{ lb/ft}^3$$

Moisture-Density Curve Development

When dry density is plotted on the vertical axis versus moisture content on the horizontal axis and the points are connected with a smooth line, a moisture-density curve is developed. The coordinates of the peak of the curve are the maximum dry density, or just “maximum density,” and the “optimum moisture content” of the soil.

Example

Given the following dry density and corresponding moisture content values develop a moisture-density relations curve and determine maximum dry density and optimum moisture content.

Dry Density		Moisture Content, %
kg/m ³	lb/ft ³	
1831	114.3	11.3
1853	115.7	12.1
1873	116.9	12.8
1869	116.7	13.6
1857	115.9	14.2

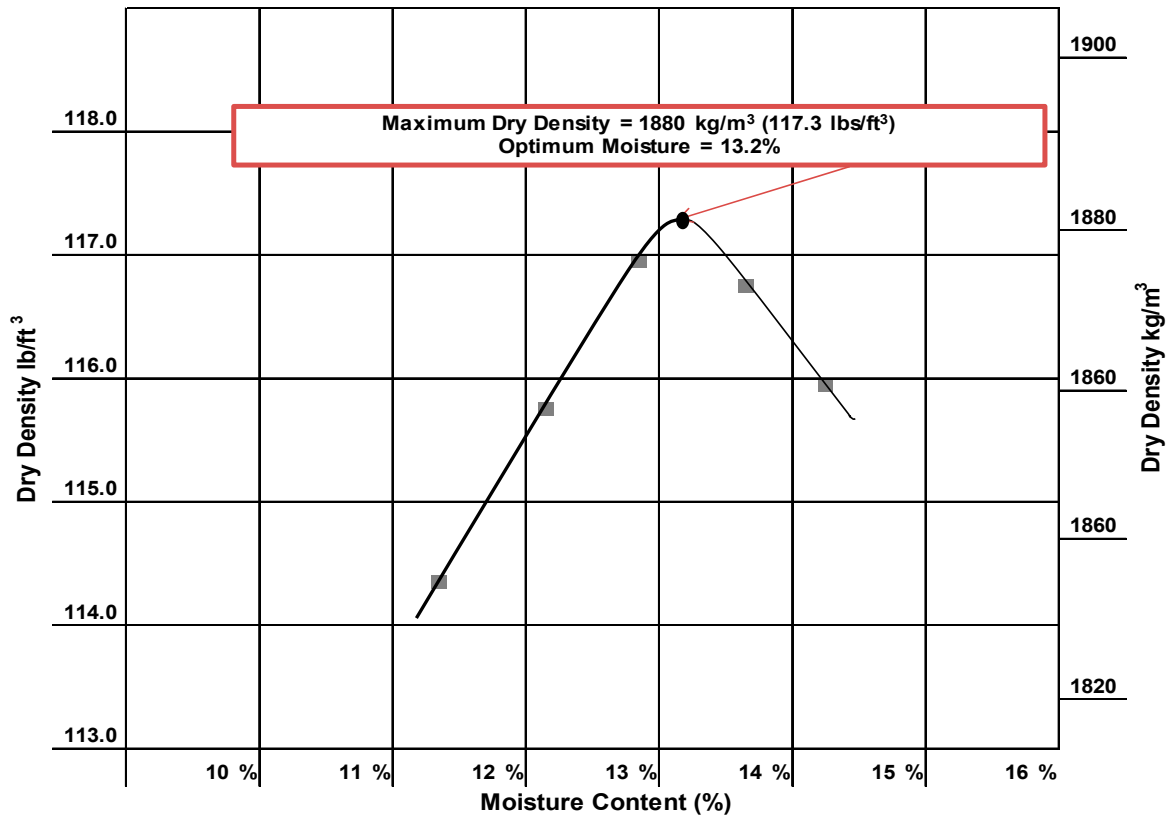

In this case, the curve has its peak at:

Maximum dry density = 1880 kg/m³ (117.3 lb/ft³)

Optimum moisture content = 13.2%

Note that both values are approximate since they are based on sketching the curve to fit the points.

Report

- Results on forms approved by the agency
- Sample ID
- Maximum dry density to the nearest 1 kg/m³ (0.1 lb/ft³)
- Optimum moisture content to the nearest 0.1 percent

ANNEX A**CORRECTION OF MAXIMUM DRY DENSITY AND OPTIMUM MOISTURE FOR
OVERSIZED PARTICLES**

(Mandatory Information)

This section corrects the maximum dry density and moisture content of the material retained on the 4.75 mm (No. 4) sieve, Methods A and B; or the material retained on the 19 mm (¾ in.) sieve, Methods C and D. The maximum dry density, corrected for oversized particles and total moisture content, are compared with the field-dry density and field moisture content.

This correction can be applied to the sample on which the maximum dry density is performed. A correction may not be practical for soils with only a small percentage of oversize material. The agency shall specify a minimum percentage below which the method is not needed. If not specified, this method applies when more than 5 percent by weight of oversize particles is present.

Bulk specific gravity (G_{sb}) of the oversized particles is required to determine the corrected maximum dry density. Use the bulk specific gravity as determined using the FOP for AASHTO T 85 in the calculations. For construction activities, an agency established value or specific gravity of 2.600 may be used.

This correction can also be applied to the sample obtained from the field while performing in-place density.

Procedure

1. Use the sample from this procedure or a sample obtained according to the FOP for AASHTO T 310.
2. Sieve the sample on the 4.75 mm (No. 4) sieve for Methods A and B or the 19 mm (¾ in.) sieve, Methods C and D.
3. Determine the dry mass of the oversized and fine fractions (M_{DC} and M_{DF}) by one of the following:
 - a. Dry the fractions, fine and oversized, in air or by use of a drying apparatus that is maintained at a temperature not exceeding 60°C (140°F).
 - b. Calculate the dry masses using the moisture samples.

To determine the dry mass of the fractions using moisture samples.

1. Determine the moist mass of both fractions, fine (M_{Mf}) and oversized (M_{Mc}):
2. Obtain moisture samples from the fine and oversized material.
3. Determine the moisture content of the fine particles (MC_f) and oversized particles (MC_c) of the material by FOP for AASHTO T 255/T 265 or agency approved method.
4. Calculate the dry mass of the oversize and fine particles.

$$M_D = \frac{M_m}{1 + MC}$$

Where:

M_D = mass of dry material (fine or oversize particles)

M_m = mass of moist material (fine or oversize particles)

MC = moisture content of respective fine or oversized, expressed as a decimal

5. Calculate the percentage of the fine (P_f) and oversized (P_c) particles by dry weight of the total sample as follows: See Note 2.

$$P_f = \frac{100 \times M_{DF}}{M_{DF} + M_{DC}} \quad \frac{100 \times 15.4 \text{ lb}}{15.4 \text{ lbs} + 5.7 \text{ lb}} = 73\% \quad \frac{100 \times 6.985 \text{ kg}}{6.985 \text{ kg} + 2.585 \text{ kg}} = 73\%$$

And

$$P_c = \frac{100 \times M_{DC}}{M_{DF} + M_{DC}} \quad \frac{100 \times 5.7 \text{ lb}}{15.4 \text{ lbs} + 5.7 \text{ lb}} = 27\% \quad \frac{100 \times 2.585 \text{ kg}}{6.985 \text{ kg} + 2.585 \text{ kg}} = 27\%$$

Or for P_c :

$$P_c = 100 - P_f$$

Where:

P_f = percent of fine particles, of sieve used, by weight

P_c = percent of oversize particles, of sieve used, by weight

M_{DF} = mass of dry fine particles

M_{DC} = mass of dry oversize particles

Optimum Moisture Correction Equation

1. Calculate the corrected moisture content as follows:

$$MC_T = \frac{(MC_F \times P_f) + (MC_C \times P_c)}{100} = \frac{(13.2\% \times 73.0\%) + (2.1\% \times 27.0\%)}{100} = 10.2\%$$

MC_T = corrected moisture content of combined fines and oversized particles, expressed as a % moisture

MC_F = moisture content of fine particles, as a % moisture

MC_C = moisture content of oversized particles, as a % moisture

Note 1: Moisture content of oversize material can be assumed to be two (2) percent for most construction applications.

Note 2: In some field applications agencies will allow the percentages of oversize and fine materials to be determined with the materials in the wet state.

Density Correction Equation

2. Calculate the corrected dry density (ρ_d) of the total sample (combined fine and oversized particles) as follows:

$$\rho_d = \frac{100\%}{\left[\left(\frac{P_f}{\rho_f}\right) + \left(\frac{P_c}{k}\right)\right]}$$

Where:

ρ_d = corrected total dry density (combined fine and oversized particles)
kg/m³ (lb/ft³)

ρ_f = dry density of the fine particles kg/m³ (lb/ft³), determined in the lab

P_c = percent of dry oversize particles, of sieve used, by weight.

P_f = percent of dry fine particles, of sieve used, by weight.

k = Metric: 1,000 * Bulk Specific Gravity (G_{sb}) (oven dry basis)
of coarse particles (kg/m³).

k = English: 62.4 * Bulk Specific Gravity (G_{sb}) (oven dry basis)
of coarse particles (lb/ft³)

Note 3: If the specific gravity is known, then this value will be used in the calculation. For most construction activities the specific gravity for aggregate may be assumed to be 2.600.

Calculation**Example**

• Metric:

Maximum laboratory dry density (ρ_f):	1880 kg/m ³
Percent coarse particles (P_c):	27%
Percent fine particles (P_f):	73%
Mass per volume coarse particles (k):	(2.697) (1000) = 2697 kg/m ³

$$\rho_d = \frac{100\%}{\left[\left(\frac{P_f}{\rho_f}\right) + \left(\frac{P_c}{k}\right)\right]}$$

$$\rho_d = \frac{100\%}{\left[\left(\frac{73\%}{1880 \text{ kg/m}^3}\right) + \left(\frac{27\%}{2697 \text{ kg/m}^3}\right)\right]}$$

$$\rho_d = \frac{100\%}{[0.03883 \text{ kg/m}^3 + 0.01001 \text{ kg/m}^3]}$$

$$\rho_d = 2047.5 \text{ kg/m}^3 \text{ report } 2048 \text{ kg/m}^3$$

EMBANKMENT AND BASE
IN-PLACE DENSITY

WAQTC

FOP AASHTO T 99 / T 180 (22)

English:

Maximum laboratory dry density (ρ_f): 117.3 lb/ft³

Percent coarse particles (P_c): 27%

Percent fine particles (P_f): 73%

Mass per volume of coarse particles (k): (2.697) (62.4) = 168.3 lb/ft³

$$\rho_d = \frac{100\%}{\left[\left(\frac{P_f}{\rho_f}\right) + \left(\frac{P_c}{k}\right)\right]}$$

$$\rho_d = \frac{100\%}{\left[\left(\frac{73\%}{117.3 \text{ lb/ft}^3}\right) + \left(\frac{27\%}{168.3 \text{ lb/ft}^3}\right)\right]}$$

$$\rho_d = \frac{100\%}{[0.6223 \text{ lb/ft}^3 + 0.1604 \text{ lb/ft}^3]}$$

$$\rho_d = \frac{100\%}{0.7827 \text{ lb/ft}^3}$$

$$\rho_d = 127.76 \text{ lb/ft}^3 \quad \text{Report } 127.8 \text{ lb/ft}^3$$

Report

- On forms approved by the agency
- Sample ID
- Corrected maximum dry density to the nearest 1 kg/m³ (0.1 lb/ft³)
- Corrected optimum moisture to the nearest 0.1 percent

ANNEX B**STANDARDIZATION OF THE MOLD**

(Mandatory Information)

Standardization is a critical step to ensure accurate test results when using this apparatus. Failure to perform the standardization procedure as described herein will produce inaccurate or unreliable test results.

Apparatus

- Mold and base plate
- Balance or scale – Accurate to within 45 g (0.1 lb) or 0.3 percent of the test load, whichever is greater, at any point within the range of use.
- Cover plate – A piece of plate glass, at least 6 mm (1/4 in.) thick and at least 25 mm (1 in.) larger than the diameter of the mold.
- Thermometers – Standardized liquid-in-glass, or electronic digital total immersion type, accurate to 0.5°C (1°F)

Procedure

1. Create a watertight seal between the mold and base plate.
2. Determine and record the mass of the dry sealed mold, base plate, and cover plate.
3. Fill the mold with water at a temperature between 16°C and 29°C (60°F and 85°F) and cover with the cover plate in such a way as to eliminate bubbles and excess water.
4. Wipe the outside of the mold, base plate, and cover plate dry, being careful not to lose any water from the mold.
5. Determine and record the mass of the filled mold, base plate, cover plate, and water.
6. Determine and record the mass of the water in the mold by subtracting the mass in Step 2 from the mass in Step 5.
7. Measure the temperature of the water and determine its density from Table B1, interpolating, as necessary.
8. Calculate the volume of the mold, V_m , by dividing the mass of the water in the mold by the density of the water at the measured temperature.

Calculations

$$V_m = \frac{M}{\rho_{water}}$$

Where:

 V_m = volume of the mold

M = mass of water in the mold

 ρ_{water} = density of water at the measured temperature**Example**

Mass of water in mold = 0.94367 kg (2.0800 lb)

 ρ_{water} at 23°C (73.4°F) = 997.54 kg/m³ (62.274 lb/ft³)

$$V_m = \frac{0.94367 \text{ kg}}{997.54 \text{ kg/m}^3} = 0.000946 \text{ m}^3 \quad V_m = \frac{2.0800 \text{ lb}}{62.274 \text{ lb/ft}^3} = 0.0334 \text{ ft}^3$$

Table B1
Unit Mass of Water
15°C to 30°C

°C	(°F)	kg/m ³	(lb/ft ³)	°C	(°F)	kg/m ³	(lb/ft ³)
15	(59.0)	999.10	(62.372)	23	(73.4)	997.54	(62.274)
15.6	(60.0)	999.01	(62.366)	23.9	(75.0)	997.32	(62.261)
16	(60.8)	998.94	(62.361)	24	(75.2)	997.29	(62.259)
17	(62.6)	998.77	(62.350)	25	(77.0)	997.03	(62.243)
18	(64.4)	998.60	(62.340)	26	(78.8)	996.77	(62.227)
18.3	(65.0)	998.54	(62.336)	26.7	(80.0)	996.59	(62.216)
19	(66.2)	998.40	(62.328)	27	(80.6)	996.50	(62.209)
20	(68.0)	998.20	(62.315)	28	(82.4)	996.23	(62.192)
21	(69.8)	997.99	(62.302)	29	(84.2)	995.95	(62.175)
21.1	(70.0)	997.97	(62.301)	29.4	(85.0)	995.83	(62.166)
22	(71.6)	997.77	(62.288)	30	(86.0)	995.65	(62.156)

EMBANKMENT AND BASE
IN-PLACE DENSITY

WAQTC

FOP AASHTO T 99 / T 180 (22)

Report

- Mold ID
- Date Standardized
- Temperature of the water
- Volume, V_m , of the mold to the nearest 0.000001 m^3 (0.0001 ft^3)

PERFORMANCE EXAM CHECKLIST

**MOISTURE-DENSITY RELATION OF SOILS
FOP FOR AASHTO T 99**

Participant Name _____ Exam Date _____

Record the symbols “P” for passing or “F” for failing on each step of the checklist.

Procedure Element	Trial 1	Trial 2
1. If damp, sample dried in air or drying apparatus, not exceeding 60°C (140°F)?	_____	_____
2. Sample broken up and an adequate amount sieved over the appropriate sieve (4.75 mm / No. 4 or 19.0 mm / 3/4 in.) to determine oversize (coarse particle) percentage?	_____	_____
3. Sample passing the sieve has appropriate mass?	_____	_____
4. If material is degradable:		
a. Multiple samples mixed with water varying moisture content by 1 to 2 percent, bracketing the optimum moisture content?	_____	_____
5. If soil is plastic (clay types):		
a. Multiple samples mixed with water varying moisture content by 1 to 2 percent, bracketing the optimum moisture content?	_____	_____
b. Samples placed in covered containers and allowed to stand for at least 12 hours?	_____	_____
6. Sample determined to be 4 to 8 percent below expected optimum moisture content?	_____	_____
7. Determine mass of clean, dry mold without collar to nearest 1 g (0.005 lb.)?	_____	_____
8. Mold placed on rigid and stable foundation?	_____	_____
9. Layer of soil (approximately one third compacted depth) placed in mold with collar attached, loose material lightly tamped?	_____	_____
10. Soil compacted with appropriate number of blows (25 or 56)?	_____	_____
11. Material adhering to the inside of the mold trimmed?	_____	_____
12. Layer of soil (approximately two thirds compacted depth) placed in mold with collar attached, loose material lightly tamped?	_____	_____
13. Soil compacted with appropriate number of blows (25 or 56)?	_____	_____
14. Material adhering to the inside of the mold trimmed?	_____	_____
15. Mold filled with soil such that compacted soil will be above the mold, loose material lightly tamped?	_____	_____

OVER

EMBANKMENT AND BASE
IN-PLACE DENSITY

WAQTC

FOP AASHTO T 99/T 180 (18)

Procedure Element

Trial 1 Trial 2

- 16. Soil compacted with appropriate number of blows (25 or 56)? _____
- 17. Collar removed without shearing off sample? _____
- 18. Approximately 6 mm (1/4 in.) of compacted material above the top of the mold (without the collar)? _____
- 19. Soil trimmed to top of mold with the beveled side of the straightedge? _____
- 20. Remove all soil from exterior surface of mold and base plate? _____
- 21. Mass of mold and contents determined to appropriate precision (1 g)? _____
- 22. Wet density calculated from the wet mass? _____
- 23. Soil removed from mold using a sample extruder if needed? _____
- 24. Soil sliced vertically through center (non-granular material)? _____
- 25. Moisture sample removed ensuring all layers are represented? _____
- 26. Moist mass determined immediately to 0.1 g? _____
- 27. Moisture sample mass of correct size? _____
- 28. Sample dried, and water content determined according to the FOP for T 255/T 265? _____
 - a. Remainder of material from mold broken up until it will pass through the sieve, as judged by eye, and added to remainder of original test sample? _____
 - b. Water added to increase moisture content of the remaining sample in approximately 1 to 2 percent increments? _____
 - c. Steps 7 through 29 repeated for each increment of water added? _____
- 29. Process continued until wet density either decreases or stabilizes? _____
- 30. Moisture content and dry density calculated for each sample? _____
- 31. Dry density plotted on vertical axis, moisture content plotted on horizontal axis, and points connected with a smooth curve? _____
- 32. Moisture content at peak of curve recorded as optimum water content and recorded to nearest 0.1 percent? _____
- 33. Dry density at optimum moisture content reported as maximum density to nearest 1 kg/m³ (0.1 lb/ft³)? _____
- 34. Corrected for coarse particles if applicable? _____

Comments: First attempt: Pass _____ Fail _____ Second attempt: Pass _____ Fail _____

Examiner Signature _____ WAQTC #: _____

WSDOT Errata to FOP for AASHTO R 97

Sampling Asphalt Mixtures

WAQTC FOP for AASHTO R 97 has been adopted by WSDOT with the following changes:

Sample Size

For Acceptance sampling and testing only: WSDOT requires a minimum of two times the amount required for testing. This should be approximately 60 lbs.

For Acceptance and Conformation sampling and testing or for Test Section sampling and testing: WSDOT requires a minimum of four times the amount required for testing. This should be approximately 120 lbs. (See WSDOT *Construction Manual* Section 9-3.7 for Conformation sampling frequency)

Note: When sampling or testing for Determination of the Moving Average of Theoretical Maximum Density (TMD) for Asphalt Mixtures, please refer to WSDOT SOP 729.

Procedure

General

Include the steps below:

- Immediately upon obtaining a sample, using a verified thermometer, check and record temperature of the sample.
- The material shall be tested to determine variations. The supplier/contractor shall sample the HMA mixture in the presence of the Project Engineer. The supplier/contractor shall provide one of the following for safe and representative sampling:
 - a. A mechanical sampling device installed between the discharge of the silo and the truck transport that is approved by the Regional Materials Engineer.
 - b. Platforms or devices to enable sampling from the truck transport without entering the truck transport for sampling Asphalt Mixtures.

Conveyor Belts - *Method not recognized by WSDOT.*

Paver Auger - *Method not recognized by WSDOT.*

Windrow - *Method not recognized by WSDOT.*

Roadway before Compaction

Method 1 - Obtaining a Sample on Grade or Untreated Base (Plate Method) - *Method not recognized by WSDOT.*

Method 2 - Obtaining a Sample on Asphalt Surface (Non-Plate Method) - *Method not recognized by WSDOT.*

Stockpiles

Method 1 – Loader - Method not recognized by WSDOT.

Method 2 – Stockpile Face - Method not recognized by WSDOT.

SAMPLING ASPHALT MIXTURES FOP FOR AASHTO R 97

Scope

This procedure covers sampling asphalt mixtures from plants, haul units, and roadways in accordance with AASHTO R 97-19. Sampling is as important as testing. Use care to obtain a representative sample. Avoid segregation and contamination of the material during sampling.

This standard does not purport to address all of the safety concerns, if any, associated with its use. It is the responsibility of the user of this standard to establish appropriate safety and health practices and determine the applicability of regulatory limitations prior to use.

Apparatus

- Shovel or Metal Scoops, or Other Equipment: square-head metal shovels at least 125 mm (5.5 in.) wide.
- Sample containers: such as cardboard boxes, metal cans, stainless steel bowls, or other agency-approved containers
- Sampling plate: thick metal plate, minimum 8 gauge, sized to accommodate sample requirements, with a wire attached to one corner long enough to reach from the center of the paver to the outside of the farthest auger extension. A minimum of one hole 6 mm (0.25 in.) in diameter must be provided in a corner of the plate.
- Cookie cutter sampling device: formed steel angle with two 100 mm by 150 mm by 9 mm (4 in. by 6 in. by 3/8 in.) handles, sized to accommodate sample requirements. Minimum 50 mm (2 in.) smaller than the sampling plate when used together.
Example: Sampling plate 380 mm (15 in.) square and a cookie cutter sampling device 330 mm (13 in.) square.
- Mechanical sampling device: a permanently attached device that allows a sample receptacle to pass perpendicularly through the entire stream of material or diverts the entire stream of material into the container by manual, hydraulic, or pneumatic operation.
- Release agent: a non-stick product that prevents the asphalt mixture from sticking to the apparatus and does not contain solvents or petroleum-based products that could affect asphalt binder properties.

Sample Size

Sample size depends on the test methods specified by the agency for acceptance. Check agency requirement for the size required.

Procedure

General

- Select sample locations using a random or stratified random sampling procedure, as specified by the agency. The material shall be tested to determine variations. The supplier/contractor shall provide equipment for safe and appropriate sampling, including sampling devices on plants when required.
- Ensure the container(s) and sampling equipment are clean and dry before sampling.
- For dense graded mixture samples use cardboard boxes, stainless steel bowls or other agency-approved containers.
- For hot open graded mixture samples use stainless steel bowls. Do not put open graded mixture samples in boxes until they have cooled to the point that asphalt binder will not migrate from the aggregate.

Attached Sampling Devices

These are normally permanently attached devices that allow a sample container to pass perpendicularly through the entire stream of material. Operation may be manual, pneumatic, or hydraulic and allow the sample container to pass through the stream twice without overfilling. A sampling device may also divert the entire stream into container.

1. Lightly coat the container attached to the sampling device with an agency-approved release agent or preheat it, or both, to approximately the same discharge temperature of the mix.
2. Pass the container twice, once in each direction, through the material perpendicularly without overfilling the container.
3. Transfer the asphalt mixture to an agency-approved container without loss of material.
4. Repeat until proper sample size has been obtained.
5. Combine the increments to form a single sample.

Conveyor Belts

1. Avoid sampling at the beginning or end of an asphalt mixture production run due to the potential for segregation.
2. Stop the belt containing asphalt mixture.
3. Set the sampling template into the asphalt mixture on the belt, avoiding intrusion by adjacent material.
4. Remove the asphalt mixture from inside the template, including all fines, and place in a sample container.
5. Repeat, obtaining equal size increments, until proper sample size has been obtained.
6. Combine the increments to form a single sample.

Haul Units

ASPHALT

WAQTC

FOP AASHTO R 97 (20)

1. Visually divide the haul unit into approximately four equal quadrants.
2. Identify one sampling location in each quadrant.
3. Dig down and remove approximately 0.3 m (1 ft.) of material to avoid surface segregation. Obtain each increment from below this level.
4. Combine the increments to form a sample of the required size.

Paver Auger

1. Obtain samples from the end of the auger using a square head shovel.
2. Place the shovel in front of the auger extension, with the shovel blade flat upon the surface to be paved over.
3. Allow the front face of the auger stream to cover the shovel with asphalt mixture, remove the shovel before the auger reaches it by lifting as vertically as possible.
4. Place asphalt mixture in a sample container.
5. Repeat until proper sample size has been obtained.
6. Combine the increments to form a sample of the required size.

Note 1: First full shovel of material may be discarded to preheat and 'butter' the shovel.

Windrow

1. Obtain samples from the windrow of a transport unit. Avoid the beginning or the end of the windrow section.
2. Visually divide the windrow into approximately three equal sections.
3. Remove approximately 0.3 m (1 ft) from the top of each section.
4. Fully insert the shovel into the flat surface as vertically as possible, exclude the underlying material, roll back the shovel and lift the material slowly out of the windrow to avoid material rolling off the shovel.
5. Place in a sample container.
6. Repeat, obtaining equal size increments, in each of the remaining thirds.
7. Combine the increments to form a sample of the required size.

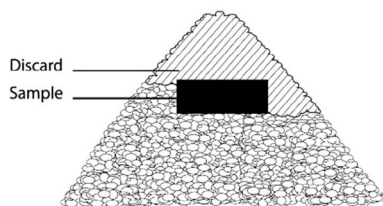

Windrow cross section

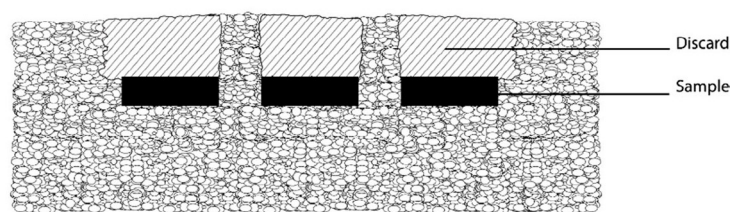

Windrow side view

Roadway before Compaction

There are two conditions that will be encountered when sampling asphalt mixtures from the roadway before compaction. The two conditions are:

- Laying asphalt mixture on grade or untreated base material requires Method 1.
- Laying asphalt mixture on existing asphalt or laying a second lift of asphalt mixture requires Method 2.

SAFETY:

Sampling is performed behind the paving machine and in front of the breakdown roller. For safety, the roller must remain at least 3 m (10 ft.) behind the sampling operation until the sample has been obtained and the hole filled with loose asphalt mixture.

Method 1 requires a plate to be placed in the roadway in front of the paving operation. There is always concern with moving, operating equipment. It is safest to stop the paving train while a plate is installed in front of the paver. When this is not possible the following safety rules must be followed.

1. The plate placing operation must be at least 3 m (10 ft.) in front of the paver or pickup device. The technician placing the plate must have eye contact and communication with the paving machine operator. If eye contact cannot be maintained at all times, a third person must be present to provide communication between the operator and the technician.
2. No technician is to be between the asphalt supply trucks and the paving machine. The exception to this rule is if the supply truck is moving forward creating a windrow, in which case the technician must be at least 3 m (10 ft.) behind the truck.

If at any time the Engineer feels that the sampling technique is creating an unsafe condition, the operation is to be halted until it is made safe, or the paving operation will be stopped while the plate is being placed.

Method 1 - Obtaining a Sample on Grade or Untreated Base (Plate Method)

1. Following the safety rules detailed above, the technician is to:
 - a. Smooth out a location in front of the paver at least 0.5 m (2 ft.) inside the edge of the mat.
 - b. Lay the plate down diagonally with the direction of travel, keeping it flat and tight to the base with the lead corner facing the paving machine.

Note 2: The plate may be secured by driving a nail through the hole in the lead corner of the plate.

2. Pull the wire, attached to the outside corner of the plate, taut past the edge of the asphalt mixture mat and secure it. Let the paving operation pass over the plate and wire.
3. Using the exposed end of the wire, pull the wire up through the fresh asphalt mixture to locate the corner of the plate.

- a. Plate only:
 - i. Using a small square head shovel, scoop, or both, remove the full depth of the asphalt mixture from the plate. Take care to prevent sloughing of adjacent material.
 - ii. Place asphalt mixture, including any material adhering to the plate and scoop or shovel in a sample container.
 - iii. Remove the sample cutter from the roadway. The hole made from the sampling must be filled by the contractor with loose asphalt mixture.
- b. "Cookie Cutter":
 - i. Place the "cookie cutter" sample device, just inside the end of the wire; align the cutter over the plate. Press "cookie cutter" device down through the asphalt mixture to the plate.
 - ii. Using a small square tipped shovel or scoop, or both, carefully remove all the asphalt mixture from inside of the cutter and place in a sample container.
 - iii. Remove the sample cutter and the plate from the roadway. The hole made from the sampling must be filled by the contractor with loose asphalt mixture.

Method 2 - Obtaining a Sample on Asphalt Surface (Non-plate Method)

1. After the paving machine has passed the sampling point, immediately place the "cookie cutter" sampling device on the location to be sampled.
2. Push the cutter down through the asphalt mixture until it is flat against the underlying asphalt mat.
3. Using a small square tipped shovel, scoop, or both, carefully remove all the asphalt mixture from inside of the cutter and place in a sample container.
4. Remove the cutter from the roadway. The hole made from the sampling must be filled by the contractor with loose asphalt mixture.

Stockpiles

Remove at least 0.1 m (4 in.) from the surface before sampling; mixtures in a stockpile may develop an oxidized crust.

Method 1 – Loader

1. Direct the loader operator to enter the stockpile with the bucket at least 0.3 m (1 ft) above ground level without contaminating the stockpile.
2. Obtain a full loader bucket of the asphalt mixture; tilt the bucket back and up.
3. Form a small sampling pile at the base of the stockpile by gently rolling the asphalt mixture out of the bucket with the bucket just high enough to permit free flow of the mixture. Repeat as necessary.
4. Create a flat surface by having the loader "back-drag" the small pile.

5. Obtain approximately equal increments from at least three randomly selected locations on the flat surface at least 0.3 m (1 ft) from the edge.
6. Fully insert the shovel, exclude the underlying material, roll back the shovel and lift the asphalt mixture slowly out of the pile to avoid mixture rolling off the shovel.
7. Combine the increments to form a sample.

Method 2 – Stockpile Face

1. Create horizontal surfaces with vertical faces in the top, middle, and bottom third of the stockpile with a shovel or a loader if one is available.
2. Shove a flat board against the vertical face behind the sampling location to prevent sloughing of asphalt mixture. Discard the sloughed mixture to create the horizontal surface.
3. Obtain the sample from the horizontal surface as close as possible to the intersection of the horizontal and vertical faces.
4. Obtain at least one sample increment of equal size from each of the top, middle, and bottom thirds of the pile.
5. Combine the increments to form a single sample.

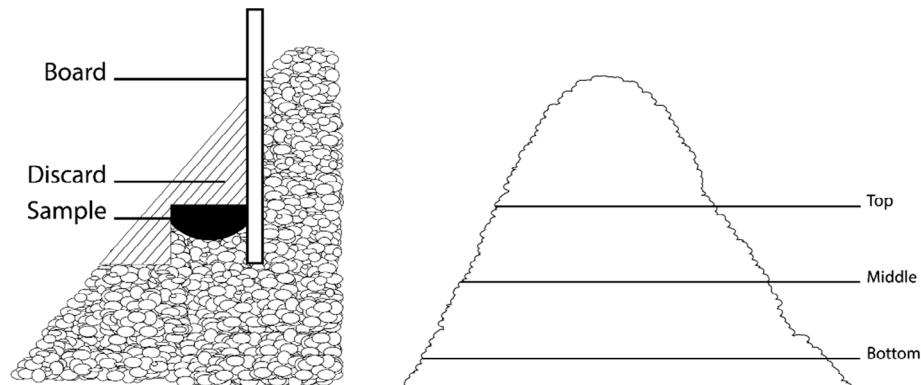

Identification and Shipping

1. Identify sample containers as required by the agency.
2. Ship samples in containers that will prevent loss, contamination, or damage.

ASPHALT

WAQTC

FOP AASHTO R 97 (20)

Report

- On forms approved by the agency
- Sample ID
- Date
- Time
- Location
- Quantity represented

ASPHALT

WAQTC

FOP AASHTO R 97 (20)

PERFORMANCE EXAM CHECKLIST

**SAMPLING ASPHALT MIXTURES
FOP FOR AASHTO R 97**

Participant Name _____ Exam Date _____

Record the symbols “P” for passing or “F” for failing on each step of the checklist.

Procedure Element	Trial 1	Trial 2
Attached Sampling Device		
1. Container coated or preheated or both?	_____	_____
2. Sampling device passed through stream twice perpendicular to material?	_____	_____
3. Sampling device not over filled?	_____	_____
Conveyor Belt		
4. Belt stopped?	_____	_____
5. Sampling template set on belt, avoiding intrusion of adjacent material?	_____	_____
6. Sample, including all fines, scooped off?	_____	_____
Haul Units		
7. Unit divided into four quadrants?	_____	_____
8. Increment obtained from each quadrant, 0.3 m (1ft.) below surface?	_____	_____
9. Increments combined to make up the sample?	_____	_____
Paver Auger		
10. Shovel blade flat on the surface to be paved?	_____	_____
11. Shovel lifted vertically after it is filled?	_____	_____
Windrow		
12. Beginning and end avoided?	_____	_____
13. Equal increments obtained from three sections?	_____	_____
14. Approximately 0.3 m (1 ft) removed from top of each section?	_____	_____
15. Underlying material excluded?	_____	_____
Roadway Before Compaction (Method 1)		
16. Plate placed well in front of paver?	_____	_____
17. Wire pulled to locate plate corner?	_____	_____

OVER

ASPHALT

WAQTC

FOP AASHTO R 97 (19)

Procedure Element

Trial 1 **Trial 2**

18. Cookie cutter (if used) placed on asphalt and pushed through to plate? _____

19. All material removed from inside the cutter? _____

Roadway Before Compaction (Method 2)

20. Cookie cutter placed on asphalt and pushed through to underlying material? _____

21. All material removed from inside the cutter? _____

Stockpile Method 1– (Loader sampling)

22. Loader operator directed to enter the stockpile with the bucket at least 0.3 m (1 ft) above ground level without contaminating the stockpile? _____

23. The loader obtained a full loader bucket of the material with the bucket tilted back and up? _____

24. A small sampling pile formed at the base of the stockpile by gently rolling the material out of the bucket with the bucket just high enough to permit free-flow of the material? _____

25. A flat surface created by the loader back dragging the small pile? _____

26. Increment sampled from three locations at least 0.3 m (1 ft) from the edge by fully inserting the shovel into the flat pile as vertically as possible, care taken to exclude the underlying material? _____

Stockpile Method 2 (Stockpile Face)

27. Created horizontal surfaces with vertical faces? _____

28. Sample obtained from the horizontal face as close as possible to the vertical face? _____

29. At least one increment taken from each of the top, middle, and bottom thirds of the stockpile? _____

General

30. Sample placed in appropriate container? _____

31. Sample size meets agency requirements? _____

32. Sample identified as required? _____

Comments: First attempt: Pass _____ Fail _____ Second attempt: Pass _____ Fail _____

Examiner Signature _____

WAQTC #: _____

ASPHALT

WAQTC

FOP AASHTO R 97 (19)

PERFORMANCE EXAM CHECKLIST (ORAL)**SAMPLING ASPHALT MIXTURES
FOP FOR AASHTO R 97**

Participant Name _____ Exam Date _____

Record the symbols "P" for passing or "F" for failing on each step of the checklist.

Procedure Element	Trial 1	Trial 2
1. At the hot plant, how must a sample be obtained using an attached sampling device?		
a. Coat or preheat sample container.	_____	_____
b. Sampling device passed through stream twice, once in each direction, perpendicular to material.	_____	_____
c. The sampling device cannot be overfilled.	_____	_____
2. How is a sample obtained from a conveyor belt?		
a. Stop the belt.	_____	_____
b. Set the sampling template on belt, avoiding intrusion of adjacent material.	_____	_____
c. All the material is removed from belt including all fines.	_____	_____
3. What must be done to sample from transport units?		
a. Divide the unit into four quadrants.	_____	_____
b. Obtain increments from each quadrant, 0.3 m (1 ft) below surface.	_____	_____
4. How is a sample obtained from the paver auger?		
a. Shovel blade is placed flat on the surface to be paved in front of the auger extension.	_____	_____
b. Shovel is filled and removed by lifting as vertically as possible.	_____	_____
5. Describe the procedure for sampling from a windrow.		
a. Do not sample from the beginning or end of the windrow.	_____	_____
b. Approximately 0.3 m (1 ft) removed from the top.	_____	_____
c. Underlying material is excluded	_____	_____
d. Equal increments obtained from 3 locations along the windrow.	_____	_____

OVER

Procedure Element

Trial 1 Trial 2

6. Describe how to take samples from the roadway using Method 1 (plate).

- a. Place the plate well in front of the paver. _____
- b. Pull the wire to locate the corner of the plate. _____
- c. Place the cutter (if used) on the asphalt material above the plate and push it down to the plate. _____
- d. Collect all the material inside the cutter. _____

7. Describe how to take samples from the roadway using Method 2.

- a. Place the cutter on the asphalt material and push it down to the underlying material. _____
- b. Collect all the material inside the cutter. _____

8. Describe the procedure for sampling a stockpile Method 1 (Loader Sampling).

- a. Loader removes surface and creates sampling pile. _____
- b. Loader back drags pile to create a flat surface. _____
- c. Take three approximately equal increments from at least 0.3 m (1 ft) from the edge, excluding the underlying material. _____

9. Describe the procedure for sampling a stockpile Method 2 (Stockpile Face Sampling).

- a. Create horizontal surfaces with vertical faces with a shovel. _____
- b. At least one increment taken from each of the top, middle, and bottom thirds of the stockpile. _____

10. Increments combined to form a sample of required size?

11. What types of containers can be used?

- a. Cardboard boxes, stainless steel bowls, or other agency approved containers. _____

12. What dictates size of sample?

- a. Agency requirements. _____
- b. Specified by test method. _____

Comments: First attempt: Pass_____Fail_____ Second attempt: Pass_____Fail_____

Examiner Signature _____

WAQTC #: _____

WSDOT Errata to FOP for AASHTO R 100

Method of Making and Curing Concrete Test Specimens in the Field

WAQTC FOP for AASHTO R 100 has been adopted by WSDOT with the following changes:

Scope

Include note below:

Note: WSDOT testing for determining compressive strength of concrete cylinder specimens shall require a set of two specimens made from the same sample.

Apparatus

- Initial curing facilities:

Include details below:

Cure Box – The cure box shall be a commercially manufactured cure box meeting AASHTO R 100 standards and the following requirements:

1. The interior shall be rustproof with a moisture-proof seal between the lid and the box.
2. The lid shall lock or have loops for padlocks that allow the box to be locked.
3. The box shall be equipped with a heating and cooling system. If the system uses a water circulating system, the box shall be equipped with a bottom drain and an overflow port. The cure box shall provide an environment that prevents loss of moisture from the specimens. The curing temperature and moist environment shall be controlled by the use of heating and cooling devices installed in the cure box.

Procedure – Initial Curing

Method 2 – Initial cure by burying in earth or by using a curing box over the cylinder – *Method not recognized by WSDOT.*

Include item below when required:

Field Curing

If the specimens are made and field cured, as stipulated herein, the resulting strength test data when the specimens are tested are able to be used for the following purposes:

- Determination of whether a structure is capable of being put in service.
- Comparison with test results of standard cured specimens or with test results from various in-place test methods,
- Adequacy of curing and protection of concrete in the structure.
- Form or shoring removal time requirements.

Cylinders – Store cylinders in or on the structure as near to the point of deposit of the concrete represented as possible. Protect all surfaces of the cylinders from the elements in as near as possible the same way as the formed work. Provide the cylinders with the same temperature and moisture environment as the structural work. Test the specimens in the moisture condition resulting from the specified curing treatment. To meet these conditions, specimens made for the purpose of determining when a structure is capable of being put in service shall be removed from the molds at the time of removal of form work.

Beams – After applying the curing compound to the top surface, cover the beam specimen with white reflective sheeting and allow beams to remain undisturbed for an initial cure period of 24 ± 4 hours at ambient conditions. After the initial cure period, remove the specimen from the mold and cure the specimen either by:

- (1) Burying the specimen in wet sand making sure that the specimen is never allowed to become surface dry. Temperature of the sand should be similar to the concrete pavement temperature.

Or

- (2) Wrap the beam in a saturated towel, place in a plastic bag, and seal the opening. The plastic should be at least 4 mils thick. Leave the specimen on the pavement in the vicinity where it was molded until time to test. Take specimen to the testing location and store in lime water at $73.4^\circ \pm 5^\circ\text{F}$ ($23^\circ \pm 2.8^\circ\text{C}$) for 24 ± 4 hours immediately before time of testing to ensure uniform moisture condition from specimen to specimen.

Note: The beam specimen must be kept in a surface moist condition or wet environment for the entire time in storage and testing. Even minor amounts of surface drying of the specimen induces extreme fiber stresses which can markedly reduce the flexural strength.

CONCRETE

WAQTC

FOP AASHTO R 100 (22)

METHOD OF MAKING AND CURING CONCRETE TEST SPECIMENS IN THE FIELD FOP FOR AASHTO R 100

Scope

This practice covers the method for making, initially curing, and transporting concrete test specimens in the field in accordance with AASHTO R 100-22.

Warning—Fresh Hydraulic cementitious mixtures are caustic and may cause chemical burns to skin and tissue upon prolonged exposure.

Apparatus

- Concrete cylinder molds: Conforming to AASHTO M 205 with a length equal to twice the diameter. Standard specimens shall be 150 mm (6 in.) by 300 mm (12 in.) cylinders. Mold diameter must be at least three times the maximum aggregate size unless wet sieving is conducted according to the FOP for WAQTC TM 2. Agency specifications may allow cylinder molds of 100 mm (4 in.) by 200 mm (8 in.) when the nominal maximum aggregate size does not exceed 25 mm (1 in.).
- Beam molds: Rectangular in shape with ends and sides at right angles to each other. Must be sufficiently rigid to resist warpage. Surfaces must be smooth. Molds shall produce length no more than 1.6 mm (1/16 in.) shorter than that required (greater length is allowed). Maximum variation from nominal cross section shall not exceed 3.2 mm (1/8 in.). Ratio of width to depth may not exceed 1:5; the smaller dimension must be at least 3 times the maximum aggregate size. Standard beam molds shall result in specimens having width and depth of not less than 150 mm (6 in.). Agency specifications may allow beam molds of 100 mm (4 in.) by 100 mm (4 in.) when the nominal maximum aggregate size does not exceed 25 mm (1 in.). Specimens shall be cast and hardened with the long axes horizontal.
- Standard tamping rod: 16 mm (5/8 in.) in diameter and 400 mm (16 in.) to 600 mm (24 in.) long, having a hemispherical tip of the same diameter as the rod for preparing 150 mm (6 in.) x 300 mm (12 in.) cylinders.
- Small tamping rod: 10 mm (3/8 in.) diameter and 305 mm (12 in.) to 600 mm (24 in.) long, having a hemispherical tip of the same diameter as the rod for preparing 100 mm (4 in.) x 200 mm (8 in.) cylinders.
- Vibrator: At least 9000 vibrations per minute, with a diameter no more than ¼ the diameter or width of the mold and at least 75 mm (3 in.) longer than the section being vibrated.
- Scoop: a receptacle of appropriate size so that each representative increment of the concrete sample can be placed in the container without spillage.
- Trowel or float

CONCRETE

WAQTC

FOP AASHTO R 100 (22)

- Mallet: With a rubber or rawhide head having a mass of 0.57 ± 0.23 kg (1.25 ± 0.5 lb.).
- Rigid base plates and cover plates: may be metal, glass, or plywood.
- Initial curing facilities: Temperature-controlled curing box or enclosure capable of maintaining the required range of 16 to 27°C (60 to 80°F) during the entire initial curing period (for concrete with compressive strength of 40 Mpa (6000 psi) or more, the temperature shall be 20 to 26°C (68 to 78°F). As an alternative, sand or earth for initial cylinder protection may be used provided that the required temperature range is maintained, and the specimens are not damaged.
- Thermometer: Capable of registering both maximum and minimum temperatures during the initial cure meeting the requirements for FOP for AASHTO T 309.

Procedure – Making Specimens – General

1. Obtain the sample according to the FOP for WAQTC TM 2.
2. Wet Sieving per the FOP for WAQTC TM 2 is required for 150 mm (6 in.) diameter specimens containing aggregate with a nominal maximum size greater than 50 mm (2 in.); screen the sample over the 50 mm (2 in.) sieve.
3. Remix the sample after transporting to testing location.
4. Begin making specimens within 15 minutes of obtaining the sample.
5. Set molds upright on a level, rigid base in a location free from vibration and relatively close to where they will be stored.
6. Fill molds in the required number of layers, attempting to slightly overfill the mold on the final layer. Add or remove concrete before completion of consolidation to avoid a deficiency or excess of concrete.
7. There are two methods of consolidating the concrete – rodding and internal vibration. If the slump is greater than 25 mm (1 in.), consolidation may be by rodding or vibration. When the slump is 25 mm (1 in.) or less, consolidate the sample by internal vibration. Agency specifications may dictate when rodding or vibration will be used.

Procedure – Making Cylinders – Self-Consolidating Concrete

1. Use the scoop to slightly overfill the mold. Evenly distribute the concrete in a circular motion around the inner perimeter of the mold.
2. Strike off the surface of the molds with tamping rod, straightedge, float, or trowel.
3. Immediately begin initial curing.

CONCRETE

WAQTC

FOP AASHTO R 100 (22)

Procedure – Making Cylinders – Rodding

1. For the standard 150 mm (6 in.) by 300 mm (12 in.) specimen, fill each mold in three approximately equal layers, moving the scoop or trowel around the perimeter of the mold to evenly distribute the concrete. For the 100 mm (4 in.) by 200 mm (8 in.) specimen, fill the mold in two layers. When filling the final layer, slightly overfill the mold.
2. Consolidate each layer with 25 strokes of the appropriate tamping rod, using the rounded end. Distribute strokes evenly over the cross section of the concrete. Rod the first layer throughout its depth without forcibly hitting the bottom. For subsequent layers, rod the layer throughout its depth penetrating approximately 25 mm (1 in.) into the underlying layer.
3. After rodding each layer, tap the sides of each mold 10 to 15 times with the mallet (reusable steel molds) or lightly with the open hand (single-use light-gauge molds).
4. Strike off the surface of the molds with tamping rod, straightedge, float, or trowel.
5. Immediately begin initial curing.

Procedure – Making Cylinders – Internal Vibration

1. Fill the mold in two layers.
2. Insert the vibrator at the required number of different points for each layer (two points for 150 mm (6 in.) diameter cylinders; one point for 100 mm (4 in.) diameter cylinders). When vibrating the bottom layer, do not let the vibrator touch the bottom or sides of the mold. When vibrating the top layer, the vibrator shall penetrate into the underlying layer approximately 25 mm (1 in.)
3. Remove the vibrator slowly, so that no large air pockets are left in the material.

Note 1: Continue vibration only long enough to achieve proper consolidation of the concrete. Over vibration may cause segregation and loss of appreciable quantities of intentionally entrained air.

4. After vibrating each layer, tap the sides of each mold 10 to 15 times with the mallet (reusable steel molds) or lightly with the open hand (single-use light-gauge molds).
5. Strike off the surface of the molds with tamping rod, straightedge, float, or trowel.
6. Immediately begin initial curing.

Procedure – Making Flexural Beams – Rodding

1. Fill the mold in two approximately equal layers with the second layer slightly overfilling the mold.
2. Consolidate each layer with the tamping rod once for every 1300 mm² (2 in²) using the rounded end. Rod each layer throughout its depth, taking care to not forcibly strike the bottom of the mold when compacting the first layer. Rod the second layer throughout its depth, penetrating approximately 25 mm (1 in.) into the lower layer.

CONCRETE

WAQTC

FOP AASHTO R 100 (22)

3. After rodding each layer, strike the mold 10 to 15 times with the mallet and spade along the sides and end using a trowel.
4. Strike off the surface of the molds with tamping rod, straightedge, float, or trowel.
5. Immediately begin initial curing.

Procedure – Making Flexural Beams – Vibration

1. Fill the mold to overflowing in one layer.
2. Consolidate the concrete by inserting the vibrator vertically along the centerline at intervals not exceeding 150 mm (6 in.). Take care to not over-vibrate and withdraw the vibrator slowly to avoid large voids. Do not contact the bottom or sides of the mold with the vibrator.
3. After vibrating, strike the mold 10 to 15 times with the mallet.
4. Strike off the surface of the molds with tamping rod, straightedge, float, or trowel.
5. Immediately begin initial curing.

Procedure – Initial Curing

- When moving cylinder specimens made with single use molds support the bottom of the mold with trowel, hand, or other device.
- For initial curing of cylinders, there are two methods, use of which depends on the agency. In both methods, the curing place must be firm, within ¼ in. of a level surface, and free from vibrations or other disturbances.
- Maintain initial curing temperature:
 - 16 to 27°C (60 to 80°F) for concrete with design strength up to 40 Mpa (6000 psi).
 - 20 to 26°C (68 to 78°F) for concrete with design strength of 40 Mpa (6000 psi) or more.
- Prevent loss of moisture.

Method 1 – Initial cure in a temperature-controlled chest-type curing box

1. Finish the cylinder using the tamping rod, straightedge, float, or trowel. The finished surface shall be flat with no projections or depressions greater than 3.2 mm (1/8 in.).
2. Place the mold in the curing box. When lifting light-gauge molds be careful to avoid distortion (support the bottom, avoid squeezing the sides).
3. Place the lid on the mold to prevent moisture loss.
4. Mark the necessary identification data on the cylinder mold and lid.

CONCRETE

WAQTC

FOP AASHTO R 100 (22)

Method 2 – Initial cure by burying in earth or by using a curing box over the cylinder

Note 2: This procedure may not be the preferred method of initial curing due to problems in maintaining the required range of temperature.

1. Move the cylinder with excess concrete to the initial curing location.
2. Mark the necessary identification data on the cylinder mold and lid.
3. Place the cylinder on level sand or earth, or on a board, and pile sand or earth around the cylinder to within 50 mm (2 in.) of the top.
4. Finish the cylinder using the tamping rod, straightedge, float, or trowel. Use a sawing motion across the top of the mold. The finished surface shall be flat with no projections or depressions greater than 3.2 mm (1/8 in.).
5. If required by the agency, place a cover plate on top of the cylinder and leave it in place for the duration of the curing period, or place the lid on the mold to prevent moisture loss.

Procedure – Transporting Specimens

- Initially cure the specimens for 24 to 48 hours. Transport specimens to the laboratory for final cure. Specimen identity will be noted along with the date and time the specimen was made and the maximum and minimum temperatures registered during the initial cure.
- Protect specimens from jarring, extreme changes in temperature, freezing, or moisture loss during transport.
- Secure cylinders so that the axis is vertical.
- Do not exceed 4 hours transportation time.

Final Curing

- Upon receiving cylinders at the laboratory, remove the cylinder from the mold and apply the appropriate identification.
- For all specimens (cylinders or beams), final curing must be started within 30 minutes of mold removal. Temperature shall be maintained at $23^{\circ} \pm 2^{\circ}\text{C}$ ($73 \pm 3^{\circ}\text{F}$). Free moisture must be present on the surfaces of the specimens during the entire curing period. Curing may be accomplished in a moist room or water tank conforming to AASHTO M 201.
- For cylinders, during the final 3 hours before testing the temperature requirement may be waived, but free moisture must be maintained on specimen surfaces at all times until tested and ambient temperature is between 20 to 30°C (68 to 80°F).
- Final curing of beams must include immersion in lime-saturated water for at least 20 hours before testing.

CONCRETE

WAQTC

FOP AASHTO R 100 (22)

Report

- On forms approved by the agency
- Pertinent placement information for identification of project, element(s) represented, etc.
- Sample ID
- Date and time molded.
- Test ages.
- Slump, air content, and density.
- Temperature (concrete, initial cure max. and min., and ambient).
- Method of initial curing.
- Other information as required by agency, such as: concrete supplier, truck number, invoice number, water added, etc.

CONCRETE

WAQTC

FOP AASHTO R 100 (21)

PERFORMANCE EXAM CHECKLIST

**MAKING AND CURING CONCRETE TEST SPECIMENS IN THE FIELD
FOP FOR AASHTO R 100 (4 X 8)**

Participant Name _____ Exam Date _____

Record the symbols “P” for passing or “F” for failing on each step of the checklist.

Procedure Element	Trial 1	Trial 2
1. Molds placed on a level, rigid, horizontal surface free of vibration?	_____	_____
2. Representative sample selected?	_____	_____
3. Making of specimens begun within 15 minutes of sampling?	_____	_____
First layer		
4. Concrete placed in the mold, moving a scoop or trowel around the perimeter of the mold to evenly distribute the concrete as discharged?	_____	_____
5. Mold filled approximately half full?	_____	_____
6. Layer rodded throughout its depth 25 times with hemispherical end of rod, uniformly distributing strokes?	_____	_____
7. Sides of the mold tapped 10-15 times after rodding?		
a. With mallet for reusable steel molds	_____	_____
b. With the open hand for flexible light-gauge molds	_____	_____
Second layer		
8. Concrete placed in the mold, moving a scoop or trowel around the perimeter of the mold to evenly distribute the concrete as discharged?	_____	_____
9. Mold slightly overfilled on the last layer?	_____	_____
10. Layer rodded 25 times with hemispherical end of rod, uniformly distributing strokes and penetrating 25 mm (1 in.) into the underlying layer?	_____	_____
11. Sides of the mold tapped 10-15 times after rodding each layer?		
a. With mallet for reusable steel molds	_____	_____
b. With the open hand for flexible light-gauge molds	_____	_____
12. Concrete struck off with tamping rod, float or trowel?	_____	_____
13. Specimens covered with non-absorptive, non-reactive cap or plate?	_____	_____
14. Initial curing addressed?	_____	_____

OVER

CONCRETE

WAQTC

FOP AASHTO R 100 (21)

Comments: First attempt: Pass____Fail____ Second attempt: Pass____Fail____

Examiner Signature _____ WAQTC # _____

This checklist is derived, in part, from copyrighted material printed in ACI CP-1, published by the American Concrete Institute.

CONCRETE

WAQTC

FOP AASHTO R 100 (21)

PERFORMANCE EXAM CHECKLIST

**MAKING AND CURING CONCRETE TEST SPECIMENS IN THE FIELD
FOP FOR AASHTO R 100 (6 X 12)**

Participant Name _____ Exam Date _____

Record the symbols “P” for passing or “F” for failing on each step of the checklist.

Procedure Element	Trial 1	Trial 2
1. Molds placed on a level, rigid, horizontal surface free of vibration?	_____	_____
2. Representative sample selected?	_____	_____
3. Making of specimens begun within 15 minutes of sampling?	_____	_____
First layer		
4. Concrete placed in the mold, moving a scoop or trowel around the perimeter of the mold to evenly distribute the concrete as discharged?	_____	_____
5. Mold filled approximately one third full?	_____	_____
6. Layer rodded throughout its depth 25 times with hemispherical end of rod, uniformly distributing strokes?	_____	_____
7. Sides of the mold tapped 10-15 times after rodding each layer?		
a. With mallet for reusable steel molds	_____	_____
b. With the open hand for flexible light-gauge molds	_____	_____
Second layer		
8. Concrete placed in the mold, moving a scoop or trowel around the perimeter of the mold to evenly distribute the concrete as discharged?	_____	_____
9. Mold filled approximately two thirds full?	_____	_____
10. Layer rodded 25 times with hemispherical end of rod, uniformly distributing strokes and penetrating 25 mm (1 in.) into the underlying layer?	_____	_____
11. Sides of the mold tapped 10-15 times after rodding?		
a. With mallet for reusable steel molds	_____	_____
b. With the open hand for flexible light-gauge molds	_____	_____
Third layer		
12. Concrete placed in the mold, moving a scoop or trowel around the perimeter of the mold to evenly distribute the concrete as discharged?	_____	_____

OVER

CONCRETE

WAQTC

FOP AASHTO R 100 (21)

Procedure Element

Trial 1 Trial 2

- 13. Mold slightly overfilled on the last layer? _____ _____
- 14. Layer rodded 25 times with hemispherical end of rod, uniformly distributing strokes and penetrating 25 mm (1 in.) into the underlying layer? _____ _____
- 15. Sides of the mold tapped 10-15 times after rodding?
 - a. With mallet for reusable steel molds _____ _____
 - b. With the open hand for flexible light-gauge molds _____ _____
- 16. Concrete struck off with tamping rod, straightedge, float, or trowel? _____ _____
- 17. Specimens covered with non-absorptive, non-reactive cap or plate? _____ _____
- 18. Initial curing addressed? _____ _____

Comments: First attempt: Pass _____ Fail _____ Second attempt: Pass _____ Fail _____

Examiner Signature _____ WAQTC #: _____

This checklist is derived, in part, from copyrighted material printed in ACI CP-1, published by the American Concrete Institute.

WSDOT FOP for AASHTO T 106

Compressive Strength of Hydraulic Cement Mortar (Using 50-mm or 2-in. Cube Specimens)

WSDOT has adopted the published AASHTO T 106 with errata's below.

AASHTO Test Methods cannot be included in Materials Manual due to copyright infringement.

WSDOT employees can access AASHTO and ASTM test methods in the following web address:

<http://wwwi.wsdot.wa.gov/MatsLab/BusinessOperations/ASTMLogin.htm>

Non-WSDOT employees can order AASHTO's Standard Specifications for Transportation Materials and Methods of Sampling and Testing, using the following web address:

<https://store.transportation.org>

10. Procedure

Follow Note below.

Note: For Field fabrication of grout cubes, follow WSDOT Test Method T 813.

Performance Exam Checklist

Compressive Strength of Hydraulic Cement Mortar (Using 50-mm or 2-in. Cube specimens) AASHTO T 106

Participant Name _____ Exam Date _____

Record the symbols "P" for passing or "F" for failing on each step of the checklist.

Procedure Element	Trial 1	Trial 2
1. The tester has a copy of the current procedure on hand?	_____	_____
2. All equipment is functioning according to the test procedure, and if required has the current calibration/standardization/check and maintenance tags present?	_____	_____
3. Cubes broken within permissible time tolerance?	_____	_____
4. Cubes tested immediately after removal from saturated lime water storage tank or covered with damp cloth?	_____	_____
5. Cubes wiped clean of sand, and wiped to surface dry condition prior to testing?	_____	_____
6. Load applied to specimen faces that were in contact with plane surfaces of mold and checked with straightedge?	_____	_____
7. Cross-sectional area determined in respect to faces contacting bearing blocks?	_____	_____
8. Prior to testing each cube, spherically seated block checked for freedom to tilt?	_____	_____
9. Load rate of 200 to 400 lbf/s (900-1800 N/s) obtained during the first half of the anticipated maximum load?	_____	_____
10. No adjustment in rate made during the second half of loading?	_____	_____
11. Total maximum load recorded and compressive strength of cubes averaged and reported to the nearest 10 psi (0.1 MPa)?	_____	_____

First Attempt: Pass Fail Second Attempt: Pass Fail

Signature of Examiner _____

Comments:

SLUMP OF HYDRAULIC CEMENT CONCRETE FOP FOR AASHTO T 119

Scope

This procedure provides instructions for determining the slump of hydraulic cement concrete in accordance with AASHTO T 119-18. It is not applicable to non-plastic and non-cohesive concrete.

Warning—Fresh Hydraulic cementitious mixtures are caustic and may cause chemical burns to skin and tissue upon prolonged exposure.

Apparatus

- Mold: conforming to AASHTO T 119
 - Metal: a metal frustum of a cone provided with foot pieces and handles. The mold must be constructed without a seam. The interior of the mold shall be relatively smooth and free from projections such as protruding rivets. The mold shall be free from dents. A mold that clamps to a rigid nonabsorbent base plate is acceptable provided the clamping arrangement is such that it can be fully released without movement of the mold.
 - Non-metal: see AASHTO T 119, Section 5.1.2.
- Tamping rod: 16 mm (5/8 in.) diameter and 400 mm (16 in.) to 600 mm (24 in.) long, having a hemispherical tip the same diameter as the rod. (Hemispherical means “half a sphere”; the tip is rounded like half of a ball.)
- Scoop: a receptacle of appropriate size so that each representative increment of the concrete sample can be placed in the container without spillage.
- Tape measure or ruler with at least 5 mm or 1/8 in. graduations
- Base: flat, rigid, non-absorbent moistened surface on which to set the slump mold

Procedure

1. Obtain the sample in accordance with the FOP for WAQTC TM 2. If the concrete mixture contains aggregate retained on the 37.5mm (1½ in.) sieve, the aggregate must be removed in accordance with the Wet Sieving portion of the FOP for WAQTC TM 2.

Begin testing within five minutes of obtaining the sample.

2. Dampen the inside of the mold and place it on a dampened, rigid, nonabsorbent surface that is level and firm.
3. Stand on both foot pieces to hold the mold firmly in place.
4. Use the scoop to fill the mold 1/3 full by volume, to a depth of approximately 67 mm (2 5/8 in.).

5. Consolidate the layer with 25 strokes of the tamping rod, using the rounded end. Distribute the strokes evenly over the entire cross section of the concrete.
For this bottom layer, incline the rod slightly and make approximately half the strokes near the perimeter, and then progress with vertical strokes, spiraling toward the center.
 6. Use the scoop to fill the mold 2/3 full by volume, to a depth of approximately 155 mm (6 1/8 in.).
 7. Consolidate this layer with 25 strokes of the tamping rod, penetrate approximately 25 mm (1 in.) into the bottom layer. Distribute the strokes evenly.
 8. Use the scoop to fill the mold to overflowing.
 9. Consolidate this layer with 25 strokes of the tamping rod, penetrate approximately 25 mm (1 in.) into the second layer. Distribute the strokes evenly. If the concrete falls below the top of the mold, stop, add more concrete, and continue rodding for a total of 25 strokes. Keep an excess amount of concrete above the top of the mold at all times. Distribute strokes evenly as before.
 10. Strike off the top surface of concrete with a screeding and rolling motion of the tamping rod.
 11. Clean overflow concrete away from the base of the mold.
 12. Remove the mold from the concrete by raising it carefully in a vertical direction. Raise the mold 300 mm (12 in.) in 5 ± 2 seconds by a steady upward lift with no lateral or torsional (twisting) motion being imparted to the concrete.
Complete the entire operation from the start of the filling through removal of the mold without interruption within an elapsed time of 2 1/2 minutes.
 13. Immediately measure the slump:
 - a. Invert the slump mold and set it next to the specimen.
 - b. Lay the tamping rod across the mold so that it is over the test specimen.
 - c. Measure the distance between the bottom of the rod and the displaced original center of the top of the specimen to the nearest 5 mm (1/4 in.).
- Note 1:* If a decided falling away or shearing off of concrete from one side or portion of the mass occurs, disregard the test and perform a new test on another portion of the sample. If two consecutive tests on a sample of concrete show a falling away or shearing off of a portion of the concrete from the mass of the specimen, the concrete probably lacks the plasticity and cohesiveness necessary for the slump test to be applicable.
14. Discard the tested sample.

Report

- Results on forms approved by the agency
- Sample ID
- Slump to the nearest 5 mm (1/4 in.).

PERFORMANCE EXAM CHECKLIST

**SLUMP OF HYDRAULIC CEMENT CONCRETE
FOP FOR AASHTO T 119**

Participant Name _____ Exam Date _____

Record the symbols “P” for passing or “F” for failing on each step of the checklist.

Procedure Element	Trial 1	Trial 2
First layer		
1. Mold and floor or base plate dampened?	_____	_____
2. Mold held firmly against the base by standing on the two foot pieces? Mold not allowed to move in any way during filling?	_____	_____
3. Representative sample scooped into the mold, moving a scoop around the perimeter of the mold to evenly distribute the concrete as discharged?	_____	_____
4. Mold approximately one third (by volume), 67 mm (2 5/8 in.) deep?	_____	_____
5. Layer rodded throughout its depth 25 times with hemispherical end of rod, uniformly distributing strokes?	_____	_____
Second layer		
6. Representative samples scooped into the mold, moving a scoop around the perimeter of the mold to evenly distribute the concrete as discharged?	_____	_____
7. Mold filled approximately two thirds (by volume), 155 mm (6 1/8 in.), deep?	_____	_____
8. Layer rodded throughout its depth 25 times with hemispherical end of rod, uniformly distributing strokes, penetrate approximately 25 mm (1 in.) into the bottom layer?	_____	_____
Third layer		
9. Representative sample scooped into the mold, moving a scoop around the perimeter of the mold to evenly distribute the concrete as discharged??	_____	_____
10. Mold filled to just over the top of the mold?	_____	_____
11. Layer rodded throughout its depth 25 times with hemispherical end of rod, uniformly distributing strokes, penetrate approximately 25 mm (1 in.) into the second layer?	_____	_____
12. Excess concrete kept above the mold at all times while rodding?	_____	_____
13. Concrete struck off level with top of mold using tamping rod?	_____	_____

OVER

CONCRETE

WAQTC

FOP AASHTO T 119 (16)

Procedure Element

Trial 1 Trial 2

- 14. Concrete removed from around the outside bottom of the mold? _____
- 15. Mold lifted upward 300 mm (12 in.) in one smooth motion, without a lateral or twisting motion of the mold, in 5 ±2 seconds? _____
- 16. Test performed from start of filling through removal of the mold within 2 1/2 minutes? _____
- 17. Slump immediately measured to the nearest 5 mm (1/4 in.) from the top of the mold to the displaced original center of the top surface of the specimen? _____

Comments: First attempt: Pass _____ Fail _____ Second attempt: Pass _____ Fail _____

Examiner Signature _____ WAQTC #: _____

This checklist is derived, in part, from copyrighted material printed in ACI CP-1, published by the American Concrete Institute.

DENSITY (UNIT WEIGHT), YIELD, AND AIR CONTENT (GRAVIMETRIC) OF CONCRETE FOP FOR AASHTO T 121

Scope

This method covers the determination of density, or unit weight, of freshly mixed concrete in accordance with AASHTO T 121-19. It also provides formulas for calculating the volume of concrete produced from a mixture of known quantities of component materials and provides a method for calculating cement content and cementitious material content – the mass of cement or cementitious material per unit volume of concrete. A procedure for calculating water/cement ratio is also covered.

Warning—Fresh Hydraulic cementitious mixtures are caustic and may cause chemical burns to skin and tissue upon prolonged exposure.

Apparatus

- Measure: May be the bowl portion of the air meter used for determining air content under the FOP for AASHTO T 152. Otherwise, it shall be a cylindrical metal container meeting the requirements of AASHTO T 121. The capacity and dimensions of the measure shall conform to those specified in Table 1.
- Balance or scale: Accurate to within 45 g (0.1 lb) or 0.3 percent of the test load, whichever is greater, at any point within the range of use.
- Tamping rod: 16 mm (5/8 in.) diameter and 400 mm (16 in.) to 600 mm (24 in.) long, having a hemispherical tip the same diameter as the rod. (Hemispherical means “half a sphere”; the tip is rounded like half of a ball.)
- Vibrator: frequency at least 9000 vibrations per minute (150 Hz), at least 19 to 38 mm (3/4 to 1 1/2 in.) in diameter but not greater than 38 mm (1 1/2 in.), and the length of the shaft shall be at least 75 mm (3 in.) longer than the depth of the section being vibrated.
- Scoop: a receptacle of appropriate size so that each representative increment of the concrete sample can be placed in the container without spillage.
- Strike-off plate: A flat rectangular metal plate at least 6 mm (1/4 in.) thick or a glass or acrylic plate at least 12 mm (1/2 in.) thick, with a length and width at least 50 mm (2 in.) greater than the diameter of the measure with which it is to be used. The edges of the plate shall be straight and smooth within tolerance of 1.5 mm (1/16 in.).
- Mallet: With a rubber or rawhide head having a mass of 0.57 ± 0.23 kg (1.25 ± 0.5 lb) for use with measures of 0.014 m^3 ($1/2 \text{ ft}^3$) or less or having a mass of 1.02 ± 0.23 kg (2.25 ± 0.5 lb) for use with measures of 0.028 m^3 (1 ft^3).

Table 1
Dimensions of Measures*

Capacity m ³ (ft ³)	Inside Diameter mm (in.)	Inside Height mm (in.)	Minimum Thicknesses mm (in.)		Nominal Maximum Size of Coarse Aggregate*** mm (in.)
			Bottom	Wall	
0.0071	203 ±2.54	213 ±2.54	5.1	3.0	25
(1/4)**	(8.0 ±0.1)	(8.4 ±0.1)	(0.20)	(0.12)	(1)
0.0142	254 ±2.54	279 ±2.54	5.1	3.0	50
(1/2)	(10.0 ±0.1)	(11.0 ±0.1)	(0.20)	(0.12)	(2)
0.0283	356 ±2.54	284 ±2.54	5.1	3.0	76
(1)	(14.0 ±0.1)	(11.2 ±0.1)	(0.20)	(0.12)	(3)

* **Note 1:** The indicated size of measure shall be for aggregates of nominal maximum size equal to or smaller than that listed.

** Measure may be the base of the air meter used in the FOP for AASHTO T 152.

*** Nominal maximum size: One sieve larger than the first sieve to retain more than 10 percent of the material using an agency specified set of sieves based on cumulative percent retained. Where large gaps in specification sieves exist, intermediate sieve(s) may be inserted to determine nominal maximum size.

Procedure Selection

There are two methods of consolidating the concrete – rodding and vibration. If the slump is greater than 75 mm (3 in.), consolidation is by rodding. When the slump is 25 to 75 mm (1 to 3 in.), internal vibration or rodding can be used to consolidate the sample, but the method used must be that required by the agency in order to obtain consistent, comparable results. For concrete with slump less than 25 mm (1 in.), consolidate the sample by internal vibration. Do not consolidate self-consolidating concrete (SCC).

When using measures greater than 0.0142 m³ (1/2 ft³) see AASHTO T 121.

Procedure

Sampling

1. Obtain the sample in accordance with the FOP for WAQTC TM 2. Testing may be performed in conjunction with the FOP for AASHTO T 152. When doing so, this FOP should be performed before the FOP for AASHTO T 152.

Note 2: If the two tests are being performed using the same sample, this test shall begin within five minutes of obtaining the sample.

Rodding

1. Determine and record the mass of the empty measure.
2. Dampen the inside of the measure and empty excess water.

CONCRETE

WAQTC

FOP AASHTO T 121 (20)

3. Use the scoop to fill the measure approximately 1/3 full with concrete. Evenly distribute the concrete in a circular motion around the inner perimeter of the measure.
4. Consolidate the layer with 25 strokes of the tamping rod, using the rounded end. Distribute the strokes evenly over the entire cross section of the concrete. Rod throughout its depth without hitting the bottom too hard.
5. Tap around the perimeter of the measure smartly 10 to 15 times with the mallet to close voids and release trapped air.
6. Add the second layer, filling the measure about 2/3 full. Evenly distribute the concrete in a circular motion around the inner perimeter of the measure.
7. Consolidate this layer with 25 strokes of the tamping rod, penetrating about 25 mm (1 in.) into the bottom layer.
8. Tap around the perimeter of the measure smartly 10 to 15 times with the mallet.
9. Add the final layer, slightly overfilling the measure. Evenly distribute the concrete in a circular motion around the inner perimeter of the measure.
10. Consolidate this layer with 25 strokes of the tamping rod, penetrating about 25 mm (1 in.) into the second layer.
11. Tap around the perimeter of the measure smartly 10 to 15 times with the mallet.
12. After consolidation, the measure should be slightly over full, about 3 mm (1/8 in.) above the rim. If there is a great excess of concrete, remove a portion with the scoop. If the measure is under full, add a small quantity. This adjustment may be done only after consolidating the final layer and before striking off the surface of the concrete.
13. Continue with 'Strike-off and Determining Mass.'

Internal Vibration

1. Determine and record the mass of the empty measure.
2. Dampen the inside of the measure and empty excess water.
3. Use the scoop to fill the measure approximately 1/2 full with concrete. Evenly distribute the concrete in a circular motion around the inner perimeter of the measure.
4. Insert the vibrator at three different points in each layer. Do not let the vibrator touch the bottom or side of the measure. Continue vibration only long enough to achieve proper consolidation of the concrete. Over vibration may cause segregation and loss of appreciable quantities of intentionally entrained air.
5. Tap around the perimeter of the measure smartly 10 to 15 times with the mallet.
6. Slightly overfill the measure. Evenly distribute the concrete in a circular motion around the inner perimeter of the measure.
7. Insert the vibrator at three different points, penetrating the first layer approximately 25 mm (1 in.). Do not let the vibrator touch the side of the measure.
8. Tap around the perimeter of the measure smartly 10 to 15 times with the mallet.

9. After consolidation, the measure should be slightly over full, about 3 mm (1/8 in.) above the rim. If there is a great excess of concrete, remove a portion with the scoop. If the measure is under full, add a small quantity. This adjustment may be done only after consolidating the final layer and before striking off the surface of the concrete.
10. Continue with 'Strike-off and Determining Mass.'

Self-Consolidating Concrete

1. Determine and record the mass of the empty measure.
2. Dampen the inside of the measure and empty excess water.
3. Use the scoop to slightly overfill the measure. Evenly distribute the concrete in a circular motion around the inner perimeter of the measure.
5. Continue with 'Strike-off and Determining Mass.'

Strike-off and Determining Mass

1. Press the strike-off plate flat against the top surface, covering approximately 2/3 of the measure.
2. Withdraw the strike-off plate with a sawing motion to finish the 2/3 originally covered.
3. Cover the original 2/3 again with the plate; finishing the remaining 1/3 with a sawing motion (do not lift the plate; continue the sawing motion until the plate has cleared the surface of the measure).
4. Final finishing may be accomplished with several strokes with the inclined edge of the strike-off plate. The surface should be smooth and free of voids.
5. Clean off all excess concrete from the exterior of the measure including the rim.
6. Determine and record the mass of the measure and the concrete.
7. If the air content of the concrete is to be determined, ensure the rim (flange) is clean and proceed to 'Strike-off and Air Content' Step 3 of the FOP for AASHTO T 152.

Calculations

Mass of concrete in the measure

$$\text{concrete mass} = M_c - M_m$$

Where:

Concrete mass = mass of concrete in measure

M_c = mass of measure and concrete

M_m = mass of measure

Density

$$\rho = \frac{\text{concrete mass}}{V_m}$$

Where:

ρ = density of the concrete mix

V_m = volume of measure (Annex A)

Yield m^3

$$Y_{m^3} = \frac{W}{\rho}$$

Where:

Y_{m^3} = yield (m^3 of the batch of concrete)

W = total mass of the batch of concrete

Yield yd³

$$Y_{ft^3} = \frac{W}{\rho} \qquad Y_{yd^3} = \frac{Y_{ft^3}}{27ft^3/yd^3}$$

Where:

Y_{ft^3}	=	yield (ft ³ of the batch of concrete)
Y_{yd^3}	=	yield (yd ³ of the batch of concrete)
W	=	total mass of the batch of concrete
ρ	=	density of the concrete mix

Note 5: The total mass, W, includes the masses of the cement, water, and aggregates in the concrete.

Cement Content

$$N = \frac{N_t}{Y}$$

Where:

N	=	actual cementitious material content per Y_m^3 or Y_{yd^3}
N_t	=	mass of cementitious material in the batch
Y	=	Y_m^3 or Y_{yd^3}

Note 6: Specifications may require Portland Cement content and supplementary cementitious materials content.

Water Content

The mass of water in a batch of concrete is the sum of:

- water added at batch plant
- water added in transit
- water added at jobsite
- free water on coarse aggregate*
- free water on fine aggregate*
- liquid admixtures (if required by the agency)

*Mass of free water on aggregate

This information is obtained from concrete batch tickets collected from the driver. Use the Table 2 to convert liquid measures.

Table 2
Liquid Conversion Factors

To Convert From	To	Multiply By
Liters, L	Kilograms, kg	1.0
Gallons, gal	Kilograms, kg	3.785
Gallons, gal	Pounds, lb	8.34
Milliliters, mL	Kilograms, kg	0.001
Ounces, oz	Milliliters, mL	28.4
Ounces, oz	Kilograms, kg	0.0284
Ounces, oz	Pounds, lb	0.0625
Pounds, lb	Kilograms, kg	0.4536

Mass of free water on aggregate

$$\text{Free Water Mass} = \text{CA or FC Aggregate} - \frac{\text{CA or FC Aggregate}}{1 + (\text{Free Water Percentage}/100)}$$

Where:

- Free Water Mass = on coarse or fine aggregate
 FC or CA Aggregate = mass of coarse or fine aggregate
 Free Water Percentage = percent of moisture of coarse or fine aggregate

Water/Cement Ratio

$$\frac{\text{Water Content}}{C}$$

Where:

- Water Content = total mass of water in the batch
 C = total mass of cementitious materials

CONCRETE

WAQTC

FOP AASHTO T 121 (20)

Example

Mass of concrete in measure (M_m)	16.290 kg (36.06 lb)
Volume of measure (V_m)	0.007079 m ³ (0.2494 ft ³)

From batch ticket:

Yards batched	4 yd ³
Cement	950 kg (2094 lb)
Fly ash	180 kg (397 lb)
Coarse aggregate	3313 kg (7305 lb)
Fine aggregate	2339 kg (5156 lb)
Water added at plant	295 L (78 gal)

Other

Water added in transit	0
Water added at jobsite	38 L (10 gal)
Total mass of the batch of concrete (W)	7115 kg (15,686 lb)
Moisture content of coarse aggregate	1.7%
Moisture content of coarse aggregate	5.9%

CONCRETE

WAQTC

FOP AASHTO T 121 (20)

Density

$$\rho = \frac{\text{concrete mass}}{V_m}$$

$$\rho = \frac{16.920 \text{ kg}}{0.007079 \text{ m}^3} = 2390 \text{ kg/m}^3 \quad \rho = \frac{36.06 \text{ lb}}{0.2494 \text{ ft}^3} = 144.6 \text{ lb/ft}^3$$

Given:

$$\text{concrete mass} = 16.920 \text{ kg (36.06 lb)}$$

$$V_m = 0.007079 \text{ m}^3 (0.2494 \text{ ft}^3) \text{ (Annex A)}$$

Yield m³

$$Y_{m^3} = \frac{W}{\rho}$$

$$Y_{m^3} = \frac{7115 \text{ kg}}{2390 \text{ kg/m}^3} = 2.98 \text{ m}^3$$

Given:

$$\text{Total mass of the batch of concrete (W), kg} = 7115 \text{ kg}$$

CONCRETE

WAQTC

FOP AASHTO T 121 (20)

Yield yd^3

$$Y_{ft^3} = \frac{W}{\rho}$$

$$Y_{yd^3} = \frac{Y_{ft^3}}{27 ft^3/yd^3}$$

$$Y_{ft^3} = \frac{15,686 lb}{144.6 lb/ft^3} = 108.48 ft^3 \quad Y_{yd^3} = \frac{108.48 ft^3}{27 ft^3/yd^3} = 4.02 yd^3$$

Given:

Total mass of the batch of concrete (W), lb = 15,686 lb

Cement Content

$$N = \frac{N_t}{Y}$$

$$N = \frac{950 kg + 180 kg}{2.98 m^3} = 379 kg/m^3 \quad N = \frac{2094 lb + 397 lb}{4.02 yd^3} = 620 lb/yd^3$$

Given:

$$N_i \text{ (cement)} = 950 kg (2094 lb)$$

$$N_i \text{ (flyash)} = 180 kg (397 lb)$$

$$Y = Y_m^3 \text{ or } Y_{yd^3}$$

Note 6: Specifications may require Portland Cement content and supplementary cementitious materials content.

CONCRETE

WAQTC

FOP AASHTO T 121 (20)

Free water

$$\text{Free Water Mass} = \text{CA or FC Aggregate} - \frac{\text{CA or FC Aggregate}}{1 + (\text{Free Water Percentage}/100)}$$

$$\text{CA Free Water} = 3313 \text{ kg} - \frac{3313 \text{ kg}}{1 + (1.7/100)} = 55 \text{ kg}$$

$$\text{CA Free Water} = 7305 \text{ lb} - \frac{7305 \text{ lb}}{1 + (1.7/100)} = 122 \text{ lb}$$

$$\text{FA Free Water} = 2339 \text{ kg} - \frac{2339 \text{ kg}}{1 + (5.9/100)} = 130 \text{ kg}$$

$$\text{FA Free Water} = 5156 \text{ lb} - \frac{5156 \text{ lb}}{1 + (5.9/100)} = 287 \text{ lb}$$

Given:

CA aggregate = 3313 kg (7305 lb)

FC aggregate = 2339 kg (5156 lb)

CA moisture content = 1.7%

FC moisture content = 5.9%

CONCRETE

WAQTC

FOP AASHTO T 121 (20)

Water Content

Total of all water in the mix.

$$\text{Water Content} = [(78 \text{ gal} + 10 \text{ gal}) * 3.785 \text{ kg/gal}] + 55 \text{ kg} + 130 \text{ kg} = 518 \text{ kg}$$

$$\text{Water Content} = [(78 \text{ gal} + 10 \text{ gal}) * 8.34 \text{ lb/gal}] + 122 \text{ lb} + 287 \text{ lb} = 1143 \text{ lb}$$

Given:

$$\text{Water added at plant} = 295 \text{ L (78 gal)}$$

$$\text{Water added at the jobsite} = 38 \text{ L (10 gal)}$$

Water/ Cement Ratio

$$W/C = \frac{518 \text{ kg}}{950 \text{ kg} + 180 \text{ kg}} = 0.458 \quad W/C = \frac{1143 \text{ lb}}{2094 \text{ lb} + 397 \text{ lb}} = 0.459$$

Report 0.46**Report**

- Results on forms approved by the agency
- Sample ID
- Density (unit weight) to the nearest 1 kg/m³ (0.1 lb/ft³)
- Yield to the nearest 0.01 m³ (0.01 yd³)
- Cement content to the nearest 1 kg/m³ (1 lb/yd³)
- Cementitious material content to the nearest 1 kg/m³ (1 lb/yd³)
- Water/Cement ratio to the nearest 0.01

ANNEX A – STANDARDIZATION OF MEASURE

(Mandatory Information)

Standardization is a critical step to ensure accurate test results when using this apparatus. Failure to perform the standardization procedures as described herein will produce inaccurate or unreliable test results.

Apparatus

- Listed in the FOP for AASHTO T 121
 - Measure
 - Balance or scale
 - Strike-off plate
- Thermometer: Standardized liquid-in-glass, or electronic digital total immersion type, accurate to 0.5°C (1°F)

Procedure

1. Determine the mass of the dry measure and strike-off plate.
2. Fill the measure with water at a temperature between 16°C and 29°C (60°F and 85°F) and cover with the strike-off plate in such a way as to eliminate bubbles and excess water.
3. Wipe the outside of the measure and cover plate dry, being careful not to lose any water from the measure.
4. Determine the mass of the measure, strike-off plate, and water in the measure.
5. Determine the mass of the water in the measure by subtracting the mass in Step 1 from the mass in Step 4.
6. Measure the temperature of the water and determine its density from Table A1, interpolating as necessary.
7. Calculate the volume of the measure, V_m , by dividing the mass of the water in the measure by the density of the water at the measured temperature.

Calculations

$$V_m = \frac{M}{\rho_w}$$

Where:

 V_m = volume of the mold M = mass of water in the mold ρ_w = density of water at the measured temperature**Example**

Mass of water in Measure = 7.062 kg (15.53 lb)

Density of water at 23°C (73.4°F) (ρ_w) = 997.54 kg/m³ (62.274 lb/ft³)

$$V_m = \frac{7.062 \text{ kg}}{997.54 \text{ kg/m}^3} = 0.007079 \text{ m}^3 \quad V_m = \frac{15.53 \text{ lb}}{62.274 \text{ lb/ft}^3} = 0.2494 \text{ ft}^3$$

CONCRETE

WAQTC

FOP AASHTO T 121 (20)

Table A1
Unit Mass of Water
15°C to 30°C

°C	(°F)	kg/m ³	(lb/ft ³)	°C	(°F)	kg/m ³	(lb/ft ³)
15	(59.0)	999.10	(62.372)	23	(73.4)	997.54	(62.274)
15.6	(60.0)	999.01	(62.366)	23.9	(75.0)	997.32	(62.261)
16	(60.8)	998.94	(62.361)	24	(75.2)	997.29	(62.259)
17	(62.6)	998.77	(62.350)	25	(77.0)	997.03	(62.243)
18	(64.4)	998.60	(62.340)	26	(78.8)	996.77	(62.227)
18.3	(65.0)	998.54	(62.336)	26.7	(80.0)	996.59	(62.216)
19	(66.2)	998.40	(62.328)	27	(80.6)	996.50	(62.209)
20	(68.0)	998.20	(62.315)	28	(82.4)	996.23	(62.192)
21	(69.8)	997.99	(62.302)	29	(84.2)	995.95	(62.175)
21.1	(70.0)	997.97	(62.301)	29.4	(85.0)	995.83	(62.166)
22	(71.6)	997.77	(62.288)	30	(86.0)	995.65	(62.156)

Report

- Measure ID
- Date Standardized
- Temperature of the water
- Volume, V_m , of the measure

CONCRETE

WAQTC

FOP AASHTO T 121 (20)

CONCRETE

WAQTC

FOP AASHTO T 121 (17)

PERFORMANCE EXAM CHECKLIST**DENSITY (UNIT WEIGHT), YIELD, AND AIR CONTENT (GRAVIMETRIC) OF
CONCRETE
FOP FOR AASHTO T 121**

Participant Name _____ Exam Date _____

Record the symbols "P" for passing or "F" for failing on each step of the checklist.

Procedure Element	Trial 1	Trial 2
1. Mass and volume of empty measure determined?	_____	_____
First Layer		
2. Dampened measure filled approximately one third full, moving a scoop around the perimeter of the measure to evenly distribute the concrete as discharged?	_____	_____
3. Layer rodded throughout its depth 25 times, without forcibly striking the bottom of the measure, with hemispherical end of rod, uniformly distributing strokes?	_____	_____
4. Perimeter of the measure tapped 10 to 15 times with the mallet after rodding?	_____	_____
Second layer		
5. Measure filled approximately two thirds full, moving a scoop around the perimeter of the measure to evenly distribute the concrete as discharged?	_____	_____
6. Layer rodded throughout its depth, just penetrating the previous layer (approximately 25 mm (1 in.) 25 times with hemispherical end of rod, uniformly distributing strokes?	_____	_____
7. Perimeter of the measure tapped 10 to 15 times with the mallet after rodding?	_____	_____
Third layer		
8. Measure slightly overfilled, moving a scoop around the perimeter of the measure to evenly distribute the concrete as discharged?	_____	_____
9. Layer rodded throughout its depth, just penetrating the previous layer (approximately 25 mm (1 in.) 25 times with hemispherical end of rod, uniformly distributing strokes?	_____	_____
10. Perimeter of the measure tapped 10 to 15 times with the mallet after rodding each layer?	_____	_____
11. Any excess concrete removed using a trowel or a scoop, or small quantity of concrete added to correct a deficiency, after consolidation of final layer?	_____	_____

OVER

Procedure Element

Trial 1 Trial 2

- 12. Strike-off plate placed flat on the measure covering approximately 2/3 of the surface, then sawing action used to withdraw the strike-off plate across the previously covered surface? _____ _____
- 13. Strike-off plate placed flat on the measure covering approximately 2/3 of the surface, then sawing action used to advance the plate across the entire measure surface? _____ _____
- 14. Strike off completed using the inclined edge of the plate creating a smooth surface? _____ _____
- 15. All excess concrete cleaned off and mass of full measure determined? _____ _____
- 16. Concrete mass calculated? _____ _____
- 17. Density calculated correctly? _____ _____

Comments: First attempt: Pass _____ Fail _____ Second attempt: Pass _____ Fail _____

Examiner Signature _____ WAQTC #: _____

This checklist is derived, in part, from copyrighted material printed in ACI CP-1, published by the American Concrete Institute.

WSDOT SOP 128

Sampling for Aggregate Source Approval

1. Scope

This method describes the procedure for sampling pits and quarries for Aggregate Source Approval (ASA).

2. Significance and Use

There are two methods for initiating the process for an ASA:

- a. The source owner/lessee request approval, pays for the sampling and testing, and coordinates this through the ASA Engineer at the State Materials Laboratory who coordinates with the Regions. Sample is obtained by the Region Independent Assurance Inspector (IAI) or a delegate of the Region Materials Engineer (RME).
- b. The aggregate source is sampled and tested as part of a WSDOT project, in which case the WSDOT project pays for the sampling and testing costs which may or may not be coordinated with the ASA process at the State Materials Laboratory. Sample is obtained by the IAI or a delegate of the RME.

3. Safety

All WSDOT employee required to sample from a pit or quarry will contact the pit/quarry owner/lessee or their designated representative prior to arrival at the site and arrange for an escort into the sampling site.

All WSDOT employees will be accompanied by the pit/quarry owner/lessee or their representative during the sampling process.

This standard does not purport to address all of the safety concerns, associated with its use. It is the responsibility of the user of this standard operating procedure to establish a pre-activity safety plan prior to use.

4. Sampling

All samples will be obtained in accordance with WSDOT Errata to FOP for AASHTO R 90.

Stockpiles produced for ASA sampling must contain a minimum of 10 tons of material. The material in the stockpile shall be of the same quality as the final product. If the correct stockpiles are not available for sampling, the inspector will not take a sample and the sampling time will not be refunded.

Sampling location and size of sample is listed in Table 1.

Table 1

Aggregate Type	Sampling Site	Size of Sample in lbs	Notes
Concrete Coarse	Stockpile	50-100	Material must be clean and washed
Concrete Fine	Stockpile	30-40	Material must be clean and washed
Mineral Aggregate (WSDOT Standard Specification 9-03)	Stockpile	80-100	Material must be Crushed Surfacing Base Course - Std. Spec. 9-03.9(3). Samples obtained for quarry spalls may not be used for quality tests for crushed materials.
Quarry Spalls	Face of pit, transport unit or stockpile	50-80	No rock larger than 4" in diameter.
All other Aggregate Types	Face of pit, transport unit or stockpile	50-80	No rock larger than 4" in diameter.

6. Report

The RMEs representative will record the following information in an Inspector's Daily Report (IDR) DOT Form 422-004A:

- Name of Source owner/lessee's Representative accompanying the RME representative during sampling process.
- Time and Date of sampling
- Location including coordinates where the sample is taken (stockpile/pit/face)
- Amount of sample (pounds and number of bags)
- Any concerns of material quality or specific request the owner/lessee's representative may have.

The RME's representative shall take pictures of the following items; a wide view of the mining operation, the sampling location in the pit or quarry, a close-up of the stockpile being sampled and a close-up of the sampled material.

When Sampling is being performed by any group other than WSDOT personnel, sampling shall be witnessed by the WSDOT's representative or Agent. Upon completion of sampling, the sample shall be immediately transferred to the WSDOT's representative or Agent who witnessed the sampling operation. The WSDOT's representative or Agent, to assure chain of custody, will deliver the sample(s) to State Materials Laboratory for testing.

The IDR information and pictures will be e-mailed to the State ASA Engineer.

AIR CONTENT OF FRESHLY MIXED CONCRETE BY THE PRESSURE METHOD FOP FOR AASHTO T 152

Scope

This procedure covers determination of the air content in freshly mixed Portland Cement Concrete containing dense aggregates in accordance with AASHTO T 152-19, Type B meter. It is not for use with lightweight or highly porous aggregates. This procedure includes standardization of the Type B air meter gauge, Annex A.

Warning—Fresh Hydraulic cementitious mixtures are caustic and may cause chemical burns to skin and tissue upon prolonged exposure.

Apparatus

- Air meter: Type B, as described in AASHTO T 152

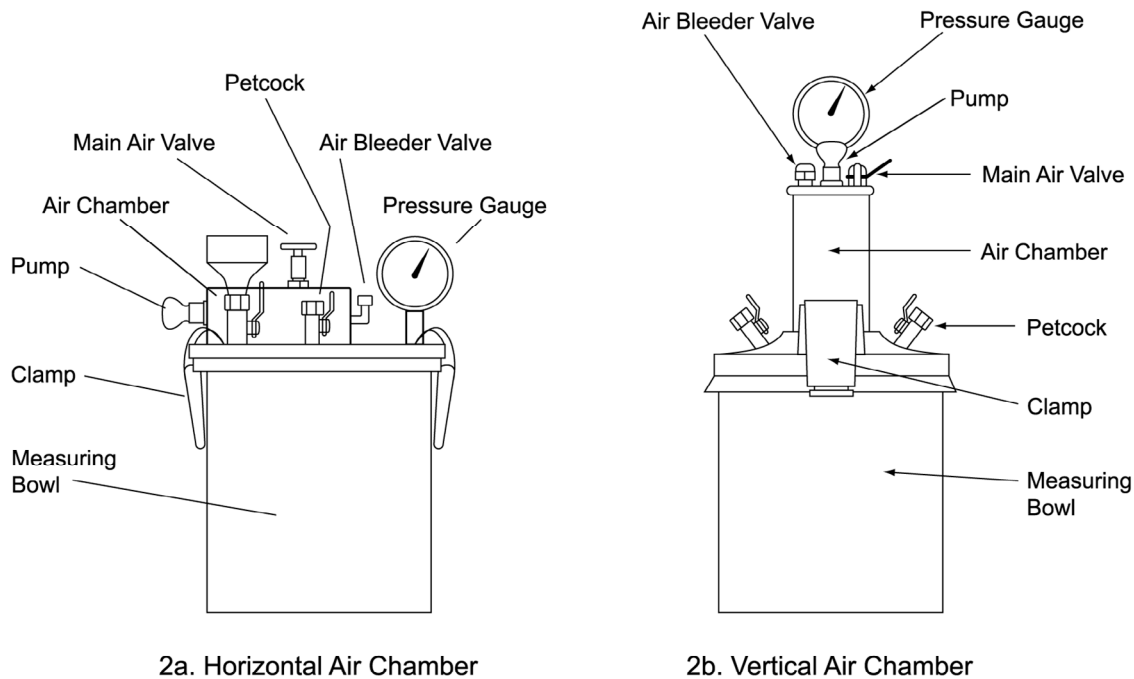

Type B Meter

- Balance or scale: Accurate to 0.3 percent of the test load at any point within the range of use (for Method 1 standardization only)
- Tamping rod: 16 mm (5/8 in.) diameter and 400 mm (16 in.) to 600 mm (24 in.) long, having a hemispherical tip the same diameter as the rod. (Hemispherical means “half a sphere”; the tip is rounded like half of a ball.)

- Vibrator: frequency at least 9000 vibrations per minute (150 Hz), at least 19 to 38 mm (3/4 to 1 1/2 in.) in diameter but not greater than 38 mm (1 1/2 in.), and the length of the shaft shall be at least 75 mm (3 in.) than the depth of the section being vibrated.
- Scoop: a receptacle of appropriate size so that each representative increment of the concrete sample can be placed in the container without spillage.
- Container for water: rubber syringe (may also be a squeeze bottle)
- Strike-off bar: Approximately 300 mm x 22 mm x 3 mm (12 in. x 3/4 in. x 1/8 in.)
- Strike-off plate: A flat rectangular metal plate at least 6 mm (1/4 in.) thick or a glass or acrylic plate at least 12 mm (1/2 in.) thick, with a length and width at least 50 mm (2 in.) greater than the diameter of the measure with which it is to be used. The edges of the plate shall be straight and smooth within tolerance of 1.5 mm (1/16 in.).
Note 1: Use either the strike-off bar or strike-off plate; both are not required.
- Mallet: With a rubber or rawhide head having a mass of 0.57 ± 0.23 kg (1.25 ± 0.5 lb)

Procedure Selection

There are two methods of consolidating the concrete – rodding and vibration. If the slump is greater than 75 mm (3 in.), consolidation is by rodding. When the slump is 25 to 75 mm (1 to 3 in.), internal vibration or rodding can be used to consolidate the sample, but the method used must be that required by the agency in order to obtain consistent, comparable results. For concrete with slumps less than 25 mm (1 in.), consolidate the sample by internal vibration. Do not consolidate self-consolidating concrete (SCC).

Procedure

Sampling

1. Obtain the sample in accordance with the FOP for WAQTC TM 2. If the concrete mixture contains aggregate retained on the 37.5mm (1½ in.) sieve, the aggregate must be removed in accordance with the Wet Sieving portion of the FOP for WAQTC TM 2.

Testing shall begin within five minutes of obtaining the sample.

Rodding

1. Dampen the inside of the air meter measure and place on a firm level surface.
2. Use the scoop to fill the measure approximately 1/3 full with concrete. Evenly distribute the concrete in a circular motion around the inner perimeter of the measure.
3. Consolidate the layer with 25 strokes of the tamping rod, using the rounded end. Distribute the strokes evenly over the entire cross section of the concrete. Rod throughout its depth without hitting the bottom too hard.
4. Tap around the perimeter of the measure smartly 10 to 15 times with the mallet to close voids and release trapped air.

CONCRETE

WAQTC

FOP AASHTO T 152 (22)

5. Add the second layer, filling the measure about 2/3 full. Evenly distribute the concrete in a circular motion around the inner perimeter of the measure.
6. Consolidate this layer with 25 strokes of the tamping rod, penetrating about 25 mm (1 in.) into the bottom layer.
7. Tap around the perimeter of the measure smartly 10 to 15 times with the mallet.
8. Add the final layer, slightly overfilling the measure. Evenly distribute the concrete in a circular motion around the inner perimeter of the measure.
9. Consolidate this layer with 25 strokes of the tamping rod, penetrating about 25 mm (1 in.) into the second layer.
10. Tap around the perimeter of the measure smartly 10 to 15 times with the mallet.
11. After consolidation, the measure should be slightly over full, about 3 mm (1/8 in.) above the rim. If there is a great excess of concrete, remove a portion with the trowel or scoop. If the measure is under full, add a small quantity. This adjustment may be done only after consolidating the final layer and before striking off the surface of the concrete.
12. Continue with 'Strike-off and Air Content.'

Internal Vibration

1. Dampen the inside of the air meter measure and place on a firm level surface.
2. Use the scoop to fill the measure approximately 1/2 full with concrete. Evenly distribute the concrete in a circular motion around the inner perimeter of the measure.
3. Insert the vibrator at three different points. Do not let the vibrator touch the bottom or side of the measure. Remove the vibrator slowly, so that no air pockets are left in the material. Continue vibration only long enough to achieve proper consolidation of the concrete. Over vibration may cause segregation and loss of appreciable quantities of intentionally entrained air.
4. Tap around the perimeter of the measure smartly 10 to 15 times with the mallet.
5. Use the scoop to fill the measure a bit over full. Evenly distribute the concrete in a circular motion around the inner perimeter of the measure.
6. Insert the vibrator at three different points, penetrating the first layer approximately 25 mm (1 in.). Do not let the vibrator touch the side of the measure. Remove the vibrator slowly, so that no air pockets are left in the material. Continue vibration only long enough to achieve proper consolidation of the concrete. Over vibration may cause segregation and loss of appreciable quantities of intentionally entrained air.
7. Tap around the perimeter of the measure smartly 10 to 15 times with the mallet.
8. Continue with 'Strike-off and Air Content.'

Self-Consolidating Concrete

1. Dampen the inside of the air meter measure and place on a firm level surface.
2. Use the scoop to slightly overfill the measure. Evenly distribute the concrete in a circular motion around the inner perimeter of the measure.
3. Continue with 'Strike-off and Air Content.'

Strike-Off and Air Content

1. Strike off the surface of the concrete and finish it smoothly with a sawing action of the strike-off bar or plate, using great care to leave the measure just full. The surface should be smooth and free of voids.
2. Clean the top flange of the measure to ensure a proper seal.
3. Moisten the inside of the cover and check to see that both petcocks are open, and the main air valve is closed.
4. Clamp the cover on the measure.
5. Inject water through a petcock on the cover until water emerges from the petcock on the opposite side. Jar the meter gently until all air is expelled from this same petcock.
6. Verify that water is present in both petcocks.
7. Close the air bleeder valve and pump air into the air chamber until the needle goes past the initial pressure determined for the gauge. Allow a few seconds for the compressed air to cool.
8. Tap the gauge gently with one hand while slowly opening the air bleeder valve until the needle rests on the initial pressure. Close the air bleeder valve.
9. Close both petcocks.
10. Open the main air valve.
11. Tap the side of the measure smartly with the mallet.
12. With the main air valve open, lightly tap the gauge to settle the needle, and then read the air content to the nearest 0.1 percent.
13. Release or close the main air valve.
14. Open both petcocks to release pressure, remove the concrete, and thoroughly clean the cover and measure with clean water.
15. Open the main air valve to relieve the pressure in the air chamber.

CONCRETE

WAQTC

FOP AASHTO T 152 (22)

Report

- On forms approved by the agency
- Sample ID
- Percent of air to the nearest 0.1 percent.
- Some agencies require an aggregate correction factor in order to determine total percent of entrained air.

Total % entrained air = Gauge reading – aggregate correction factor from mix design
(See AASHTO T 152 for more information.)

ANNEX A
STANDARDIZATION OF AIR METER GAUGE

(Mandatory Information)

Standardization is a critical step to ensure accurate test results when using this apparatus. Failure to perform the standardization procedures as described below will produce inaccurate or unreliable test results.

Standardization shall be performed at a minimum of once every three months. Record the date of the standardization, the standardization results, and the name of the technician performing the standardization in the logbook kept with each air meter.

There are two methods for standardizing the air meter, mass or volume, both are covered below.

1. Screw the short piece of straight tubing into the threaded petcock hole on the underside of the cover.
2. Determine and record the mass of the dry, empty air meter measure and cover assembly (mass method only).
3. Fill the measure nearly full with water.
4. Clamp the cover on the measure with the tube extending down into the water. Mark the petcock with the tube attached for future reference.
5. Add water through the petcock having the pipe extension below until all air is forced out the other petcock.
6. Wipe off the air meter measure and cover assembly; determine and record the mass of the filled unit (mass method only).
7. Pump up the air pressure to a little beyond the predetermined initial pressure indicated on the gauge. Wait a few seconds for the compressed air to cool, and then stabilize the gauge hand at the proper initial pressure by pumping up or relieving pressure, as needed.
8. Close both petcocks and immediately open the main air valve exhausting air into the measure. Wait a few seconds until the meter needle stabilizes. The gauge should now read 0 percent. If two or more tests show a consistent variation from 0 percent in the result, change the initial pressure line to compensate for the variation, and use the newly established initial pressure line for subsequent tests.
9. Determine which petcock has the straight tube attached to it. Attach the curved tube to external portion of the same petcock.
10. Pump air into the air chamber. Open the petcock with the curved tube attached to it. Open the main air valve for short periods of time until 5 percent of water by mass or volume has been removed from the air meter. Remember to open both petcocks to release the pressure in the measure and drain the water in the curved tube back into the measure. To determine the mass of the water to be removed, subtract the mass found in Step 2 from the mass found in Step 6. Multiply this value by 0.05. This is the mass of the water that must be removed. To remove 5 percent by volume, remove water until the external standardization vessel is level full.

Note A1: Many air meters are supplied with a standardization vessel(s) of known volume that are used for this purpose. Standardization vessel must be protected from crushing or denting. If an external standardization vessel is used, confirm what percentage volume it represents for the air meter being used. Vessels commonly represent 5 percent volume, but they are for specific size meters. This should be confirmed by mass.

11. Remove the curved tube. Pump up the air pressure to a little beyond the predetermined initial pressure indicated on the gauge. Wait a few seconds for the compressed air to cool, and then stabilize the gauge hand at the proper initial pressure by pumping up or relieving pressure, as needed.
12. Close both petcocks and immediately open the main air valve exhausting air into the measure. Wait a few seconds until the meter needle is stabilized. The gauge should now read 5.0 ± 0.1 percent. If the gauge is outside that range, the meter needs adjustment. The adjustment could involve adjusting the starting point so that the gauge reads 5.0 ± 0.1 percent when this standardization is run or could involve moving the gauge needle to read 5.0 percent. Any adjustment should comply with the manufacturer's recommendations.
13. When the gauge hand reads correctly at 5.0 percent, additional water may be withdrawn in the same manner to check the results at other values such as 10 percent or 15 percent.
14. If an internal standardization vessel is used, follow Steps 1 through 8 to set initial reading.
15. Release pressure from the measure and remove cover. Place the internal standardization vessel into the measure. This will displace 5 percent of the water in the measure. (See AASHTO T 152 for more information on internal standardization vessels.)
16. Place the cover back on the measure and add water through the petcock until all the air has been expelled.
17. Pump up the air pressure chamber to the initial pressure. Wait a few seconds for the compressed air to cool, and then stabilize the gauge hand at the proper initial pressure by pumping up or relieving pressure, as needed.
18. Close both petcocks and immediately open the main air valve exhausting air into the measure. Wait a few seconds until the meter needle stabilizes. The gauge should now read 5 percent.
19. Remove the extension tubing from threaded petcock hole in the underside of the cover before starting the test procedure.

Report

- Air meter ID
- Date standardized
- Initial pressure (IP)

CONCRETE

WAQTC

FOP AASHTO T 152 (22)

CONCRETE

WAQTC

FOP AASHTO T 152 (22)

PERFORMANCE EXAM CHECKLIST**AIR CONTENT OF FRESHLY MIXED CONCRETE BY THE PRESSURE METHOD
FOP FOR AASHTO T 152**

Participant Name _____ Exam Date _____

Record the symbols "P" for passing or "F" for failing on each step of the checklist.

Procedure Element	Trial 1	Trial 2
1. Representative sample selected?	_____	_____
First Layer		
2. Dampened measure filled approximately one third full, moving a scoop around the perimeter of the measure to evenly distribute the concrete as discharged?	_____	_____
3. Layer rodded throughout its depth 25 times, without forcibly striking the bottom of the measure, with hemispherical end of rod, uniformly distributing strokes?	_____	_____
4. Perimeter of the measure tapped 10 to 15 times with the mallet after rodding?	_____	_____
Second layer		
5. Measure filled approximately two thirds full, moving a scoop around the perimeter of the measure to evenly distribute the concrete as discharged?	_____	_____
6. Layer rodded throughout its depth, just penetrating the previous layer (approximately 25 mm (1 in.)) 25 times with hemispherical end of rod, uniformly distributing strokes?	_____	_____
7. Perimeter of the measure tapped 10 to 15 times with the mallet after rodding?	_____	_____
Third layer		
8. Measure slightly overfilled, moving a scoop around the perimeter of the measure to evenly distribute the concrete as discharged?	_____	_____
9. Layer rodded throughout its depth, just penetrating the previous layer (approximately 25 mm (1 in.)) 25 times with hemispherical end of rod, uniformly distributing strokes?	_____	_____
10. Perimeter of the measure tapped 10 to 15 times with the mallet after rodding each layer?	_____	_____
11. Concrete struck off level with top of the measure using the bar or strike-off plate and rim cleaned off?	_____	_____
12. Top flange of base cleaned?	_____	_____

OVER

CONCRETE

WAQTC

FOP AASHTO T 152 (22)

Procedure Element

Trial 1 Trial 2

Using a Type B Meter:

- 13. Both petcocks open? _____
- 14. Air valve closed between air chamber and the measure? _____
- 15. Inside of cover cleaned and moistened before clamping to base? _____
- 16. Water injected through petcock until it flows out the other petcock? _____
- 17. Meter jarred gently until all air is expelled? _____
- 18. Water is present in both petcocks? _____
- 19. Air pumped up to just past initial pressure line? _____
- 20. A few seconds allowed for the compressed air to stabilize? _____
- 21. Gauge adjusted to the initial pressure? _____
- 22. Both petcocks closed? _____
- 23. Air valve opened between chamber and measure? _____
- 24. The outside of measure tapped smartly with the mallet? _____
- 25. With the main air valve open, gauge lightly tapped and air percentage read to the nearest 0.1 percent? _____
- 26. Air valve released or closed and then petcocks opened to release pressure before removing the cover? _____
- 27. Aggregate correction factor applied if required? _____
- 28. Air content recorded to 0.1 percent? _____

Comments: First attempt: Pass _____ Fail _____ Second attempt: Pass _____ Fail _____

Examiner Signature _____ WAQTC #: _____

This checklist is derived, in part, from copyrighted material printed in ACI CP-1, published by the American Concrete Institute.

BULK SPECIFIC GRAVITY (G_{mb}) OF COMPACTED ASPHALT MIXTURES USING SATURATED SURFACE-DRY SPECIMENS FOP FOR AASHTO T 166

Scope

This procedure covers the determination of bulk specific gravity (G_{mb}) of compacted asphalt mixtures using three methods – A, B, and C – in accordance with AASHTO T 166-22. This FOP is for use on specimens not having open or interconnecting voids or absorbing more than 2.00 percent water by volume, or both. When specimens have open or interconnecting voids or absorbing more than 2.00 percent water by volume, or both, AASHTO T 275 or AASHTO T 331 should be performed.

Overview

- Method A: Suspension
- Method B: Volumeter
- Method C: Rapid test for A or B

Test Specimens

Test specimens may be either laboratory-molded or sampled from asphalt mixture pavement. For specimens it is recommended that the diameter be equal to four times the maximum size of the aggregate and the thickness be at least one and one half times the maximum size.

Terminology

Constant Mass: The state at which a mass does not change more than a given percent, after additional drying for a defined time interval, at a required temperature.

Apparatus – Method A (Suspension)

- Balance or scale: 5 kg capacity, readable to 0.1 g, and fitted with a suitable suspension apparatus and holder to permit weighing the specimen while suspended in water, conforming to AASHTO M 231.
- Suspension apparatus: Wire of the smallest practical size and constructed to permit the container to be fully immersed.
- Water bath: For immersing the specimen in water while suspended under the balance or scale and equipped with an overflow outlet for maintaining a constant water level.
- Towel: Damp cloth towel used for surface drying specimens.
- Oven: Capable of maintaining a temperature of $52 \pm 3^{\circ}\text{C}$ ($126 \pm 5^{\circ}\text{F}$) for drying the specimens to a constant mass.

- Pan: Pan or other suitable container of known mass, large enough to hold a sample for drying in oven.
- Thermometer: Having a range of 15 to 45°C (59 to 113°F) and, graduated in 0.1°C (0.2°F) subdivisions.
- Vacuum device: refer to the FOP for AASHTO R 79 (optional)

Procedure – Method A (Suspension)

Recently molded laboratory samples that have not been exposed to moisture do not need drying.

1. Dry the specimen to constant mass, if required.
 - a. Oven method
 - i. Initially dry overnight at $52 \pm 3^{\circ}\text{C}$ ($125 \pm 5^{\circ}\text{F}$).
 - ii. Determine and record the mass of the specimen. Designate this mass as M_p .
 - iii. Return the specimen to the oven for at least 2 hours.
 - iv. Determine and record the mass of the specimen. Designate this mass as M_n .
 - v. Determine percent change by subtracting the new mass determination, M_n , from the previous mass determination, M_p , divide by the previous mass determination M_p , and multiply by 100.
 - vi. Continue drying until there is no more than 0.05 percent change in specimen mass after 2-hour drying intervals (constant mass).
 - vii. Constant mass has been achieved; sample is defined as dry.
 - b. Vacuum dry method according to the FOP for AASHTO R 79.
2. Cool the specimen in air to $25 \pm 5^{\circ}\text{C}$ ($77 \pm 9^{\circ}\text{F}$), and determine and record the dry mass to the nearest 0.1 g. Designate this mass as A.
3. Fill the water bath to overflow level with water at $25 \pm 1^{\circ}\text{C}$ ($77 \pm 2^{\circ}\text{F}$) and allow the water to stabilize.
4. Zero or tare the balance with the immersion apparatus attached, ensuring that the device is not touching the sides or the bottom of the water bath.
5. Immerse the specimen shaking to remove the air bubbles. Place the specimen on its side in the suspension apparatus. Leave it immersed for 4 ± 1 minutes.
6. Determine and record the submerged weight to the nearest 0.1 g. Designate this submerged weight as C.
7. Remove the sample from the water and quickly surface dry with a damp cloth towel within 5 seconds.

ASPHALT

WAQTC

FOP AASHTO T 166 (22)

8. Zero or tare the balance.
9. Immediately determine and record the mass of the saturated surface-dry (SSD) specimen to nearest 0.1 g. Designate this mass as B. Any water that seeps from the specimen during the mass determination is considered part of the saturated specimen. Do not exceed 15 seconds performing Steps 7 through 9.

Calculations – Method A (Suspension)

Constant Mass:

Calculate constant mass using the following formula:

$$\%Change = \frac{M_p - M_n}{M_p} \times 100$$

Where:

M_p = previous mass measurement, g

M_n = new mass measurement, g

Bulk specific gravity (G_{mb}) and percent water absorbed:

$$G_{mb} = \frac{A}{B - C}$$

$$\text{Percent Water Absorbed (by volume)} = \frac{B - A}{B - C} \times 100$$

Where:

G_{mb} = Bulk specific gravity

A = Mass of dry specimen in air, g

B = Mass of SSD specimen in air, g

C = Weight of specimen in water at $25 \pm 1^\circ\text{C}$ ($77 \pm 2^\circ\text{F}$), g

Example:

$$G_{mb} = \frac{4833.6 \text{ g}}{4842.4 \text{ g} - 2881.3 \text{ g}} = 2.465$$

$$\% \text{ Water Absorbed (by volume)} = \frac{4842.4 \text{ g} - 4833.6 \text{ g}}{4842.4 \text{ g} - 2881.3 \text{ g}} \times 100 = 0.45\%$$

Given:

A	=	4833.6 g
B	=	4842.4 g
C	=	2881.3 g

Apparatus – Method B (Volumeter)

- Balance or scale: 5 kg capacity, readable to 0.1 g and conforming to AASHTO M 231.
- Water bath: For immersing the specimen in water, capable of maintaining a uniform temperature at $25 \pm 1^\circ\text{C}$ ($77 \pm 2^\circ\text{F}$).
- Thermometer: Range of 15 to 45°C (59 to 113°F) and graduated in 0.1°C (0.2°F) subdivisions.
- Volumeter: Calibrated to 1200 mL or appropriate capacity for test sample and having a tapered lid with a capillary bore.
- Oven: Capable of maintaining a temperature of $52 \pm 3^\circ\text{C}$ ($126 \pm 5^\circ\text{F}$). for drying the specimens to a constant mass.
- Pan: Pan or other suitable container of known mass, large enough to hold a sample for drying in oven.
- Towel: Damp cloth towel used for surface drying specimens.
- Vacuum device: refer to the FOP for AASHTO R 79 (optional)

Procedure – Method B (Volumeter)

Recently molded laboratory samples that have not been exposed to moisture do not need drying.

1. Dry the specimen to constant mass, if required.
 - a. Oven method:
 - i. Initially dry overnight at $52 \pm 3^{\circ}\text{C}$ ($125 \pm 5^{\circ}\text{F}$).
 - ii. Determine and record the mass of the specimen. Designate this mass as M_p .
 - iii. Return the specimen to the oven for at least 2 hours.
 - iv. Determine and record the mass of the specimen. Designate this mass as M_n .
 - v. Determine percent change by subtracting the new mass determination, M_n , from the previous mass determination, M_p , divide by the previous mass determination, M_p , and multiply by 100.
 - vi. Continue drying until there is no more than 0.05 percent change in specimen mass after 2-hour drying intervals (constant mass).
 - vii. Constant mass has been achieved; sample is defined as dry.

Note 1: To expedite the procedure, steps 1 and 2 may be performed last. To further expedite the process, see Method C.

- b. Vacuum dry method according to the FOP for AASHTO R 79.
2. Cool the specimen in air to $25 \pm 5^{\circ}\text{C}$ ($77 \pm 9^{\circ}\text{F}$), and determine and record the dry mass to the nearest 0.1 g. Designate this mass as A.
3. Immerse the specimen in the temperature-controlled water bath at $25 \pm 1^{\circ}\text{C}$ ($77 \pm 2^{\circ}\text{F}$) for at least 10 minutes.
4. At the end of the ten-minute period, fill the volumeter with distilled water at $25 \pm 1^{\circ}\text{C}$ ($77 \pm 2^{\circ}\text{F}$) making sure some water escapes through the capillary bore of the tapered lid.
5. Wipe the volumeter dry. Determine the mass of the volumeter and water to the nearest 0.1 g. Designate this mass as D.
6. Remove the specimen from the water bath and quickly surface dry with a damp cloth towel within 5 seconds.
7. Immediately determine and record the mass of the SSD specimen to the nearest 0.1 g. Designate this mass as B. Any water that seeps from the specimen during the mass determination is considered part of the saturated specimen.
8. Place the specimen in the volumeter and let stand 60 seconds.
9. Bring the temperature of the water to $25 \pm 1^{\circ}\text{C}$ ($77 \pm 2^{\circ}\text{F}$) and cover the volumeter, making sure some water escapes through the capillary bore of the tapered lid.
10. Wipe the volumeter dry.
11. Determine and record the mass of the volumeter, water, and specimen to the nearest 0.1 g. Designate this mass as E.

Note 2: Method B is not acceptable for use with specimens that have more than 6 percent air voids.

Calculations – Method B (Volumeter)

Constant Mass:

Calculate constant mass using the following formula:

$$\%Change = \frac{M_p - M_n}{M_p} \times 100$$

Where:

M_p = previous mass measurement, g

M_n = new mass measurement, g

Bulk specific gravity (G_{mb}) and percent water absorbed:

$$G_{mb} = \frac{A}{B + D - E}$$

$$\text{Percent Water Absorbed (by volume)} = \frac{B - A}{B + D - E} \times 100$$

Where:

G_{mb} = Bulk specific gravity

A = Mass of dry specimen in air, g

B = Mass of SSD specimen in air, g

D = Mass of volumeter filled with water at $25 \pm 1^\circ\text{C}$ ($77 \pm 2^\circ\text{F}$), g

E = Mass of volumeter filled with specimen and water, g

ASPHALT

WAQTC

FOP AASHTO T 166 (22)

Example:

$$G_{mb} = \frac{4833.6 \text{ g}}{4842.4 \text{ g} + 2924.4 \text{ g} - 5806.0 \text{ g}} = 2.465$$

$$\% \text{ Water Absorbed (by volume)} = \frac{4842.4 \text{ g} - 4833.6 \text{ g}}{4842.4 \text{ g} + 2924.4 \text{ g} - 5806.0 \text{ g}} \times 100 = 0.45\%$$

Given:

A	=	4833.6 g
B	=	4842.4 g
D	=	2924.4 g
E	=	5806.0 g

Apparatus – Method C (Rapid Test for Method A or B)

- Oven: Capable of maintaining a temperature of $110 \pm 5^{\circ}\text{C}$ ($230 \pm 9^{\circ}\text{F}$) for drying the specimens to a constant mass.

See Methods A or B.

Note 3: This procedure can be used for specimens that are not required to be saved and contain substantial amounts of moisture. Cores can be tested the same day as obtained by this method.

Procedure – Method C (Rapid Test for Method A or B)

1. Start on Step 3 of Method A or B, and complete that procedure, then determine dry mass, A, as follows.
2. Determine and record mass of a large, flat-bottom container.
3. Place the specimen in the container.
4. Place in an oven at $110 \pm 5 \text{ C}$ ($230 \pm 9 \text{ F}$).
5. Dry until the specimen can be easily separated into fine aggregate particles that are not larger than 6.3 mm ($\frac{1}{4}$ in.).
6. Determine and record the mass of the specimen. Designate this mass as M_p .
7. Return the specimen to the oven for at least 2 hours.
8. Determine and record the mass of the specimen. Designate this mass as M_n .

ASPHALT

WAQTC

FOP AASHTO T 166 (22)

9. Determine percent change by subtracting the new mass determination, M_n , from the previous mass determination, M_p , divide by the previous mass determination, M_p , and multiply by 100.
10. Continue drying until there is no more than 0.05 percent change in specimen mass after 2-hour drying intervals (constant mass).
11. Constant mass has been achieved; sample is defined as dry.
12. Cool in air to $25 \pm 5^\circ\text{C}$ ($77 \pm 9^\circ\text{F}$).
13. Determine and record the mass of the container and dry specimen to the nearest 0.1 g.
14. Determine and record the mass of the dry specimen to the nearest 0.1 g by subtracting the mass of the container from the mass determined in Step 13. Designate this mass as A.

Calculations – Method C (Rapid Test for Method A or B)

Complete the calculations as outlined in Methods A or B, as appropriate.

Report

- On forms approved by the agency
- Sample ID
- G_{mb} to the nearest 0.001
- Absorption to the nearest 0.01 percent
- Method performed.

PERFORMANCE EXAM CHECKLIST

BULK SPECIFIC GRAVITY OF COMPACTED ASPHALT MIXTURES USING SATURATED SURFACE-DRY SPECIMENS FOP FOR AASHTO T 166

Participant Name _____ Exam Date _____

Record the symbols “P” for passing or “F” for failing on each step of the checklist.

Procedure Element	Trial 1	Trial 2
Method A:		
1. Mass of dry sample determined.		
a. Sample dried to constant mass if required?	_____	_____
b. Cooled in air to 25 ±5°C (77 ±9°F)?	_____	_____
c. Dry mass determined to 0.1g?	_____	_____
2. Water at the overflow?	_____	_____
3. Balance zeroed?	_____	_____
4. Immersed weight determined.		
a. Water at 25 ±1°C (77 ±2°F)?	_____	_____
b. Immersed, shaken, on side, for 4 ±1 min.?	_____	_____
c. Immersed weight determined to 0.1g?	_____	_____
5. Sample rapidly surface dried with damp towel and saturated surface dry (SSD) mass determined to 0.1 g (entire operation performed within 15 seconds)?	_____	_____
6. G_{mb} calculated to the nearest 0.001?	_____	_____
7. Absorption calculated to the nearest 0.01 percent	_____	_____

OVER

ASPHALT

WAQTC

FOP AASHTO T 166 (22)

Procedure Element**Trial 1 Trial 2****Method B:**

- | | | |
|--|-------|-------|
| 1. Specimen dried, cooled, and mass determined as in Method A? | _____ | _____ |
| 2. Saturated surface-dry (SSD) mass determined to 0.1g. | | |
| a. Immersed at least 10 minutes at 25 ±1°C (77 ±2°F)? | _____ | _____ |
| b. Sample rapidly dried with damp towel? | _____ | _____ |
| c. Specimen mass determined to 0.1 g? | _____ | _____ |
| d. Any water that seeps from specimen included in mass? | _____ | _____ |
| 3. Mass of volumeter filled with distilled water at 25 ±1°C (77 ±2°F) determined? | _____ | _____ |
| 4. SSD specimen placed into volumeter and let stand for 1 minute? | _____ | _____ |
| 5. Temperature of water brought to 25 ±1°C (77 ±2°F) and volumeter covered, allowing some water to escape through the capillary bore of the tapered lid? | _____ | _____ |
| 6. Volumeter wiped dry, and mass of volumeter and contents determined? | _____ | _____ |
| 7. G_{mb} calculated to the nearest 0.001? | _____ | _____ |
| 8. Absorption calculated to the nearest 0.01 percent? | _____ | _____ |

Method C/A:

- | | | |
|---|-------|-------|
| 1. Immersed weight determined. | | |
| a. Water at 25 ±1°C (77 ±2°F)? | _____ | _____ |
| b. Immersed, shaken, on side, for 4 ±1 minutes? | _____ | _____ |
| c. Immersed weight determined to 0.1 g? | _____ | _____ |
| 2. Sample rapidly surface dried with damp cloth (within 5 seconds)? | _____ | _____ |
| 3. Saturated surface dry mass determined to 0.1 g? | _____ | _____ |
| 4. Dry mass determined by: | | |
| a. Heating in oven at 110 ± 5 C (230 ± 9 F)? | _____ | _____ |
| b. Breaking down to 6.3 mm (¼ in.) particles? | _____ | _____ |
| c. Drying in oven to constant mass (change less than 0.05 percent in 2 hours of additional drying)? | _____ | _____ |
| d. Cooled in air to 25 ±5°C (77 ±9°F) and mass determined to 0.1 g? | _____ | _____ |
| 5. G_{mb} calculated to the nearest 0.001? | _____ | _____ |
| 6. Absorption calculated to the nearest 0.01? | _____ | _____ |

OVER

ASPHALT

WAQTC

FOP AASHTO T 166 (22)

Procedure Element

Trial 1 Trial 2

Method C/B:

- 1. Saturated surface-dry (SSD) mass determined to 0.1g.
 - a. Immersed at least 10 minutes at 25 ±1°C (77 ±2°F)?
 - b. Sample rapidly dried with damp towel (within 5 seconds)?
 - c. Specimen mass determined to 0.1g?
 - d. Any water that seeps from specimen included in mass?
- 2. Mass of volumeter filled with distilled water at 25 ±1°C (77 ±2°F) determined to 0.1 g?
- 3. SSD specimen placed into volumeter and let stand for 1 minute?
- 4. Temperature of water brought to 25 ±1°C (77 ±2°F) and volumeter covered, allowing some water to escape through the capillary pore of the tapered lid?
- 5. Volumeter wiped dry, and mass of volumeter and contents determined to 0.1 g?
- 6. Dry mass determined by:
 - a. Heating in oven at 110 ± 5 C (230 ± 9 F)?
 - b. Breaking down to 6.3 mm (¼ in.) particles?
 - c. Drying in oven to constant mass (change less than 0.05 percent in 2 hours of additional drying)?
 - d. Cooled in air to 25 ±5°C (77 ±9°F) and mass determined to 0.1 g?
- 7. G_{mb} calculated to the nearest 0.001?
- 8. Absorption calculated to the nearest 0.01 percent?

Comments: First attempt: Pass Fail Second attempt: Pass Fail

Examiner Signature _____ WAQTC #: _____

ASPHALT

WAQTC

FOP AASHTO T 166 (22)

WSDOT Errata to FOP for AASHTO T 176

Plastic Fines in Graded Aggregates and Soils by the Use of the Sand Equivalent Test

WAQTC FOP for AASHTO T 176 has been adopted by WSDOT with the following changes:

Sample Preparation

Replace step 7 with below:

7. WSDOT requires two samples.

Include step 8 below:

8. Dry the two test samples in an oven in accordance with FOP for AASHTO T 255. The oven temperature shall not exceed 350°F (177°C). Cool to room temperature before testing. It is acceptable to place the test sample in a larger container to aid drying.

Procedure

6. After loosening the material from the bottom of the cylinder, shake the cylinder and contents by any one of the following methods:
 - c. Hand Method – Method not recognized by WSDOT.
10. Clay and sand readings:

Replace step d with below:

- e. If two Sand Equivalent (SE) samples are run on the same material and the second varies by more than ± 8 , based on the first cylinder result, additional tests shall be run.
- f. Step not required by WSDOT

PLASTIC FINES IN GRADED AGGREGATES AND SOILS BY THE USE OF THE SAND EQUIVALENT TEST FOP FOR AASHTO T 176

Scope

This procedure covers the determination of plastic fines in accordance with AASHTO T 176-22. It serves as a rapid test to show the relative proportion of fine dust or clay-like materials in fine aggregates (FA) and soils.

Apparatus

See AASHTO T 176 for a detailed listing of sand equivalent apparatus. Note that the siphon tube and blow tube may be glass or stainless steel as well as copper.

- Graduated plastic cylinder.
- Rubber stopper.
- Irrigator tube.
- Weighted foot assembly: Having a mass of 1000 ± 5 g. There are two models of the weighted foot assembly. The older model has a guide cap that fits over the upper end of the graduated cylinder and centers the rod in the cylinder. It is read using a slot in the centering screws. The newer model has a sand-reading indicator 254 mm (10 in.) above this point and is preferred for testing clay-like materials.
- Bottle: clean, glass or plastic, of sufficient size to hold working solution
- Siphon assembly: The siphon assembly will be fitted to a 4 L (1 gal.) bottle of working calcium chloride solution placed on a shelf 915 ± 25 mm (36 ± 1 in.) above the work surface.
- Measuring can: With a capacity of 85 ± 5 mL (3 oz.).
- Balance or scale: Capacity sufficient for sample mass, accurate to 0.1 percent of the sample mass or readable to 0.1 g and meeting the requirements of AASHTO M 231.
- Funnel: With a wide mouth for transferring sample into the graduated cylinder.
- Quartering cloth: 600 mm (2 ft.) square nonabsorbent cloth, such as plastic or oilcloth.
- Mechanical splitter: See the FOP for AASHTO R 76.
- Strike-off bar: A straightedge or spatula.
- Clock or watch reading in minutes and seconds.
- Manual shaker: A manually operated sand equivalent shaker capable of producing an oscillating motion at a rate of 100 complete cycles in 45 ± 5 seconds, with a hand assisted half stroke length of 127 ± 5 mm (5 ± 0.2 in.). It may be held stable by hand during the shaking operation. It is recommended that this shaker be fastened securely to a firm and level mount, by bolts or clamps, if many determinations are to be made.

- Mechanical shaker: See AASHTO T 176 for equipment and procedure.
- Oven: Capable of maintaining a temperature of $110 \pm 5^{\circ}\text{C}$ ($230 \pm 9^{\circ}\text{F}$).
- Thermometer: Calibrated liquid-in-glass or electronic digital type designed for total immersion and accurate to 0.1°C (0.2°F).
- Sieve: 4.75-mm (No. 4) sieve meeting the requirements of the FOP for AASHTO T 27/T 11

Materials

- Stock calcium chloride solution: Obtain commercially prepared calcium chloride stock solution meeting AASHTO requirements.
- Working calcium chloride solution: Make 3.8 L (1 gal) of working solution. Fill the bottle with 2 L (1/2 gal) of distilled or demineralized water, add one 3 oz. measuring can (85 ± 5 mL) of stock calcium chloride solution. Agitate vigorously for 1 to 2 minutes. Add the remainder of the water, approximately 2 L (1/2 gal.) for a total of 3.8 L (1 gal) of working solution. Repeat the agitation process. Tap water may be used if it is proven to be non-detrimental to the test and if it is allowed by the agency. The shelf life of the working solution is approximately 30 days. Label working solution with the date mixed. Discard working solutions more than 30 days old.

Note 1: The graduated cylinder filled to 4.4 in. contains 88 mL and may be used to measure the stock solution.

Control

The temperature of the working solution should be maintained at $22 \pm 3^{\circ}\text{C}$ ($72 \pm 5^{\circ}\text{F}$) during the performance of the test. If field conditions preclude the maintenance of the temperature range, reference samples should be submitted to the Central/Regional Laboratory, as required by the agency, where proper temperature control is possible. Samples that meet the minimum sand equivalent requirement at a working solution temperature outside of the temperature range need not be subject to reference testing.

Sample Preparation

1. Obtain the sample in accordance with the FOP for AASHTO R 90 and reduce in accordance with the FOP for AASHTO R 76.
2. Sieve the sample over the 4.75 mm (No. 4) sieve. If the material is in clods, break it up and re-screen it over a 4.75 mm (No. 4) sieve. Clean all fines from particles retained on the 4.75 mm (No. 4) sieve and include with the material passing that sieve.
3. Split or quarter 1000 to 1500 g of material from the portion passing the 4.75 mm (No. 4) sieve. Use extreme care to obtain a truly representative portion of the original sample.

Note 2: Experiments show that, as the amount of material being reduced by splitting or quartering is decreased, the accuracy of providing representative portions is reduced. It is imperative that the sample be split or quartered carefully. When it appears necessary, dampen the material before splitting or quartering to avoid segregation or loss of fines.

Note 3: All tests, including reference tests, will be performed using Alternative Method No. 2 as described in AASHTO T 176, unless otherwise specified.

4. The sample must have the proper moisture content to achieve reliable results. This condition is determined by tightly squeezing a small portion of the thoroughly mixed sample in the palm of the hand. If the cast that is formed permits careful handling without breaking, the correct moisture content has been obtained.

Note 4: Clean sands having little 75 μm (No. 200), such as sand for Portland Cement Concrete (PCC), may not form a cast.

If the material is too dry, the cast will crumble, and it will be necessary to add water and remix and retest until the material forms a cast. When the moisture content is altered to provide the required cast, the altered sample should be placed in a pan, covered with a lid or with a damp cloth that does not touch the material, and allowed to stand for a minimum of 15 minutes. Samples that have been sieved without being air-dried and still retain enough natural moisture are exempted from this requirement.

If the material shows any free water, it is too wet to test and must be drained and air dried. Mix frequently to ensure uniformity. This drying process should continue until squeezing provides the required cast.

5. Place the sample on the quartering cloth and mix by alternately lifting each corner of the cloth and pulling it over the sample toward the diagonally opposite corner, being careful to keep the top of the cloth parallel to the bottom, thus causing the material to be rolled. When the material appears homogeneous, finish the mixing with the sample in a pile near the center of the cloth.
6. Fill the measuring can by pushing it through the base of the pile while exerting pressure with the hand against the pile on the side opposite the measuring can. As the can is moved through the pile, hold enough pressure with the hand to cause the material to fill the tin to overflowing. Press firmly with the palm of the hand, compacting the material and placing the maximum amount in the can. Strike off the can level with the straightedge or spatula.
7. When required, repeat steps 5 and 6 to obtain additional samples.

Procedure

1. Start the siphon by forcing air into the top of the solution bottle through the tube while the pinch clamp is open. Siphon 101.6 \pm 2.5 mm (4 \pm 0.1 in.) of working calcium chloride solution into the plastic cylinder.
2. Pour the prepared test sample from the measuring can into the plastic cylinder, using the funnel to avoid spilling.
3. Tap the bottom of the cylinder sharply on the heel of the hand several times to release air bubbles and to promote thorough wetting of the sample.
4. Allow the wetted sample to stand undisturbed for 10 \pm 1 minutes.
5. At the end of the 10-minute period, stopper the cylinder and loosen the material from the bottom by simultaneously partially inverting and shaking the cylinder.

6. After loosening the material from the bottom of the cylinder, shake the cylinder and contents by any one of the following methods:
 - a. Mechanical Method – Place the stoppered cylinder in the mechanical shaker, set the timer, and allow the machine to shake the cylinder and contents for 45 ± 1 seconds.

Caution: Agencies may require additional operator qualifications for the next two methods.

- b. Manual Method – Secure the stoppered cylinder in the three spring clamps on the carriage of the manually-operated sand equivalent shaker and set the stroke counter to zero. Stand directly in front of the shaker and force the pointer to the stroke limit marker painted on the backboard by applying an abrupt horizontal thrust to the upper portion of the right hand spring strap.

Remove the hand from the strap and allow the spring action of the straps to move the carriage and cylinder in the opposite direction without assistance or hindrance. Apply enough force to the right-hand spring steel strap during the thrust portion of each stroke to move the pointer to the stroke limit marker by pushing against the strap with the ends of the fingers to maintain a smooth oscillating motion. The center of the stroke limit marker is positioned to provide the proper stroke length and its width provides the maximum allowable limits of variation.

Proper shaking action is accomplished when the tip of the pointer reverses direction within the marker limits. Proper shaking action can best be maintained by using only the forearm and wrist action to propel the shaker. Continue shaking for 100 strokes.

- c. Hand Method – Hold the cylinder in a horizontal position and shake it vigorously in a horizontal linear motion from end to end. Shake the cylinder 90 cycles in approximately 30 seconds using a throw of $229 \text{ mm} \pm 25 \text{ mm}$ ($9 \pm 1 \text{ in.}$). A cycle is defined as a complete back and forth motion. To properly shake the cylinder at this speed, it will be necessary for the operator to shake with the forearms only, relaxing the body and shoulders.
7. Set the cylinder upright on the worktable and remove the stopper.
8. Insert the irrigator tube in the cylinder and rinse material from the cylinder walls as the irrigator is lowered. Force the irrigator through the material to the bottom of the cylinder by applying a gentle stabbing and twisting action while the working solution flows from the irrigator tip. Work the irrigator tube to the bottom of the cylinder as quickly as possible as it becomes more difficult to do this as the washing proceeds. This flushes the fine material into suspension above the coarser sand particles.

Continue to apply a stabbing and twisting action while flushing the fines upward until the cylinder is filled to the 381 mm (15 in.) mark. Then raise the irrigator slowly without shutting off the flow so that the liquid level is maintained at about 381 mm (15 in.) while the irrigator is being withdrawn. Regulate the flow just before the irrigator is entirely withdrawn and adjust the final level to 381 mm (15 in.).

Note 5: Occasionally the holes in the tip of the irrigator tube may become clogged by a particle of sand. If the obstruction cannot be freed by any other method, use a pin or other sharp object to force it out, using extreme care not to enlarge the size of the opening. Also, keep the tip sharp as an aid to penetrating the sample.

9. Allow the cylinder and contents to stand undisturbed for 20 minutes \pm 15 seconds. Start timing immediately after withdrawing the irrigator tube.

Note 6: Any vibration or movement of the cylinder during this time will interfere with the normal settling rate of the suspended clay and will cause an erroneous result.

10. Clay and sand readings:

- a. At the end of the 20-minute sedimentation period, read and record the level of the top of the clay suspension. This is referred to as the clay reading.
- b. If no clear line of demarcation has formed at the end of the 20-minute sedimentation period, allow the sample to stand undisturbed until a clay reading can be obtained, then immediately read and record the level of the top of the clay suspension and the total sedimentation time. If the total sedimentation time exceeds 30 minutes, rerun the test using three individual samples of the same material. Read and record the clay column height of the sample requiring the shortest sedimentation period only. Once a sedimentation time has been established, subsequent tests will be run using that time. The time will be recorded along with the test results on all reports.
- c. After the clay reading has been taken, place the weighted foot assembly over the cylinder and gently lower the assembly until it comes to rest on the sand. Do not allow the indicator to hit the mouth of the cylinder as the assembly is being lowered. Subtract 254 mm (10 in.) from the level indicated by the extreme top edge of the indicator and record this value as the sand reading.
- d. If clay or sand readings fall between 2.5 mm (0.1 in.) graduations, record the level of the higher graduation as the reading. For example, a clay reading that appears to be 7.95 would be recorded as 8.0; a sand reading that appears to be 3.22 would be recorded as 3.3.
- e. If two Sand Equivalent (SE) samples are run on the same material and the second varies by more than \pm 4, based on the first cylinder result, additional tests shall be run.
- f. If three or more Sand Equivalent (SE) samples are run on the same material, average the results. If an individual result varies by more than \pm 4, based on the average result, additional tests shall be run.

Calculations

Calculate the SE to the nearest 0.1 using the following formula:

$$SE = \frac{\text{Sand Reading}}{\text{Clay Reading}} \times 100$$

Example

$$SE = \frac{3.3}{8.0} \times 100 = 41.25 \text{ or } 41.3 \quad \text{Report 42}$$

Given:

Sand Reading = 3.3

Clay Reading = 8.0

Note 7: This example reflects the use of equipment made with English units. At this time, equipment made with metric units is not available.

Report the SE as the next higher whole number. In the example above, the 41.3 would be reported as 42. An SE of 41.0 would be reported as 41.

When averaging two or more samples, raise each calculated SE value to the next higher whole number (reported value) before averaging.

Example:

calculated value 1 = 41.3

calculated value 2 = 42.8

These values are reported as 42 and 43, respectively.

Average the two reported values:

$$\text{Average SE} = \frac{42 + 43}{2} = 42.5 \quad \text{Report 43}$$

If the average value is not a whole number, raise it to the next higher whole number.

Report

- On forms approved by the agency
- Sample ID
- Results to the next higher whole number
- Sedimentation time if over 20 minutes

AGGREGATE

WAQTC

FOP AASHTO T 176 (22)

PERFORMANCE EXAM CHECKLIST**PLASTIC FINES IN GRADED AGGREGATES AND SOILS BY THE USE OF THE SAND EQUIVALENT TEST
FOP FOR AASHTO T 176**

Participant Name _____ Exam Date _____

Record the symbols "P" for passing or "F" for failing on each step of the checklist.

Procedure Element	Trial 1	Trial 2
Sample Preparation		
1. Sample passed through 4.75 mm (No. 4) sieve?	_____	_____
2. Material in clods broken up and re-screened?	_____	_____
3. Split or quarter 1,000 to 1,500 g of material passing the 4.75 mm (No. 4) sieve? NOTE: If necessary, the material may be dampened before splitting to avoid segregation or loss of fines.	_____	_____
4. No fines lost?	_____	_____
5. Working solution dated?	_____	_____
6. Temperature of working solution $22 \pm 3^{\circ}\text{C}$ ($72 \pm 5^{\circ}\text{F}$)?	_____	_____
7. Working calcium chloride solution 915 ± 25 mm (36 ± 1 in) above the work surface?	_____	_____
8. 101.6 ± 2.5 mm (4 ± 0.1 in) working calcium chloride solution siphoned into cylinder?	_____	_____
9. Material checked for moisture condition by tightly squeezing small portion in palm of hand and forming a cast?	_____	_____
10. Sample at proper water content?		
a. If too dry (cast crumbles easily) water added, re-mixed, covered, and allowed to stand for at least 15 minutes?	_____	_____
b. If too wet (shows free water) sample drained, air dried and mixed frequently?	_____	_____
11. Sample placed on splitting cloth and mixed by alternately lifting each corner of the cloth and pulling it over the sample toward diagonally opposite corner, causing material to be rolled?	_____	_____
12. Is material thoroughly mixed?	_____	_____
13. When material appears to be homogeneous, mixing finished with sample in a pile near center of cloth?	_____	_____
14. Fill the 85 mL (3 oz) tin by pushing through base of pile with other hand on opposite side of pile?	_____	_____
15. Material fills tin to overflowing?	_____	_____
16. Material compacted into tin with palm of hand?	_____	_____

OVER

Procedure Element

Trial 1 Trial 2

- 17. Tin struck off level using spatula or straightedge? _____
- 18. Prepared sample funneled into cylinder with no loss of fines? _____
- 19. Bottom of cylinder tapped sharply on heel of hand several times to release air bubbles? _____
- 20. Wetted sample allowed to stand undisturbed for 10 min. ±1 min.? _____
- 21. Cylinder stoppered and material loosened from bottom by shaking? _____
- 22. Stoppered cylinder shaken:
 - a. Mechanical: for 45 ±1 seconds? _____
 - b. Manual: for 100 strokes? _____
 - c. Hand: 90 cycles in approximately 30 seconds? _____
- 23. Following shaking, cylinder set vertical on work surface and stopper removed? _____
- 24. Irrigator tube inserted in cylinder and material rinsed from cylinder walls as irrigator is lowered? _____
- 25. Irrigator tube forced through material to bottom of cylinder by gentle stabbing and twisting action? _____
- 26. Stabbing and twisting motion applied until cylinder filled to 381 mm (15 in.) mark? _____
- 27. Liquid raised and maintained at 381 mm (15 in.) mark while irrigator is being withdrawn? _____
- 28. Liquid at the 381 mm (15 in.) mark? _____
- 29. Contents let stand 20 minutes ±15 seconds? _____
- 30. Timing started immediately after withdrawal of irrigator? _____
- 31. No vibration or disturbance of the sample? _____
- 32. Readings taken at 20 minutes or up to 30 minutes, when a definite line appears? _____
- 33. Clay level correctly read, rounded, and recorded? _____
- 34. Weighted foot assembly lowered into cylinder without hitting mouth of cylinder? _____
- 35. Sand level correctly read, rounded, and recorded? _____
- 36. Calculations performed correctly? _____

Comments: First attempt: Pass___Fail_____ Second attempt:Pass___Fail_____

Examiner Signature _____ **WAQTC #:** _____

WSDOT Errata to FOP for AASHTO T 180

Moisture-Density Relations of Soils

Using a 4.54 KG (10 LB) Rammer and a 457 MM (18 IN.) Drop

WAQTC FOP for AASHTO T 180 has been adopted by WSDOT with the following changes:

Scope

Replace with below:

This procedure covers the determination of the moisture-density relations of soils and soil-aggregate mixtures in accordance with two similar test methods:

AASHTO T 99-22: Methods A, B, C, and D

AASHTO T 180-22: Methods A, B, C, and D

This test method applies to soil mixtures having **30** percent or less retained on the 4.75 mm (No. 4) sieve for methods A or B, or, 30 percent or less retained on the 19 mm ($\frac{3}{4}$ in) with methods C or D. The retained material is defined as oversize (coarse) material. If no minimum percentage is specified, 5 percent will be used. Samples that contain oversize (coarse) material that meet percent retained criteria should be corrected by using *Annex A, Correction of Maximum Dry Density and Optimum Moisture for Oversized Particles*. Samples of soil or soil-aggregate mixture are prepared at several moisture contents and compacted into molds of specified size, using manual or mechanical rammers that deliver a specified quantity of compactive energy. The moist masses of the compacted samples are multiplied by the appropriate factor to determine wet density values. Moisture contents of the compacted samples are determined and used to obtain the dry density values of the same samples. Maximum dry density and optimum moisture content for the soil or soil-aggregate mixture is determined by plotting the relationship between dry density and moisture content.

**MOISTURE-DENSITY RELATIONS OF SOILS:
USING A 2.5 KG (5.5 LB) RAMMER AND A 305 MM (12 IN.) DROP****FOP FOR AASHTO T 99
USING A 4.54 KG (10 LB) RAMMER AND A 457 MM (18 IN.) DROP
FOP FOR AASHTO T 180****Scope**

This procedure covers the determination of the moisture-density relations of soils and soil-aggregate mixtures in accordance with two similar test methods:

- AASHTO T 99-22: Methods A, B, C, and D
- AASHTO T 180-22: Methods A, B, C, and D

This test method applies to soil mixtures having 40 percent or less retained on the 4.75 mm (No. 4) sieve for methods A or B, or 30 percent or less retained on the 19 mm ($\frac{3}{4}$ in.) sieve with methods C or D. The retained material is defined as oversize (coarse) material. If no minimum percentage is specified, 5 percent will be used. Samples that contain oversize (coarse) material that meet percent retained criteria should be corrected by using *Annex A, Correction of Maximum Dry Density and Optimum Moisture for Oversized Particles*. Samples of soil or soil-aggregate mixture are prepared at several moisture contents and compacted into molds of specified size, using manual or mechanical rammers that deliver a specified quantity of compactive energy. The moist masses of the compacted samples are multiplied by the appropriate factor to determine wet density values. Moisture contents of the compacted samples are determined and used to obtain the dry density values of the same samples. Maximum dry density and optimum moisture content for the soil or soil-aggregate mixture is determined by plotting the relationship between dry density and moisture content.

Apparatus

- Mold – Cylindrical mold made of metal with the dimensions shown in Table 1 or Table 2. If permitted by the agency, the mold may be of the “split” type, consisting of two half-round sections, which can be securely locked in place to form a cylinder. Determine the mold volume according to *Annex B, Standardization of the Mold*.
- Mold assembly – Mold, base plate, and a detachable collar.
- Rammer – Manually or mechanically operated rammers as detailed in Table 1 or Table 2. A manually operated rammer shall be equipped with a guide sleeve to control the path and height of drop. The guide sleeve shall have at least four vent holes no smaller than 9.5 mm ($\frac{3}{8}$ in.) in diameter, spaced approximately 90 degrees apart and approximately 19 mm ($\frac{3}{4}$ in.) from each end. A mechanically operated rammer will uniformly distribute blows over the sample and will be calibrated with several soil types, and be adjusted, if necessary, to give the same moisture-density results as with the manually operated rammer. For additional information concerning calibration, see AASHTO T 99 and T 180.

- Sample extruder – A jack, lever frame, or other device for extruding compacted specimens from the mold quickly and with little disturbance.
- Balance(s) or scale(s) of the capacity and sensitivity required for the procedure used by the agency.
 - A balance or scale with a capacity of 11.5 kg (25 lb) and a sensitivity of 1 g for obtaining the sample, meeting the requirements of AASHTO M 231, Class G 5.
 - A balance or scale with a capacity of 2 kg and a sensitivity of 0.1 g is used for moisture content determinations done under both procedures, meeting the requirements of AASHTO M 231, Class G 2.
- Drying apparatus – A thermostatically controlled drying oven, capable of maintaining a temperature of $110 \pm 5^{\circ}\text{C}$ ($230 \pm 9^{\circ}\text{F}$) for drying moisture content samples in accordance with the FOP for AASHTO T 255/T 265.
- Straightedge – A steel straightedge at least 250 mm (10 in.) long, with one beveled edge and at least one surface plane within 0.1 percent of its length, used for final trimming.
- Sieve(s) – 4.75 mm (No. 4) and/or 19.0 mm (3/4 in.), meeting the requirements of FOP for AASHTO T 27/T 11.
- Mixing tools – Miscellaneous tools such as a mixing pan, spoon, trowel, spatula, etc., or a suitable mechanical device, for mixing the sample with water.
- Containers with close-fitting lids to prevent gain or loss of moisture in the sample.

Table 1
Comparison of Apparatus, Sample, and Procedure – Metric

	T 99	T 180
Mold Volume, m ³	Methods A, C: 0.000943 ±0.000014	Methods A, C: 0.000943 ±0.000014
	Methods B, D: 0.002124 ±0.000025	Methods B, D: 0.002124 ±0.000025
Mold Diameter, mm	Methods A, C: 101.60 ±0.40	Methods A, C: 101.60 ±0.4
	Methods B, D: 152.40 ±0.70	Methods B, D: 152.40 ±0.70
Mold Height, mm	116.40 ±0.50	116.40 ±0.50
Detachable Collar Height, mm	50.80 ±0.64	50.80 ±0.64
Rammer Diameter, mm	50.80 ±0.25	50.80 ±0.25
Rammer Mass, kg	2.495 ±0.009	4.536 ±0.009
Rammer Drop, mm	305 ±2	457 ±2
Layers	3	5
Blows per Layer	Methods A, C: 25	Methods A, C: 25
	Methods B, D: 56	Methods B, D: 56
Material Size, mm	Methods A, B: 4.75 minus	Methods A, B: 4.75 minus
	Methods C, D: 19.0 minus	Methods C, D: 19.0 minus
Test Sample Size, kg	Method A: 3 Method C: 5 (1)	Method B: 7 Method D: 11(1)
Energy, kN-m/m ³	592	2,693

(1) This may not be a large enough sample depending on your nominal maximum size for moisture content samples.

Table 2
Comparison of Apparatus, Sample, and Procedure – English

	T 99	T 180
Mold Volume, ft ³	Methods A, C: 0.0333 ±0.0005	Methods A, C: 0.0333 ±0.0005
	Methods B, D: 0.07500 ±0.0009	Methods B, D: 0.07500 ±0.0009
Mold Diameter, in.	Methods A, C: 4.000 ±0.016	Methods A, C: 4.000 ±0.016
	Methods B, D: 6.000 ±0.026	Methods B, D: 6.000 ±0.026
Mold Height, in.	4.584 ±0.018	4.584 ±0.018
Detachable Collar Height, in.	2.000 ±0.025	2.000 ±0.025
Rammer Diameter, in.	2.000 ±0.025	2.000 ±0.025
Rammer Mass, lb	5.5 ±0.02	10 ±0.02
Rammer Drop, in.	12 ±0.06	18 ±0.06
Layers	3	5
Blows per Layer	Methods A, C: 25	Methods A, C: 25
	Methods B, D: 56	Methods B, D: 56
Material Size, in.	Methods A, B: No. 4 minus	Methods A, B: No.4 minus
	Methods C, D: 3/4 minus	Methods C, D: 3/4 minus
Test Sample Size, lb	Method A: 7 Method C: 12 ₍₁₎	Method B: 16 Method D: 25 ₍₁₎
Energy, lb-ft/ft ³	12,375	56,250

(1) This may not be a large enough sample depending on your nominal maximum size for moisture content samples.

Sample

If the sample is damp, dry it until it becomes friable under a trowel. Drying may be in air or by use of a drying apparatus maintained at a temperature not exceeding 60°C (140°F). Thoroughly break up aggregations in a manner that avoids reducing the natural size of individual particles.

Obtain a representative test sample of the mass required by the agency by passing the material through the sieve required by the agency. See Table 1 or Table 2 for test sample mass and material size requirements.

In instances where the material is prone to degradation, i.e., granular material, a compaction sample with differing moisture contents should be prepared for each point.

If the sample is plastic (clay types), it should stand for a minimum of 12 hours after the addition of water to allow the moisture to be absorbed. In this case, several samples at different moisture contents should be prepared, put in sealed containers, and tested the next day.

Note 1: Both T 99 and T 180 have four methods (A, B, C, D) that require different masses and employ different sieves.

Procedure

During compaction, rest the mold firmly on a dense, uniform, rigid, and stable foundation, or base. This base shall remain stationary during the compaction process.

1. Determine the mass of the clean, dry mold. Include the base plate but exclude the extension collar. Record the mass to the nearest 1 g (0.005 lb).
2. Thoroughly mix the selected representative sample with sufficient water to dampen it to approximately 4 to 8 percentage points below optimum moisture content. For many materials, this condition can be identified by forming a cast by hand.
 - a. Prepare individual samples of plastic or degradable material, increasing moisture contents 1 to 2 percent for each point.
 - b. Allow samples of plastic soil to stand for 12 hrs.
3. Form a specimen by compacting the prepared soil in the mold assembly in approximately equal layers. For each layer:
 - a. Spread the loose material uniformly in the mold.

Note 2: It is recommended to cover the remaining material with a non-absorbent sheet or damp cloth to minimize loss of moisture.

- b. Lightly tamp the loose material with the manual rammer or other similar device, this establishes a firm surface.
- c. Compact each layer with uniformly distributed blows from the rammer. See Table 1 for mold size, number of layers, number of blows, and rammer specification for the various test methods. Use the method specified by the agency.
- d. Trim down material that has not been compacted and remains adjacent to the walls of the mold and extends above the compacted surface.

4. Remove the extension collar. Avoid shearing off the sample below the top of the mold. The material compacted in the mold should not be over 6 mm ($\frac{1}{4}$ in.) above the top of the mold once the collar has been removed.
5. Trim the compacted soil even with the top of the mold with the beveled side of the straightedge.
6. Clean soil from exterior of the mold and base plate.
7. Determine and record the mass of the mold, base plate, and wet soil to the nearest 1 g (0.005 lb).
8. Determine and record the wet mass (M_w) of the sample by subtracting the mass in Step 1 from the mass in Step 7.
9. Calculate the wet density (ρ_w), in kg/m^3 (lb/ft^3), by dividing the wet mass by the measured volume (V_m).
10. Extrude the material from the mold. For soils and soil-aggregate mixtures, slice vertically through the center and remove one of the cut faces for a representative moisture content sample. For granular materials, a vertical face will not exist. Take a representative sample ensuring that all layers are represented. This sample must meet the sample size requirements of the test method used to determine moisture content.

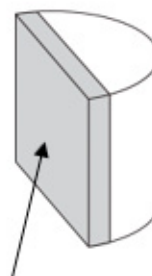

Extruded material

Representative moisture
content sample

Note 3: When developing a curve for free-draining soils such as uniform sands and gravels, where seepage occurs at the bottom of the mold and base plate, taking a representative moisture content from the mixing bowl may be preferred in order to determine the amount of moisture available for compaction.

11. Determine and record the moisture content (w) of the sample in accordance with the FOP for AASHTO T 255 / T 265.
12. If the material is degradable or plastic, return to Step 3 using a prepared individual sample. If not, continue with Steps 13 through 15.
13. Thoroughly break up the remaining portion of the molded specimen until it will again pass through the sieve, as judged by eye, and add to the remaining portion of the sample being tested.
14. Add sufficient water to increase the moisture content of the remaining soil by 1 to 2 percentage points and repeat steps 3 through 11.

15. Continue determinations until there is either a decrease or no change in the wet mass. There will be a minimum of three points on the dry side of the curve and two points on the wet side. For non-cohesive, drainable soils, one point on the wet side is sufficient.

Calculations

Wet Density

$$\rho_w = \frac{M_w}{V_m}$$

Where:

- ρ_w = wet density, kg/m³ (lb/ft³)
 M_w = wet mass
 V_m = volume of the mold, Annex B

Dry Density

$$\rho_d = \left(\frac{\rho_w}{w + 100} \right) \times 100 \quad \text{or} \quad \rho_d = \frac{\rho_w}{\left(\frac{w}{100} \right) + 1}$$

Where:

- ρ_d = dry density, kg/m³ (lb/ft³)
 w = moisture content, as a percentage

Example for 4-inch mold, Methods A or C

- Wet mass, M_w = 1.928 kg (4.25 lb)
 Moisture content, w = 11.3%
 Measured volume of the mold, V_m = 0.000946 m³ (0.0334 ft³)

Wet Density

$$\rho_w = \frac{1.928 \text{ kg}}{0.000946 \text{ m}^3} = 2038 \text{ kg/m}^3 \quad \rho_w = \frac{4.25 \text{ lb}}{0.0334 \text{ ft}^3} = 127.2 \text{ lb/ft}^3$$

Dry Density

$$\rho_d = \left(\frac{2038 \text{ kg/m}^3}{11.3 + 100} \right) \times 100 = 1831 \text{ kg/m}^3 \quad \rho_d = \left(\frac{127.2 \text{ lb/ft}^3}{11.3 + 100} \right) \times 100 = 114.3 \text{ lb/ft}^3$$

Or

$$\rho_d = \left(\frac{2038 \text{ kg/m}^3}{\frac{11.3}{100} + 1} \right) = 1831 \text{ kg/m}^3 \quad \rho_d = \left(\frac{127.2 \text{ lb/ft}^3}{\frac{11.3}{100} + 1} \right) = 114.3 \text{ lb/ft}^3$$

Moisture-Density Curve Development

When dry density is plotted on the vertical axis versus moisture content on the horizontal axis and the points are connected with a smooth line, a moisture-density curve is developed. The coordinates of the peak of the curve are the maximum dry density, or just “maximum density,” and the “optimum moisture content” of the soil.

Example

Given the following dry density and corresponding moisture content values develop a moisture-density relations curve and determine maximum dry density and optimum moisture content.

Dry Density		Moisture Content, %
kg/m ³	lb/ft ³	
1831	114.3	11.3
1853	115.7	12.1
1873	116.9	12.8
1869	116.7	13.6
1857	115.9	14.2

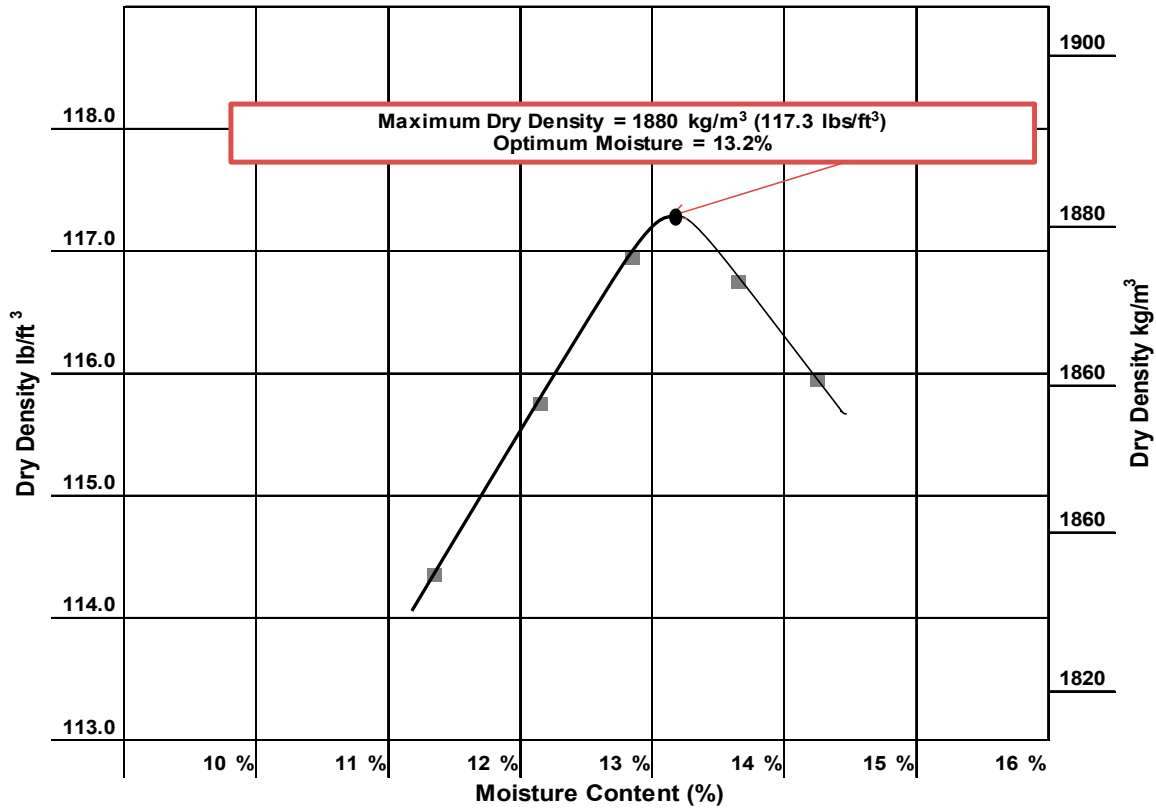

In this case, the curve has its peak at:

Maximum dry density = 1880 kg/m³ (117.3 lb/ft³)

Optimum moisture content = 13.2%

Note that both values are approximate since they are based on sketching the curve to fit the points.

Report

- Results on forms approved by the agency
- Sample ID
- Maximum dry density to the nearest 1 kg/m³ (0.1 lb/ft³)
- Optimum moisture content to the nearest 0.1 percent

ANNEX A**CORRECTION OF MAXIMUM DRY DENSITY AND OPTIMUM MOISTURE FOR
OVERSIZED PARTICLES**

(Mandatory Information)

This section corrects the maximum dry density and moisture content of the material retained on the 4.75 mm (No. 4) sieve, Methods A and B; or the material retained on the 19 mm ($\frac{3}{4}$ in.) sieve, Methods C and D. The maximum dry density, corrected for oversized particles and total moisture content, are compared with the field-dry density and field moisture content.

This correction can be applied to the sample on which the maximum dry density is performed. A correction may not be practical for soils with only a small percentage of oversize material. The agency shall specify a minimum percentage below which the method is not needed. If not specified, this method applies when more than 5 percent by weight of oversize particles is present.

Bulk specific gravity (G_{sb}) of the oversized particles is required to determine the corrected maximum dry density. Use the bulk specific gravity as determined using the FOP for AASHTO T 85 in the calculations. For construction activities, an agency established value or specific gravity of 2.600 may be used.

This correction can also be applied to the sample obtained from the field while performing in-place density.

Procedure

1. Use the sample from this procedure or a sample obtained according to the FOP for AASHTO T 310.
2. Sieve the sample on the 4.75 mm (No. 4) sieve for Methods A and B or the 19 mm ($\frac{3}{4}$ in.) sieve, Methods C and D.
3. Determine the dry mass of the oversized and fine fractions (M_{DC} and M_{DF}) by one of the following:
 - a. Dry the fractions, fine and oversized, in air or by use of a drying apparatus that is maintained at a temperature not exceeding 60°C (140°F).
 - b. Calculate the dry masses using the moisture samples.

To determine the dry mass of the fractions using moisture samples.

1. Determine the moist mass of both fractions, fine (M_{Mf}) and oversized (M_{Mc}):
2. Obtain moisture samples from the fine and oversized material.
3. Determine the moisture content of the fine particles (MC_f) and oversized particles (MC_c) of the material by FOP for AASHTO T 255/T 265 or agency approved method.
4. Calculate the dry mass of the oversize and fine particles.

$$M_D = \frac{M_m}{1 + MC}$$

Where:

M_D = mass of dry material (fine or oversize particles)

M_m = mass of moist material (fine or oversize particles)

MC = moisture content of respective fine or oversized, expressed as a decimal

5. Calculate the percentage of the fine (P_f) and oversized (P_c) particles by dry weight of the total sample as follows: See Note 2.

$$P_f = \frac{100 \times M_{DF}}{M_{DF} + M_{DC}} \quad \frac{100 \times 15.4 \text{ lb}}{15.4 \text{ lbs} + 5.7 \text{ lb}} = 73\% \quad \frac{100 \times 6.985 \text{ kg}}{6.985 \text{ kg} + 2.585 \text{ kg}} = 73\%$$

And

$$P_c = \frac{100 \times M_{DC}}{M_{DF} + M_{DC}} \quad \frac{100 \times 5.7 \text{ lb}}{15.4 \text{ lbs} + 5.7 \text{ lb}} = 27\% \quad \frac{100 \times 2.585 \text{ kg}}{6.985 \text{ kg} + 2.585 \text{ kg}} = 27\%$$

Or for P_c :

$$P_c = 100 - P_f$$

Where:

P_f = percent of fine particles, of sieve used, by weight

P_c = percent of oversize particles, of sieve used, by weight

M_{DF} = mass of dry fine particles

M_{DC} = mass of dry oversize particles

Optimum Moisture Correction Equation

1. Calculate the corrected moisture content as follows:

$$MC_T = \frac{(MC_F \times P_f) + (MC_c \times P_c)}{100} = \frac{(13.2\% \times 73.0\%) + (2.1\% \times 27.0\%)}{100} = 10.2\%$$

MC_T = corrected moisture content of combined fines and oversized particles, expressed as a % moisture

MC_F = moisture content of fine particles, as a % moisture

MC_C = moisture content of oversized particles, as a % moisture

Note 1: Moisture content of oversize material can be assumed to be two (2) percent for most construction applications.

Note 2: In some field applications agencies will allow the percentages of oversize and fine materials to be determined with the materials in the wet state.

Density Correction Equation

2. Calculate the corrected dry density (ρ_d) of the total sample (combined fine and oversized particles) as follows:

$$\rho_d = \frac{100\%}{\left[\left(\frac{P_f}{\rho_f} \right) + \left(\frac{P_c}{k} \right) \right]}$$

Where:

ρ_d = corrected total dry density (combined fine and oversized particles)
kg/m³ (lb/ft³)

ρ_f = dry density of the fine particles kg/m³ (lb/ft³), determined in the lab

P_c = percent of dry oversize particles, of sieve used, by weight.

P_f = percent of dry fine particles, of sieve used, by weight.

k = Metric: 1,000 * Bulk Specific Gravity (G_{sb}) (oven dry basis)
of coarse particles (kg/m³).

k = English: 62.4 * Bulk Specific Gravity (G_{sb}) (oven dry basis)
of coarse particles (lb/ft³)

Note 3: If the specific gravity is known, then this value will be used in the calculation. For most construction activities the specific gravity for aggregate may be assumed to be 2.600.

EMBANKMENT AND BASE
IN-PLACE DENSITY

WAQTC

FOP AASHTO T 99 / T 180 (22)

Calculation

Example

- Metric:

Maximum laboratory dry density (ρ_p):	1880 kg/m ³
Percent coarse particles (P_c):	27%
Percent fine particles (P_f):	73%
Mass per volume coarse particles (k):	(2.697) (1000) = 2697 kg/m ³

$$\rho_d = \frac{100\%}{\left[\left(\frac{P_f}{\rho_f}\right) + \left(\frac{P_c}{k}\right)\right]}$$

$$\rho_d = \frac{100\%}{\left[\left(\frac{73\%}{1880 \text{ kg/m}^3}\right) + \left(\frac{27\%}{2697 \text{ kg/m}^3}\right)\right]}$$

$$\rho_d = \frac{100\%}{[0.03883 \text{ kg/m}^3 + 0.01001 \text{ kg/m}^3]}$$

$$\rho_d = 2047.5 \text{ kg/m}^3 \text{ report } 2048 \text{ kg/m}^3$$

EMBANKMENT AND BASE
IN-PLACE DENSITY

WAQTC

FOP AASHTO T 99 / T 180 (22)

English:

Maximum laboratory dry density (ρ_f): 117.3 lb/ft³

Percent coarse particles (P_c): 27%

Percent fine particles (P_f): 73%

Mass per volume of coarse particles (k): (2.697) (62.4) = 168.3 lb/ft³

$$\rho_d = \frac{100\%}{\left[\left(\frac{P_f}{\rho_f}\right) + \left(\frac{P_c}{k}\right)\right]}$$

$$\rho_d = \frac{100\%}{\left[\left(\frac{73\%}{117.3 \text{ lb/ft}^3}\right) + \left(\frac{27\%}{168.3 \text{ lb/ft}^3}\right)\right]}$$

$$\rho_d = \frac{100\%}{[0.6223 \text{ lb/ft}^3 + 0.1604 \text{ lb/ft}^3]}$$

$$\rho_d = \frac{100\%}{0.7827 \text{ lb/ft}^3}$$

$$\rho_d = 127.76 \text{ lb/ft}^3 \quad \text{Report } 127.8 \text{ lb/ft}^3$$

Report

- On forms approved by the agency
- Sample ID
- Corrected maximum dry density to the nearest 1 kg/m³ (0.1 lb/ft³)
- Corrected optimum moisture to the nearest 0.1 percent

ANNEX B**STANDARDIZATION OF THE MOLD**

(Mandatory Information)

Standardization is a critical step to ensure accurate test results when using this apparatus. Failure to perform the standardization procedure as described herein will produce inaccurate or unreliable test results.

Apparatus

- Mold and base plate
- Balance or scale – Accurate to within 45 g (0.1 lb) or 0.3 percent of the test load, whichever is greater, at any point within the range of use.
- Cover plate – A piece of plate glass, at least 6 mm (1/4 in.) thick and at least 25 mm (1 in.) larger than the diameter of the mold.
- Thermometers – Standardized liquid-in-glass, or electronic digital total immersion type, accurate to 0.5°C (1°F)

Procedure

1. Create a watertight seal between the mold and base plate.
2. Determine and record the mass of the dry sealed mold, base plate, and cover plate.
3. Fill the mold with water at a temperature between 16°C and 29°C (60°F and 85°F) and cover with the cover plate in such a way as to eliminate bubbles and excess water.
4. Wipe the outside of the mold, base plate, and cover plate dry, being careful not to lose any water from the mold.
5. Determine and record the mass of the filled mold, base plate, cover plate, and water.
6. Determine and record the mass of the water in the mold by subtracting the mass in Step 2 from the mass in Step 5.
7. Measure the temperature of the water and determine its density from Table B1, interpolating, as necessary.
8. Calculate the volume of the mold, V_m , by dividing the mass of the water in the mold by the density of the water at the measured temperature.

EMBANKMENT AND BASE
IN-PLACE DENSITY

WAQTC

FOP AASHTO T 99 / T 180 (22)

Calculations

$$V_m = \frac{M}{\rho_{water}}$$

Where:

V_m = volume of the mold

M = mass of water in the mold

ρ_{water} = density of water at the measured temperature

Example

Mass of water in mold = 0.94367 kg (2.0800 lb)

ρ_{water} at 23°C (73.4°F) = 997.54 kg/m³ (62.274 lb/ft³)

$$V_m = \frac{0.94367 \text{ kg}}{997.54 \text{ kg/m}^3} = 0.000946 \text{ m}^3 \quad V_m = \frac{2.0800 \text{ lb}}{62.274 \text{ lb/ft}^3} = 0.0334 \text{ ft}^3$$

Table B1
Unit Mass of Water
15°C to 30°C

°C	(°F)	kg/m ³	(lb/ft ³)	°C	(°F)	kg/m ³	(lb/ft ³)
15	(59.0)	999.10	(62.372)	23	(73.4)	997.54	(62.274)
15.6	(60.0)	999.01	(62.366)	23.9	(75.0)	997.32	(62.261)
16	(60.8)	998.94	(62.361)	24	(75.2)	997.29	(62.259)
17	(62.6)	998.77	(62.350)	25	(77.0)	997.03	(62.243)
18	(64.4)	998.60	(62.340)	26	(78.8)	996.77	(62.227)
18.3	(65.0)	998.54	(62.336)	26.7	(80.0)	996.59	(62.216)
19	(66.2)	998.40	(62.328)	27	(80.6)	996.50	(62.209)
20	(68.0)	998.20	(62.315)	28	(82.4)	996.23	(62.192)
21	(69.8)	997.99	(62.302)	29	(84.2)	995.95	(62.175)
21.1	(70.0)	997.97	(62.301)	29.4	(85.0)	995.83	(62.166)
22	(71.6)	997.77	(62.288)	30	(86.0)	995.65	(62.156)

EMBANKMENT AND BASE
IN-PLACE DENSITY

WAQTC

FOP AASHTO T 99 / T 180 (22)

Report

- Mold ID
- Date Standardized
- Temperature of the water
- Volume, V_m , of the mold to the nearest 0.000001 m^3 (0.0001 ft^3)

EMBANKMENT AND BASE
IN-PLACE DENSITY

WAQTC

FOP AASHTO T 99/T 180 (18)

PERFORMANCE EXAM CHECKLIST

MOISTURE-DENSITY RELATION OF SOILS FOP FOR AASHTO T 180

Participant Name _____ Exam Date _____

Record the symbols "P" for passing or "F" for failing on each step of the checklist.

Procedure Element	Trial 1	Trial 2
1. If damp, sample dried in air or drying apparatus, not exceeding 60°C (140°F)?	_____	_____
2. Sample broken up and an adequate amount sieved over the appropriate sieve (4.75 mm / No. 4 or 19.0 mm / 3/4 in.) to determine oversize (coarse particle) percentage?	_____	_____
3. Sample passing the sieve has appropriate mass?	_____	_____
4. If material is degradable:		
a. Multiple samples mixed with water varying moisture content by 1 to 2 percent, bracketing the optimum moisture content?	_____	_____
5. If soil is plastic (clay types):		
a. Multiple samples mixed with water varying moisture content by 1 to 2 percent, bracketing the optimum moisture content?	_____	_____
b. Samples placed in covered containers and allowed to stand for at least 12 hours?	_____	_____
6. Sample determined to be 4 to 8 percent below expected optimum moisture content?	_____	_____
7. Determine mass of clean, dry mold without collar to nearest 1 g (0.005 lb.)?	_____	_____
8. Mold placed on rigid and stable foundation?	_____	_____
9. Layer of soil (approximately one fifth compacted depth) placed in mold with collar attached, loose material lightly tamped?	_____	_____
10. Soil compacted with appropriate number of blows (25 or 56)?	_____	_____
11. Material adhering to the inside of the mold trimmed?	_____	_____
12. Layer of soil (approximately two fifths compacted depth) placed in mold with collar attached, loose material lightly tamped?	_____	_____
13. Soil compacted with appropriate number of blows (25 or 56)?	_____	_____
14. Material adhering to the inside of the mold trimmed?	_____	_____
15. Layer of soil (approximately three fifths compacted depth) placed in mold with collar attached, loose material lightly tamped?	_____	_____
16. Soil compacted with appropriate number of blows (25 or 56)?	_____	_____

OVER

EMBANKMENT AND BASE
IN-PLACE DENSITY

WAQTC

FOP AASHTO T 99/T 180 (18)

Procedure Element

Trial 1 Trial 2

17. Material adhering to the inside of the mold trimmed?	_____	_____
18. Layer of soil (approximately four fifths compacted depth) placed in mold with collar attached, loose material lightly tamped?	_____	_____
19. Soil compacted with appropriate number of blows (25 or 56)?	_____	_____
20. Material adhering to the inside of the mold trimmed?	_____	_____
21. Mold filled with soil such that compacted soil will be above the mold, loose material lightly tamped?	_____	_____
22. Soil compacted with appropriate number of blows (25 or 56)?	_____	_____
23. Collar removed without shearing off sample?	_____	_____
24. Approximately 6 mm (1/4 in.) of compacted material above the top of the mold (without the collar)?	_____	_____
25. Soil trimmed to top of mold with the beveled side of the straightedge?	_____	_____
26. Remove all soil from exterior surface of mold and base plate?	_____	_____
27. Mass of mold and contents determined to appropriate precision (1 g)?	_____	_____
28. Wet density calculated from the wet mass?	_____	_____
29. Soil removed from mold using a sample extruder if needed?	_____	_____
30. Soil sliced vertically through center (non-granular material)?	_____	_____
31. Moisture sample removed ensuring all layers are represented?	_____	_____
32. Moist mass determined immediately to 0.1 g?	_____	_____
33. Moisture sample mass of correct size?	_____	_____
34. Sample dried, and water content determined according to the FOP for T 255/T 265?	_____	_____
35. Remainder of material from mold broken up until it will pass through the sieve, as judged by eye, and added to remainder of original test sample?	_____	_____
36. Water added to increase moisture content of the remaining sample in approximately 1 to 2 percent increments?	_____	_____
37. Steps 2 through 20 repeated for each increment of water added?	_____	_____
38. Process continued until wet density either decreases or stabilizes?	_____	_____
39. Moisture content and dry density calculated for each sample?	_____	_____
40. Dry density plotted on vertical axis, moisture content plotted on horizontal axis, and points connected with a smooth curve?	_____	_____
41. Moisture content at peak of curve recorded as optimum water content and recorded to nearest 0.1 percent?	_____	_____
42. Dry density at optimum moisture content reported as maximum density to nearest 1 kg/m ³ (0.1 lb/ft ³)?	_____	_____

OVER

EMBANKMENT AND BASE
IN-PLACE DENSITY

WAQTC

FOP AASHTO T 99/T 180 (18)

Procedure Element

Trial 1 Trial 2

43. Corrected for coarse particles if applicable? _____

Comments: First attempt: Pass____Fail____ Second attempt: Pass____Fail____

Examiner Signature _____ WAQTC #: _____

EMBANKMENT AND BASE
IN-PLACE DENSITY

WAQTC

FOP AASHTO T 99/T 180 (18)

THEORETICAL MAXIMUM SPECIFIC GRAVITY (G_{mm}) AND DENSITY OF ASPHALT MIXTURES FOP FOR AASHTO T 209

Scope

This procedure covers the determination of the maximum specific gravity (G_{mm}) of uncompacted asphalt mixtures in accordance with AASHTO T 209-22. Two methods using different containers – bowl and pycnometer / volumetric flask– are covered.

Specimens prepared in the laboratory shall be cured according to agency standards.

Apparatus

- Balance or scale: 10,000 g capacity, readable to 0.1 g, meeting AASHTO M 231, Class G2
- Container: A glass, metal, or plastic bowl, pycnometer or volumetric flask between 2000 and 10,000 mL as required by the minimum sample size requirements in Table 1 sample and capable of withstanding full vacuum applied
- Pycnometer / volumetric flask cover: A glass plate or a metal or plastic cover with a vented opening
- Vacuum lid: A transparent lid with a suitable vacuum connection, with a vacuum opening to be covered with a fine wire mesh
- Vacuum pump or water aspirator: Capable of evacuating air from the container to a residual pressure of 3.4 kPa (25 mm Hg)
- Vacuum measurement device: Residual pressure manometer or vacuum gauge, capable of measuring residual pressure down to 3.4 kPa (25 mm Hg) or less and accurate to 0.1 kPa (1 mm Hg)
- Manometer or vacuum gauge: Capable of measuring the vacuum being applied at the source of the vacuum
- Water bath: A constant-temperature water bath (optional for Pycnometer or Volumetric Flask Method)
- Thermometers: Thermometric devices accurate to 0.25°C (0.5°F) and with a temperature range of at least 20 to 45°C (68 to 113°F).
- Bleeder valve to adjust vacuum
- Automatic vacuum control unit (optional)
- Timer
- Towel

Standardization

Use a container that has been standardized according to Annex A. The container shall be standardized periodically in conformance with procedures established by the agency.

Test Sample Preparation

1. Obtain samples in accordance with the FOP for AASHTO R 97 and reduce according to the FOP for AASHTO R 47.
2. Test sample size shall conform to the requirements of Table 1. Samples larger than the capacity of the container may be tested in two or more increments. Results will be combined by calculating the weighted average ($G_{mm (avg)}$). If the increments have a specific gravity difference greater than 0.013, the test must be re-run.
3. Plant-produced samples may be short-term conditioned according to AASHTO R 30 as specified by the agency.

Note 1: Short-term conditioning at the specified temperature is especially important when absorptive aggregates are used. This short-term conditioning will ensure the computation of realistic values for the amount of asphalt absorbed by the aggregate and void properties of the mix. Plant-produced asphalt mixtures should be evaluated to make sure short-term conditioning has taken place during production and delivery.

Table 1
Test Sample Size for G_{mm}

Nominal Maximum* Aggregate Size mm (in.)	Minimum Mass g
37.5 or greater (1½)	4000
19 to 25 (¾ to 1)	2500
12.5 or smaller (½)	1500

*Nominal maximum size: One sieve larger than the first sieve to retain more than 10 percent of the material using an agency specified set of sieves based on cumulative percent retained.

Procedure – General

Two procedures – bowl and pycnometer / volumetric flask – are covered. The first 11 steps are the same for both.

1. Separate the particles of the sample, taking care not to fracture the mineral particles, so that the particles of the fine aggregate portion are not larger than 6.3 mm (1/4 in.). If the mixture is not sufficiently soft to be separated manually, place it in a large flat pan and warm in an oven only until it is pliable enough for separation.
2. Cool the sample to room temperature.
3. Determine and record the mass of the dry container to the nearest 0.1 g.
4. Place the sample in the container.
5. Determine and record the mass of the dry container and sample to the nearest 0.1 g.

ASPHALT

WAQTC

FOP AASHTO T 209 (22)

6. Determine and record the mass of the sample by subtracting the mass determined in Step 3 from the mass determined in Step 5. Designate this mass as "A."
 7. Add sufficient water at approximately 25° C (77° F) to cover the sample by about 25 mm (1 in.).
- Note 1:* The release of entrapped air may be facilitated by the addition of a wetting agent. Check with the agency to see if this is permitted and, if it is, for a recommended agent.
8. Place the lid on the container and attach the vacuum line. To ensure a proper seal between the container and the lid, wet the O-ring or use a petroleum gel.
 9. Remove entrapped air by subjecting the sample to a partial vacuum of 3.7 ± 0.3 kPa (27.5 ± 2.5 mm Hg) residual pressure for 15 ± 1 minutes.
 10. Agitate the container and sample, either continuously by mechanical device or manually by vigorous shaking at 2-minute intervals. This agitation facilitates the removal of air.
 11. Release the vacuum. Increase the pressure to atmospheric pressure in 10 to 15 seconds if the vacuum release is not automated. Turn off the vacuum pump and remove the lid. When performing the pycnometer / volumetric flask method, complete steps 12B through 16B within 10 ± 1 minute.

Procedure – Bowl

- 12A. Fill the water bath to overflow level with water at $25 \pm 1^\circ\text{C}$ ($77 \pm 2^\circ\text{F}$) and allow the water to stabilize.
- 13A. Zero or tare the balance with the immersion apparatus attached, ensuring that the device is not touching the sides or the bottom of the water bath.
- 14A. Suspend and immerse the bowl and sample in water at $25 \pm 1^\circ\text{C}$ ($77 \pm 2^\circ\text{F}$) for 10 ± 1 minute. The holder shall be immersed sufficiently to cover both it and the bowl.
- 15A. Determine and record the submerged weight of the bowl and sample to the nearest 0.1 g. Designate as "C."

Procedure – Pycnometer or Volumetric Flask

- 12B. Immediately fill the pycnometer / volumetric flask with water without reintroducing air.
- 13B. Stabilize the temperature of the pycnometer / volumetric flask and sample so that the final temperature is within $25 \pm 1^\circ\text{C}$ ($77 \pm 2^\circ\text{F}$).
- 14B. Finish filling the pycnometer / volumetric flask with water that is $25 \pm 1^\circ\text{C}$ ($77 \pm 2^\circ\text{F}$), place the cover or a glass plate on the pycnometer / volumetric flask, and eliminate all air.

Note 2: When using a metal pycnometer and cover, place the cover on the pycnometer and push down slowly, forcing excess water out of the hole in the center of the cover. Use care when filling the pycnometer to avoid reintroducing air into the water.

- 15B. Towel dry the outside of the pycnometer / volumetric flask and cover.

- 16B. Determine and record the mass of the pycnometer / volumetric flask, cover, de-aired water, and sample to the nearest 0.1 g. within 10 ± 1 minute of completion of Step 11. Designate this mass as "E."

Procedure – Mixtures Containing Uncoated Porous Aggregate

If the pores of the aggregates are not thoroughly sealed by a bituminous film, they may become saturated with water during the vacuuming procedure, resulting in an error in maximum density. To determine if this has occurred, complete the general procedure and then:

1. Carefully drain water from sample through a towel held over the top of the container to prevent loss of material.
2. Spread sample in a flat shallow pan and place before an electric fan to remove surface moisture.
3. Determine the mass of the sample when the surface moisture appears to be gone.
4. Continue drying and determine the mass of the sample at 15-minute intervals until less than a 0.5 g loss is found between determinations.
5. Record the mass as the saturated surface dry mass to the nearest 0.1 g. Designate this mass as "ASSD."
6. Calculate, as indicated below, G_{mm} using "A" and "ASSD," and compare the two values.

Calculation

Calculate the G_{mm} to three decimal places as follows:

Bowl Procedure

$$G_{mm} = \frac{A}{A + B - C} \quad \text{or} \quad G_{mm} = \frac{A}{A_{SSD} + B - C}$$

(for mixes containing uncoated aggregate materials)

Where:

- A = mass of dry sample in air, g
 A_{SSD} = mass of saturated surface dry sample in air, g
 B = standardized submerged weight of the bowl, g (see Annex A)
 C = submerged weight of sample and bowl, g

ASPHALT

WAQTC

FOP AASHTO T 209 (22)

Example:

$$G_{mm} = \frac{1432.7 \text{ g}}{1432.7 \text{ g} + 286.3 \text{ g} - 1134.9 \text{ g}} = 2.453 \quad \text{or}$$

$$G_{mm} = \frac{1432.7 \text{ g}}{1434.2 \text{ g} + 286.3 \text{ g} - 1134.9 \text{ g}} = 2.447$$

Given:

$$A = 1432.7 \text{ g}$$

$$A_{SSD} = 1434.2 \text{ g}$$

$$B = 286.3 \text{ g}$$

$$C = 1134.9 \text{ g}$$

Pycnometer / Volumetric Flask Procedure

$$G_{mm} = \frac{A}{A + D - E} \quad \text{or} \quad G_{mm} = \frac{A}{A_{SSD} + D - E}$$

(for mixtures containing uncoated materials)

Where:

A = mass of dry sample in air, g

A_{SSD} = mass of saturated surface-dry sample in air, g

D = standardized mass of pycnometer / volumetric flask filled with water at 25°C (77°F), g, (See Annex A)

E = mass of pycnometer / volumetric flask filled with water and the test sample at test temperature, g

Example (two increments of a large sample):

$$G_{mm_1} = \frac{2200.3 \text{ g}}{2200.3 \text{ g} + 7502.5 \text{ g} - 8812.0 \text{ g}} = 2.470$$

$$G_{mm_2} = \frac{1960.2 \text{ g}}{1960.2 \text{ g} + 7525.5 \text{ g} - 8690.8 \text{ g}} = 2.466$$

Given:

Increment 1	Increment 2
A ₁ = 2200.3 g	A ₂ = 1960.2 g
D ₁ = 7502.5 g	D ₂ = 7525.5 g
E ₁ = 8812.0 g	E ₂ = 8690.8 g

$$\text{Variation} = 2.470 - 2.466 = 0.004, \text{ which is } < 0.013$$

Allowable variation is: 0.013. The values may be used.

Weighted average

For large samples tested a portion at a time, calculate the $G_{mm(avg)}$ by multiplying the dry mass of each increment by its G_{mm} , add the results together (Σ) and divide by the sum (Σ) of the dry masses.

$$G_{mm(avg)} = \frac{\Sigma(A_x \times G_{mm_x})}{\Sigma A_x}$$

or

$$G_{mm(avg)} = \frac{(A_1 \times G_{mm_1}) + (A_2 \times G_{mm_2})}{A_1 + A_2} \text{ etc.}$$

Where:

- A_x = mass of dry sample increment in air, g
 G_{mmx} = theoretical maximum specific gravity of the increment

ASPHALT

WAQTC

FOP AASHTO T 209 (22)

Example:

$$G_{mm(avg)} = \frac{(2200.3 \text{ g} \times 2.470) + (1960.2 \text{ g} \times 2.466)}{2200.3 \text{ g} + 1960.2 \text{ g}} = \frac{10,268.6}{4160.5 \text{ g}} = 2.468$$

Theoretical Maximum Density

To calculate the theoretical maximum density at 25°C (77°F) use one of the following formulas. The density of water at 25°C (77°F) is 997.1 kg/ m³ in Metric units or 62.245 lb/ft³ in English units.

$$\text{Theoretical maximum density kg/m}^3 = G_{mm} \times 997.1 \text{ kg/ m}^3$$

$$2.468 \times 997.1 \text{ kg/ m}^3 = 2461 \text{ kg/ m}^3$$

or

$$\text{Theoretical maximum density lb/ft}^3 = G_{mm} \times 62.245 \text{ lb/ft}^3$$

$$2.468 \times 62.245 \text{ lb/ft}^3 = 153.6 \text{ lb/ft}^3$$

Report

- On forms approved by the agency
- Sample ID
- G_{mm} to the nearest 0.001
- Theoretical maximum density to the nearest 1 kg/m³ (0.1 lb/ft³)

ASPHALT

WAQTC

FOP AASHTO T 209 (22)

ANNEX A – STANDARDIZATION OF BOWL AND PYCNOMETER OR VOLUMETRIC FLASK

(Mandatory Information)

Bowl – Standardization

1. Fill the water bath to overflow level with $25 \pm 1^{\circ}\text{C}$ ($77 \pm 2^{\circ}\text{F}$) water and allow the water to stabilize.
2. Zero or tare the balance with the immersion apparatus attached, ensuring that the device is not touching the sides or the bottom of the water bath.
3. Suspend and completely immerse the bowl for 10 ± 1 minute.
4. Determine and record the submerged weight of the bowl to the nearest 0.1 g.
5. Refill the water bath to overflow level.
6. Perform Steps 2 through 5 two more times for a total of three determinations.
7. If the range of the three determinations is less than or equal to 0.3 g., average the determinations. Designate as “B.”
8. If the range of the three determinations is greater than 0.3 g., take corrective action and perform the standardization procedure again.

Bowl – Check

1. Fill the water bath to overflow level $25 \pm 1^{\circ}\text{C}$ ($77 \pm 2^{\circ}\text{F}$) water and allow the water to stabilize.
2. Zero or tare the balance with the immersion apparatus attached, ensuring that the device is not touching the sides or the bottom of the water bath.
3. Suspend and completely immerse the bowl for 10 ± 1 minute.
4. Determine and record the submerged weight of the bowl to the nearest 0.1 g.
5. If this determination is within 0.3 g of the standardized value, use the standardized value for “B.”
6. If it is not within 0.3 g, take corrective action and perform the standardization procedure again.
7. For labs that check the bowl standardization frequently (such as daily), calculate the moving average and range of the last three mass determinations. Designate the average of the last three masses as “B.”
8. If the moving range exceeds 0.3 g at any time, take corrective action and perform the standardization procedure again.

Pycnometer or Volumetric Flask – Standardization

1. Fill the pycnometer / volumetric flask with water at approximately 25°C (77°F).
2. Place the metal or plastic cover, or a glass plate on the pycnometer / volumetric flask and eliminate all air. (See Note 2.)
3. Stabilize the pycnometer / volumetric flask at $25 \pm 1^\circ\text{C}$ ($77 \pm 2^\circ\text{F}$) for 10 ± 1 min.
4. Towel dry the outside of the pycnometer / volumetric flask and cover.
5. Determine and record the mass of the pycnometer / volumetric flask, water, and lid to the nearest 0.1 g.
6. Perform Steps 2 through 5 two more times for a total of three determinations.
7. If the range of the three determinations is less than or equal to 0.3 g, average the three determinations. Designate as “D.”
8. If the range of the determinations is greater than 0.3 g., take corrective action and perform the “Pycnometer or Volumetric Flask – Standardization” again.

Pycnometer or Volumetric Flask – Check

1. Fill the pycnometer / volumetric flask with water at approximately 25°C (77°F).
2. Place the metal or plastic cover or a glass plate on the pycnometer / volumetric flask and eliminate all air. (See Note 2.)
3. Stabilize the pycnometer / volumetric flask at $25 \pm 1^\circ\text{C}$ ($77 \pm 2^\circ\text{F}$) for 10 ± 1 min.
4. Towel dry the outside of the pycnometer / volumetric flask and cover.
5. Determine and record the mass of the pycnometer / volumetric flask, water, and lid.
6. If this determination is within 0.3 g of the standardized value, use the standardized value for “D.”
7. If it is not within 0.3 g, perform the standardization procedure again.

PERFORMANCE EXAM CHECKLIST

**THEORETICAL MAXIMUM SPECIFIC GRAVITY (G_{mm}) AND DENSITY OF ASPHALT MIXTURES
FOP FOR AASHTO T 209**

Participant Name _____ Exam Date _____

Record the symbols "P" for passing or "F" for failing on each step of the checklist.

Procedure Element	Trial 1	Trial 2
1. Sample reduced to correct size?	_____	_____
2. Particles carefully separated insuring that aggregate is not fractured?	_____	_____
3. After separation, fine aggregate particles not larger than 6.3 mm (1/4 in.)?	_____	_____
4. Sample at room temperature?	_____	_____
5. Standardized container (bowl or pycnometer / volumetric flask)?	_____	_____
6. Mass of container determined to 0.1 g?	_____	_____
7. Mass of sample and container determined to 0.1 g?	_____	_____
8. Mass of sample calculated and conforms to required size?	_____	_____
9. Water at approximately 25°C (77°F) added to cover sample?	_____	_____
10. O-ring wet or petroleum gel used?	_____	_____
11. Entrapped air removed using partial vacuum for 15 ±1 min?	_____	_____
12. Container and sample agitated continuously by mechanical device or manually by vigorous shaking at intervals of about 2 minutes?	_____	_____
13. Vacuum released to atmospheric pressure in 10 to 15 seconds if not auto controlled?	_____	_____
14. Vacuum pump turned off?	_____	_____
15. Bowl determination:		
a. Water bath filled to the overflow level?	_____	_____
b. Bowl and sample suspended in water at 25 ±1°C (77 ±2°F) for 10 ±1 minute?	_____	_____
c. Submerged weight of bowl and sample determined to 0.1 g?	_____	_____

OVER

ASPHALT

WAQTC

FOP AASHTO T 209 (22)

Procedure Element

Trial 1 Trial 2

16. Pycnometer / Volumetric Flask determination:

- a. Pycnometer / volumetric flask filled with water without reintroducing air into the sample?
- b. Contents stabilized at $25 \pm 1^\circ\text{C}$ ($77 \pm 2^\circ\text{F}$)
- c. Pycnometer / volumetric flask completely filled with water that is $25 \pm 1^\circ\text{C}$ ($77 \pm 2^\circ\text{F}$)?
- d. Mass of filled pycnometer / volumetric flask and cover determined to 0.1 g, 10 \pm 1 min. after removal of entrapped air completed?

_____	_____
_____	_____
_____	_____
_____	_____

17. G_{mm} calculated correctly and reported to 0.001?

18. Density calculated correctly and reported to 1 kg/m^3 (0.1 lb/ft^3)?

Comments: First attempt: Pass _____ Fail _____ Second attempt: Pass _____ Fail _____

Examiner Signature _____ WAQTC #: _____

WSDOT Errata to FOP for AASHTO T 255

Total Evaporable Moisture Content of Aggregate by Drying

WAQTC FOP for AASHTO T 255 has been adopted by WSDOT with the following changes:

Sample Preparation

TABLE 1 Sample Sizes for Moisture Content of Aggregate – *Shall conform to the following nominal maximum size definition and include the note below.*

*For Aggregate, the nominal maximum size sieve is the largest standard sieve opening listed in the applicable specification upon which more than 1-percent of the material by weight is permitted to be retained. For concrete aggregate, the nominal maximum size sieve is the smallest standard sieve opening through which the entire amount of aggregate is permitted to pass.

Note: For an aggregate specification having a generally unrestrictive gradation (i.e., wide range of permissible upper sizes), where the source consistently fully passes a screen substantially smaller than the maximum specified size, the nominal maximum size, for the purpose of defining sampling and test specimen size requirements may be adjusted to the screen, found by experience to retain no more than 5 percent of the materials.

TOTAL EVAPORABLE MOISTURE CONTENT OF AGGREGATE BY DRYING FOP FOR AASHTO T 255

Scope

This procedure covers the determination of moisture content of aggregate in accordance with AASHTO T 255-22. It may also be used for other construction materials.

Overview

Moisture content is determined by comparing the wet mass of a sample and the mass of the sample after drying to constant mass. The term constant mass is used to define when a sample is dry.

Constant mass – the state at which a mass does not change more than a given percent, after additional drying for a defined time interval, at a required temperature.

Apparatus

- Balance or scale: Capacity sufficient for the principal sample mass, accurate to 0.1 percent of sample mass or readable to 0.1 g, meeting the requirements of AASHTO M 231.
- Containers: clean, dry, and capable of being sealed
- Suitable drying containers
- Microwave safe container with ventilated lids
- Heat source: thermostatically controlled, capable of maintaining $110 \pm 5^{\circ}\text{C}$ ($230 \pm 9^{\circ}\text{F}$).
 - Forced draft oven (preferred)
 - Ventilated oven
 - Convection oven
- Heat source, uncontrolled, for use when allowed by the agency, will not alter the material being dried, and close control of the temperature is not required.
 - Infrared heater, hot plate, fry pan, or any other device/method allowed by the agency
 - Microwave oven (900 watts minimum)
- Hot pads or gloves
- Utensils such as spoons

Sample Preparation

Obtain a representative sample according to the FOP for AASHTO R 90 in its existing condition. If necessary, reduce to moisture content sample size according to the FOP for AASHTO R 76.

The moisture content sample size is based on Table 1 or other information that may be specified by the agency.

TABLE 1
Sample Sizes for Moisture Content of Aggregate

Nominal Maximum Size* mm (in.)	Minimum Sample Mass g (lb)
150 (6)	50,000 (110)
100 (4)	25,000 (55)
90 (3 1/2)	16,000 (35)
75 (3)	13,000 (29)
63 (2 1/2)	10,000 (22)
50 (2)	8000 (18)
37.5 (1 1/2)	6000 (13)
25.0 (1)	4000 (9)
19.0 (3/4)	3000 (7)
12.5 (1/2)	2000 (4)
9.5 (3/8)	1500 (3.3)
4.75 (No. 4)	500 (1.1)

* One sieve larger than the first sieve to retain more than 10 percent of the material using an agency specified set of sieves based on cumulative percent retained. Where large gaps in specification sieves exist, intermediate sieve(s) may be inserted to determine nominal maximum size.

Immediately seal or cover moisture content samples to prevent any change in moisture content or follow the steps in “Procedure.”

Procedure

Determine all masses to the nearest 0.1 percent of the sample mass or to the nearest 0.1 g.

When determining the mass of hot samples or containers or both, place and tare a buffer between the sample container and the balance. This will eliminate damage to or interference with the operation of the balance or scale.

1. Determine and record the mass of the container (and lid for microwave drying).
2. Place the wet sample in the container.
3. Determine and record the total mass of the container and wet sample.

- a. For oven(s), hot plates, infrared heaters, etc.: Spread the sample in the container.
- b. For microwave oven: Heap sample in the container; cover with ventilated lid.
4. Determine and record the wet mass of the sample (M_w) by subtracting the container mass determined in Step 1 from the mass of the container and sample determined in Step 3.
5. Place the sample in one of the following drying apparatuses:
 - a. Controlled heat source (oven): at $110 \pm 5^\circ\text{C}$ ($230 \pm 9^\circ\text{F}$).
 - b. Uncontrolled heat source (Hot plate, infrared heater, or other heat sources as allowed by the agency): Stir frequently to avoid localized overheating.
6. Dry until sample appears moisture free.
7. Determine mass of sample and container.
8. Determine and record the mass of the sample by subtracting the container mass determined in Step 1 from the mass of the container and sample determined in Step 7.
9. Return sample and container to the heat source for additional drying.
 - a. Controlled (oven): 30 minutes
 - b. Uncontrolled (Hot plate, infrared heater, or other heat sources as allowed by the agency): 10 minutes
 - c. Uncontrolled (Microwave oven): 2 minutes
- Caution:** Some minerals in the sample may cause the aggregate to overheat, crack and explode, altering the aggregate gradation.
10. Determine mass of sample and container.
11. Determine and record the mass of the sample by subtracting the container mass determined in Step 1 from the mass of the container and sample determined in Step 10.
12. Determine percent change by subtracting the new mass determination (M_n) from the previous mass determination (M_p) divide by the previous mass determination (M_p) multiply by 100.
13. Continue drying, performing steps 9 through 12, until there is less than a 0.10 percent change after additional drying time.
14. Constant mass has been achieved; sample is defined as dry.
15. Allow the sample to cool. Determine and record the total mass of the container and dry sample.
16. Determine and record the dry mass of the sample (M_D) by subtracting the mass of the container determined in Step 1 from the mass of the container and sample determined in Step 15.
17. Determine and record percent moisture (w) by subtracting the final dry mass determination (M_D) from the initial wet mass determination (M_w) divide by the final dry mass determination (M_D) multiply by 100.

TABLE 2
Methods of Drying

Heat Source	Specific Instructions	Drying intervals to achieve constant mass (minutes)
Controlled: Forced Draft Oven (preferred), Ventilated Oven, or Convection Oven	110 ±5°C (230 ±9°F)	30
Uncontrolled:		
Hot plate, Infrared heater, or any other device/method allowed by the agency	Stir frequently	10
Microwave	Heap sample and cover with ventilated lid	2

Calculation

Constant Mass:

Calculate constant mass using the following formula:

$$\% \text{ Change} = \frac{M_p - M_n}{M_p} \times 100$$

where:

M_p = previous mass measurement

M_n = new mass measurement

Example:

Mass of container: 1232.1 g

Mass of container after first drying cycle: 2637.2 g

Mass, M_p , of possibly dry sample: 2637.2 g - 1232.1 g = 1405.1 g

Mass of container and sample after second drying cycle: 2634.1 g

Mass, M_n , of sample: 2634.1 g - 1232.1 g = 1402.0 g

$$\% \text{ Change} = \frac{1405.1 \text{ g} - 1402.0 \text{ g}}{1405.1 \text{ g}} \times 100 = 0.22\%$$

0.22 percent is not less than 0.10 percent, so continue drying

AGGREGATE

WAQTC

FOP AASHTO T 255 (22)

Mass of container and sample after third drying cycle: 2633.0 g

Mass, M_n , of sample: 2633.0 g - 1232.1 g = 1400.9 g

$$\% \text{ Change} = \frac{1402.0 \text{ g} - 1400.9 \text{ g}}{1402.0 \text{ g}} \times 100 = 0.08\%$$

0.08 percent is less than 0.10 percent, so constant mass has been reached

Moisture Content:

Calculate the moisture content, w , as a percent, using the following formula:

$$w = \frac{M_W - M_D}{M_D} \times 100$$

where:

w = moisture content, percent

M_W = wet mass

M_D = dry mass

Example:

Mass of container: 1232.1 g

Mass of container and wet sample: 2764.7 g

Mass, M_W , of wet sample: 2764.7 g - 1232.1 g = 1532.6 g

Mass of container and dry sample (COOLED): 2633.5 g

Mass, M_D , of dry sample: 2633.5 g - 1232.1 g = 1401.4 g

$$w = \frac{1532.6 \text{ g} - 1401.4 \text{ g}}{1401.4 \text{ g}} \times 100 = \frac{131.7 \text{ g}}{1401.4 \text{ g}} = 9.40\% \text{ report } 9.4\%$$

Report

- On forms approved by the agency
- Sample ID
- M_W , wet mass
- M_D , dry mass
- Moisture content to the nearest 0.1 percent

AGGREGATE

WAQTC

FOP AASHTO T 255 (22)

PERFORMANCE EXAM CHECKLIST
TOTAL MOISTURE CONTENT OF AGGREGATE BY DRYING
FOP FOR AASHTO T 255

Participant Name _____ Exam Date _____

Record the symbols "P" for passing or "F" for failing on each step of the checklist.

Procedure Element	Trial 1	Trial 2
1. Representative sample of appropriate mass obtained?	_____	_____
2. Mass of container determined to 0.1 percent or 0.1 g?	_____	_____
3. Sample placed in container and wet mass determined to 0.1 percent or 0.1 g?	_____	_____
4. Test sample mass conforms to the required mass?	_____	_____
5. Loss of moisture avoided prior to mass determination?	_____	_____
6. Sample dried by a suitable heat source?	_____	_____
7. If aggregate heated by means other than a controlled oven, is sample stirred to avoid localized overheating?	_____	_____
8. If heated in a microwave, heaped and covered with a ventilated lid	_____	_____
9. Is aggregate heated for the additional, specified time?	_____	_____
a. Forced draft, ventilated, convection ovens – 30 minutes		
b. Microwave – 2 minutes		
c. Other – 10 minutes		
10. Mass determined and compared to previous mass – showing less than 0.10 percent loss?	_____	_____
11. Sample cooled before dry mass determination to 0.1 percent or 0.1 g?	_____	_____
12. Calculations performed properly, and results reported to the nearest 0.1 percent?	_____	_____

Comments: First attempt: Pass____Fail____ Second attempt: Pass____Fail____

Examiner Signature _____ WAQTC #: _____

AGGREGATE

WAQTC

FOP AASHTO T 255 (18)

WSDOT Errata to FOP for AASHTO T 265

Laboratory Determination of Moisture Content of Soils

WAQTC FOP for AASHTO T 265 has been adopted by WSDOT with the following changes:

Sample Preparation

TABLE 1 Sample Sizes for Moisture Content of Aggregate – *Shall conform to the following nominal maximum size definition and include the note below.*

*For Aggregate, the nominal maximum size sieve is the largest standard sieve opening listed in the applicable specification upon which more than 1-percent of the material by weight is permitted to be retained. For concrete aggregate, the nominal maximum size sieve is the smallest standard sieve opening through which the entire amount of aggregate is permitted to pass.

Note: For an aggregate specification having a generally unrestrictive gradation (i.e., wide range of permissible upper sizes), where the source consistently fully passes a screen substantially smaller than the maximum specified size, the nominal maximum size, for the purpose of defining sampling and test specimen size requirements may be adjusted to the screen, found by experience to retain no more than 5 percent of the materials.

**TOTAL EVAPORABLE MOISTURE CONTENT OF AGGREGATE BY DRYING
FOP FOR AASHTO T 255
LABORATORY DETERMINATION OF MOISTURE CONTENT OF SOILS
FOP FOR AASHTO T 265****Scope**

This procedure covers the determination of moisture content of aggregate and soil in accordance with AASHTO T 255-22 and AASHTO T 265-22. It may also be used for other construction materials.

Overview

Moisture content is determined by comparing the wet mass of a sample and the mass of the sample after drying to constant mass. The term constant mass is used to define when a sample is dry.

Constant mass – the state at which a mass does not change more than a given percent, after additional drying for a defined time interval, at a required temperature.

Apparatus

- Balance or scale: capacity sufficient for the principal sample mass, accurate to 0.1 percent of sample mass or readable to 0.1 g, and meeting the requirements of AASHTO M 231
- Containers, clean, dry, and capable of being sealed
- Suitable drying containers
- Microwave safe container with ventilated lid
- Heat source, thermostatically controlled, capable of maintaining $110 \pm 5^{\circ}\text{C}$ ($230 \pm 9^{\circ}\text{F}$).
 - Forced draft oven (preferred)
 - Ventilated oven
 - Convection oven
- Heat source, uncontrolled, for use when allowed by the agency, will not alter the material being dried, and close control of the temperature is not required:
 - Infrared heater/heat lamp, hot plate, fry pan, or any other device/method allowed by the agency .
 - Microwave oven (900 watts minimum)
- Utensils such as spoons
- Hot pads or gloves

Sample Preparation

Obtain a representative sample according to the FOP for AASHTO R 90 in its existing condition. If necessary, reduce the sample to moisture content sample size according to the FOP for AASHTO R 76.

For aggregate, the moisture content sample size is based on Table 1 or other information that may be specified by the agency.

TABLE 1
Sample Sizes for Moisture Content of Aggregate

Nominal Maximum Size* mm (in.)	Minimum Sample Mass g (lb)
150 (6)	50,000 (110)
100 (4)	25,000 (55)
90 (3 1/2)	16,000 (35)
75 (3)	13,000 (29)
63 (2 1/2)	10,000 (22)
50 (2)	8000 (18)
37.5 (1 1/2)	6000 (13)
25.0 (1)	4000 (9)
19.0 (3/4)	3000 (7)
12.5 (1/2)	2000 (4)
9.5 (3/8)	1500 (3.3)
4.75 (No. 4)	500 (1.1)

* One sieve larger than the first sieve to retain more than 10 percent of the material using an agency specified set of sieves based on cumulative percent retained. Where large gaps in specification sieves exist, intermediate sieve(s) may be inserted to determine nominal maximum.

For soils the moisture content sample size is based on Table 2 or other information that may be specified by the agency.

TABLE 2
Sample Sizes for Moisture Content of Soil

Maximum Particle Size mm (in.)	Minimum Sample Mass g
50 (2)	1000
25.0 (1)	500
12.5 (1/2)	300
4.75 (No. 4)	100
0.425 (No. 40)	10

Immediately seal or cover moisture content samples to prevent any change in moisture content or follow the steps in “Procedure.”

Procedure

Determine and record the sample mass as follows:

- For aggregate, determine and record all masses to the nearest 0.1 percent of the sample mass or to the nearest 0.1 g.
- For soil, determine and record all masses to the nearest 0.1 g.

When determining the mass of hot samples or containers or both, place and tare a buffer between the sample container and the balance. This will eliminate damage to or interference with the operation of the balance or scale.

1. Determine and record the mass of the container (and lid for microwave drying).
2. Place the wet sample in the container.
3. Determine and record the total mass of the container and wet sample.
 - a. For oven(s), hot plates, infrared heaters, etc.: Spread the sample in the container.
 - b. For microwave oven: Heap sample in the container; cover with ventilated lid.
4. Determine and record the wet mass of the sample (M_w) by subtracting the container mass determined in Step 1 from the mass of the container and sample determined in Step 3.
5. Place the sample in one of the following drying apparatuses:
 - a. For aggregate –
 - i. Controlled heat source (oven): at $110 \pm 5^\circ\text{C}$ ($230 \pm 9^\circ\text{F}$).
 - ii. Uncontrolled heat source (Hot plate, infrared heater, or other heat source as allowed by the agency): Stir frequently to avoid localized overheating.
 - b. For soil – controlled heat source (oven): at $110 \pm 5^\circ\text{C}$ ($230 \pm 9^\circ\text{F}$).

EMBANKMENT AND BASE
IN-PLACE DENSITY

WAQTC

FOP AASHTO T 255 / T 265 (22)

Note 1: Soils containing gypsum or significant amounts of organic material require special drying. For reliable moisture contents dry these soils at 60°C (140°F). For more information see AASHTO T 265, Note 2.

6. Dry until sample appears moisture free.
7. Determine mass of sample and container.
8. Determine and record the mass of the sample by subtracting the container mass determined in Step 1 from the mass of the container and sample determined in Step 7.
9. Return sample and container to the heat source for additional drying.
 - a. For aggregate –
 - i. Controlled heat source (oven): 30 minutes
 - ii. Uncontrolled heat source (Hot plate, infrared heater, or other heat source as allowed by the agency): 10 minutes
 - iii. Uncontrolled heat source (Microwave oven): 2 minutes

Caution: Some minerals in the sample may cause the aggregate to overheat, crack, and explode; altering the aggregate gradation.

- b. For soil – controlled heat source (oven): 1 hour
10. Determine mass of sample and container.
11. Determine and record the mass of the sample by subtracting the container mass determined in Step 1 from the mass of the container and sample determined in Step 10.
12. Determine percent change by subtracting the new mass determination (M_n) from the previous mass determination (M_p) divide by the previous mass determination (M_p) multiply by 100.
13. Continue drying, performing steps 9 through 12, until there is less than a 0.10 percent change after additional drying time.
14. Constant mass has been achieved; sample is defined as dry.
15. Allow the sample to cool. Immediately determine and record the total mass of the container and dry sample.
16. Determine and record the dry mass of the sample (M_D) by subtracting the mass of the container determined in Step 1 from the mass of the container and sample determined in Step 15.
17. Determine and record percent moisture (w) by subtracting the final dry mass determination (M_D) from the initial wet mass determination (M_w) divide by the final dry mass determination (M_D) multiply by 100.

Table 3
Methods of Drying

Aggregate		
Heat Source	Specific Instructions	Drying intervals to achieve constant mass (minutes)
Controlled:		
Forced draft (preferred), ventilated, or convection oven	110 ±5°C (230 ±9°F)	30
Uncontrolled:		
Hot plate, infrared heater, or any other device/method allowed by the agency	Stir frequently	10
Microwave	Heap sample and cover with ventilated lid	2
Soil		
Heat Source	Specific Instructions	Drying increments (minutes)
Controlled:		
Forced draft (preferred), ventilated, or convection oven	110 ±5°C (230 ±9°F)	1 hour

Calculation**Constant Mass**

Calculate constant mass using the following formula:

$$\% \text{ Change} = \frac{M_p - M_n}{M_p} \times 100$$

Where:

M_p = previous mass measurement

M_n = new mass measurement

Example:

Mass of container: 1232.1 g

Mass of container and sample after first drying cycle: 2637.2 g

Mass, M_p , of possibly dry sample: $2637.2 \text{ g} - 1232.1 \text{ g} = 1405.1 \text{ g}$

Mass of container and sample after second drying cycle: 2634.1 g

Mass, M_n , of sample: $2634.1 \text{ g} - 1232.1 \text{ g} = 1402.0 \text{ g}$

$$\% \text{ Change} = \frac{1405.1 \text{ g} - 1402.0 \text{ g}}{1405.1 \text{ g}} \times 100 = 0.22\%$$

0.22 percent is not less than 0.10 percent, so continue drying.

Mass of container and sample after third drying cycle: 2633.0 g

Mass, M_n , of sample: $2633.0 \text{ g} - 1232.1 \text{ g} = 1400.9 \text{ g}$

$$\% \text{ Change} = \frac{1402.0 \text{ g} - 1400.9 \text{ g}}{1402.0 \text{ g}} \times 100 = 0.08\%$$

0.08 percent is less than 0.10 percent, so constant mass has been reached.

Moisture Content:

Calculate the moisture content, as a percent, using the following formula:

$$w = \frac{M_W - M_D}{M_D} \times 100$$

where:

w = moisture content, percent

M_w = wet mass

M_D = dry mass

Example:

Mass of container: 1232.1 g

Mass of container and wet sample: 2764.7 g

Mass, M_w, of wet sample: 2764.7 g - 1232.1 g = 1532.6 g

Mass of container and dry sample (COOLED): 2633.5 g

Mass, M_D, of dry sample: 2633.5 g - 1232.1 g = 1401.4 g

$$w = \frac{1532.6 \text{ g} - 1401.4 \text{ g}}{1401.4 \text{ g}} \times 100 = \frac{131.2 \text{ g}}{1401.4 \text{ g}} \times 100 = 9.36\% \text{ report } 9.4\%$$

Report

- On forms approved by the agency
- Sample ID
- M_w, wet mass
- M_D, dry mass
- w, moisture content to the nearest 0.1 percent

EMBANKMENT AND BASE
IN-PLACE DENSITY

WAQTC

FOP AASHTO T 255 / T 265 (22)

EMBANKMENT AND BASE
IN-PLACE DENSITY

WAQTC

FOP AASHTO T 255/T 265 (18)

PERFORMANCE EXAM CHECKLIST

TOTAL EVAPORABLE MOISTURE CONTENT OF AGGREGATE BY DRYING FOP FOR AASHTO T 255

LABORATORY DETERMINATION OF MOISTURE CONTENT OF SOILS FOP FOR AASHTO T 265

Participant Name _____ Exam Date _____

Record the symbols "P" for passing or "F" for failing on each step of the checklist.

Procedure Element	Trial 1	Trial 2
1. Representative sample of appropriate mass obtained?	_____	_____
2. Mass of container determined to 0.1 g?	_____	_____
3. Sample placed in container and mass determined to 0.1 g?	_____	_____
4. Test sample mass conforms to the required mass?	_____	_____
5. Wet sample mass determined to 0.1 g?	_____	_____
6. Loss of moisture avoided prior to mass determination?	_____	_____
7. Sample dried by a suitable heat source?	_____	_____
a. Describe suitable heat sources for aggregate?	_____	_____
b. Describe suitable heat sources for soils?	_____	_____
8. If aggregate heated by means other than a controlled oven, is sample stirred to avoid localized overheating?	_____	_____
9. For microwave, aggregate heaped and covered with a ventilated lid?	_____	_____
10. For aggregate, heated for the additional, specified time?	_____	_____
a. Forced draft, ventilated, convection ovens – 30 minutes		
b. Microwave – 2 minutes		
c. Other – 10 minutes		
11. For soil:		
a. Heated for at least 1 hour additional drying time using a controlled heat source?	_____	_____
12. Mass determined and compared to previous mass - showing less than 0.10 percent loss?	_____	_____
13. Sample cooled, dry mass determined and recorded to the nearest 0.1 percent?	_____	_____
14. Moisture content calculated correctly and recorded to the nearest 0.1 percent?	_____	_____

OVER

EMBANKMENT AND BASE
IN-PLACE DENSITY

WAQTC

FOP AASHTO T 255/T 265 (18)

Comments: First attempt: Pass____Fail____ Second attempt: Pass____Fail____

Examiner Signature _____ WAQTC #: _____

ONE-POINT METHOD FOR DETERMINING MAXIMUM DRY DENSITY AND OPTIMUM MOISTURE FOP FOR AASHTO T 272

Scope

This procedure provides for a rapid determination of the maximum dry density and optimum moisture content of a soil sample, using a one-point determination in accordance with AASHTO T 272-18. This procedure is related to the FOPs for AASHTO T 99/T 180 and R 75.

One-point determinations are made by compacting the soil in a mold of a given size with a specified rammer dropped from a specified height and then compared to an individual moisture/density curve (FOP for AASHTO T 99 or T 180) or a family of curves (FOP for AASHTO R 75). Four alternate methods – A, B, C, and D – are used and correspond to the methods described in the FOP for AASHTO T 99/T 180. The method used in AASHTO T 272 must match the method used for the reference curve or to establish the family of curves. For example, when moisture-density relationships as determined by T 99 - Method C are used to form the family of curves or an individual moisture density curve, then T 99 - Method C must be used to for the one-point determination.

Apparatus

See the FOP for AASHTO T 99/T 180.

Sample

Sample size determined according to the FOP for AASHTO T 310. In cases where the existing individual curve or family cannot be used a completely new curve will need to be developed and the sample size will be determined by the FOP for AASHTO T 99/T 180.

1. If the sample is damp, dry it until it becomes friable under a trowel. Drying may be in air or by use of a drying apparatus maintained at a temperature not exceeding 60°C (140°F).
2. Thoroughly break up aggregations in a manner that avoids reducing the natural size of individual particles.
3. Pass the material through the appropriate sieve.

Procedure

Use the method matching the individual curve or Family of Curves. Refer to Table 1 of the FOP for AASHTO T 99 / T 180 for corresponding mold size, number of layers, number of blows, sieve size, and rammer specification for the various test methods.

1. Determine the mass of the clean, dry mold. Include the base plate but exclude the extension collar. Record the mass to the nearest 1 g (0.005 lb).
2. Thoroughly mix the sample with sufficient water to adjust moisture content to 80 to 100 percent of the anticipated optimum moisture.

3. Form a specimen by compacting the prepared soil in the mold (with collar attached) in approximately equal layers. For each layer:
 - a. Spread the loose material uniformly in the mold.
- Note 1:** It is recommended to cover the remaining material with a non-absorbent sheet or damp cloth to minimize loss of moisture.
- b. Lightly tamp the loose material with the manual rammer or other similar device, this establishes a firm surface.
 - c. Compact each layer with uniformly distributed blows from the rammer.
 - d. Trim down material that has not been compacted and remains adjacent to the walls of the mold and extends above the compacted surface.
 4. Remove the extension collar. Avoid shearing off the sample below the top of the mold. The material compacted in the mold should not be over 6 mm (¼ in.) above the top of the mold once the collar has been removed.
 5. Trim the compacted soil even with the top of the mold with the beveled side of the straightedge.
 6. Clean soil from exterior of the mold and base plate.
 7. Determine the mass of the mold and wet soil to the nearest 1 g (0.005 lb).
 8. Determine the wet mass of the sample by subtracting the mass in Step 1 from the mass in Step 7.
 9. Calculate the wet density (ρ_w) as indicated below under “Calculations.”
 10. Extrude the material from the mold. For soils and soil-aggregate mixtures, slice vertically through the center and remove one of the cut faces for a representative moisture content sample. For granular materials, a vertical face will not exist. Take a representative sample ensuring that all layers are represented. This sample must meet the sample size requirements of the test method used to determine moisture content.

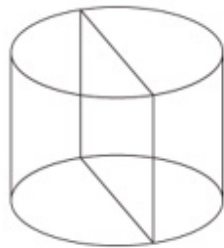
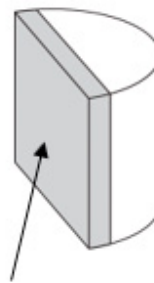
**Extruded material****Representative moisture
content sample**

11. Determine the moisture content (w) of the sample in accordance with the FOP for AASHTO T 255 / T 265.

Calculations

1. Calculate the wet density, in kg/m^3 (lb/ft^3), by dividing the wet mass by the measured volume of the mold (T 19).

Example – Methods A or C mold:

Wet mass = 2.0055 kg (4.42 lb)

Measured volume of the mold = 0.0009469 m^3 (0.0334 ft^3)

$$\rho_w = \frac{2.0055 \text{ kg}}{0.0009469 \text{ m}^3} = 2118 \text{ kg/m}^3$$

$$\rho_w = \frac{4.42 \text{ lb}}{0.0334 \text{ ft}^3} = 132.2 \text{ lb/ft}^3$$

Where:

$$\rho_w = \text{Wet density, kg/m}^3 \text{ (lb/ft}^3\text{)}$$

2. Calculate the dry density as follows.

$$\rho_d = \left(\frac{\rho_w}{w + 100} \right) \times 100 \quad \text{or} \quad \rho_d = \frac{\rho_w}{\left(\frac{w}{100} \right) + 1}$$

Where:

$$\rho_d = \text{Dry density, kg/m}^3 \text{ (lb/ft}^3\text{)}$$

w = Moisture content, as a percentage

Example:

$$\rho_w = 2118 \text{ kg/m}^3 \text{ (132.2 lb/ft}^3\text{)}$$

$$w = 13.5\%$$

$$\rho_d = \left(\frac{2118 \text{ kg/m}^3}{13.5 + 100} \right) \times 100 = 1866 \text{ kg/m}^3 \quad \rho_d = \left(\frac{132.2 \text{ lb/ft}^3}{13.5 + 100} \right) \times 100 = 116.5 \text{ lb/ft}^3$$

or

$$\rho_d = \left(\frac{2118 \text{ kg/m}^3}{\frac{13.5}{100} + 1} \right) = 1866 \text{ kg/m}^3 \quad \rho_d = \left(\frac{132.2 \text{ lb/ft}^3}{\frac{13.5}{100} + 1} \right) = 116.5 \text{ lb/ft}^3$$

Maximum Dry Density and Optimum Moisture Content Determination Using an Individual Moisture / Density Curve

1. The moisture content must be within 80 to 100 percent of optimum moisture of the reference curve. Compact another specimen, using the same material, at an adjusted moisture content if the one-point does not fall in the 80 to 100 percent of optimum moisture range.
2. Plot the one-point, dry density on the vertical axis and moisture content on the horizontal axis, on the reference curve graph.
3. If the one-point falls on the reference curve or within ± 2.0 lbs/ft³, use the maximum dry density and optimum moisture content determined by the curve.
4. Use the FOP for AASHTO T 99/T 180 Annex A to determine corrected maximum dry density and optimum moisture content if oversize particles have been removed.
5. Perform a full moisture-density relationship if the one-point does not fall on or within ± 2.0 lbs/ft³ of the reference curve at 80 to 100 percent optimum moisture.

Example

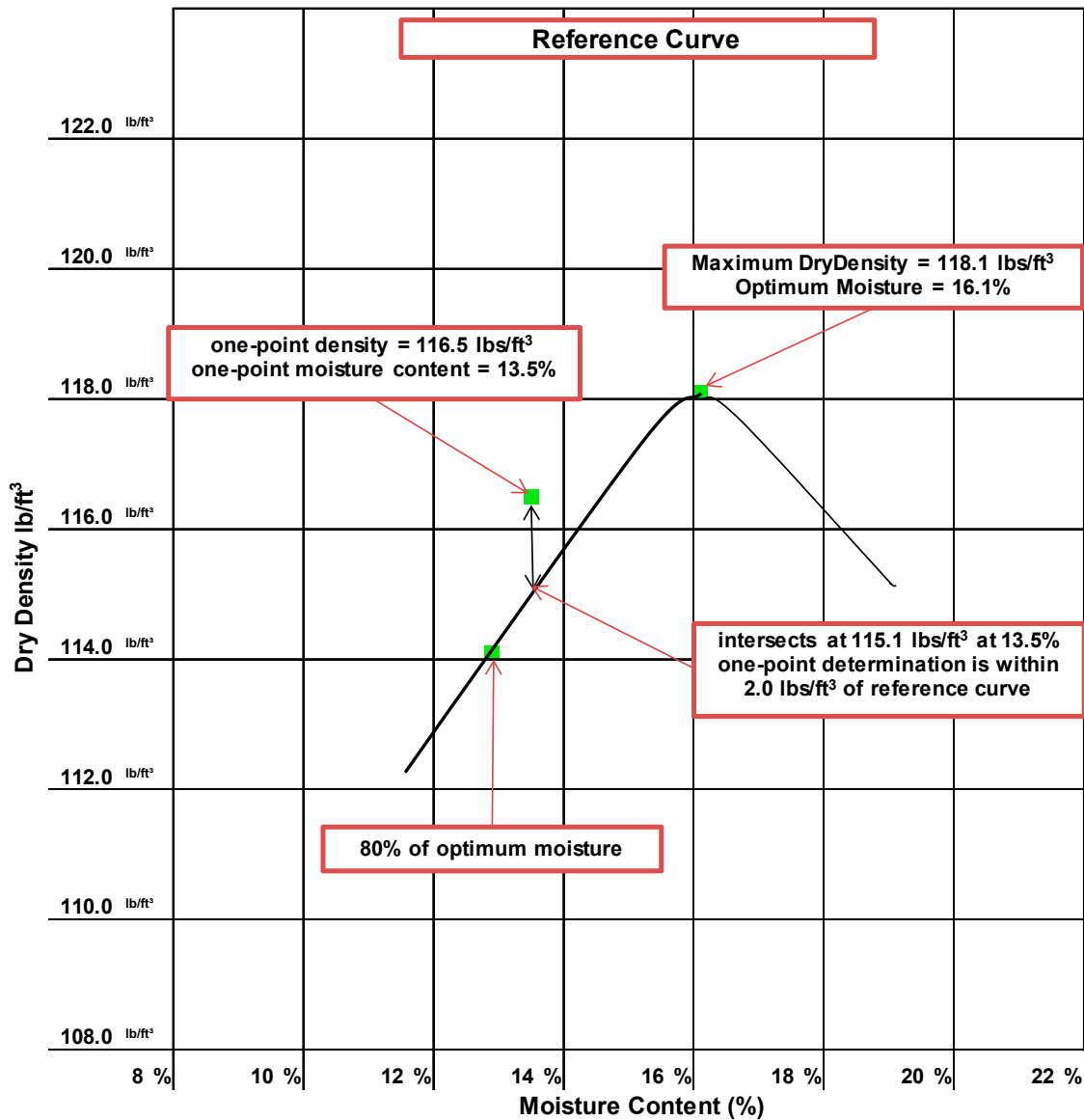

The results of a one-point determination were 116.5 lb/ft³ at 13.5 percent moisture. The point was plotted on the reference curve graph. The one-point determination is within 2.0 lb/ft³ of the point on the curve that corresponds with the moisture content.

Maximum Dry Density and Optimum Moisture Content Determination Using a Family of Curves

1. Plot the one-point, dry density on the vertical axis and moisture content on the horizontal axis, on the reference family of curves graph.
2. If the moisture-density one-point falls on one of the curves in the family of curves, use the maximum dry density and optimum moisture content defined by that curve.
3. If the moisture-density one-point falls within the family of curves but not on an existing curve, draw a new curve through the plotted single point, parallel and in character with the nearest existing curve in the family of curves. Use the maximum dry density and optimum moisture content as defined by the new curve.
 - a. The one-point must fall either between or on the highest or lowest curves in the family. If it does not, then a full curve must be developed.
 - b. If the one-point plotted within or on the family of curves does not fall in the 80 to 100 percent of optimum moisture content, compact another specimen, using the same material, at an adjusted moisture content that will place the one point within this range.
4. Use the FOP for AASHTO T 99/T 180 Annex A to determine corrected maximum dry density and optimum moisture content if oversize particles have been removed.
5. If the new curve through a one-point is not well defined or is in any way questionable, perform a full moisture-density relationship to correctly define the new curve and verify the applicability of the family of curves.

Note 2: New curves drawn through plotted single point determinations shall not become a permanent part of the family of curves until verified by a full moisture-density procedure following the FOP for AASHTO T 99/T 180.

Example

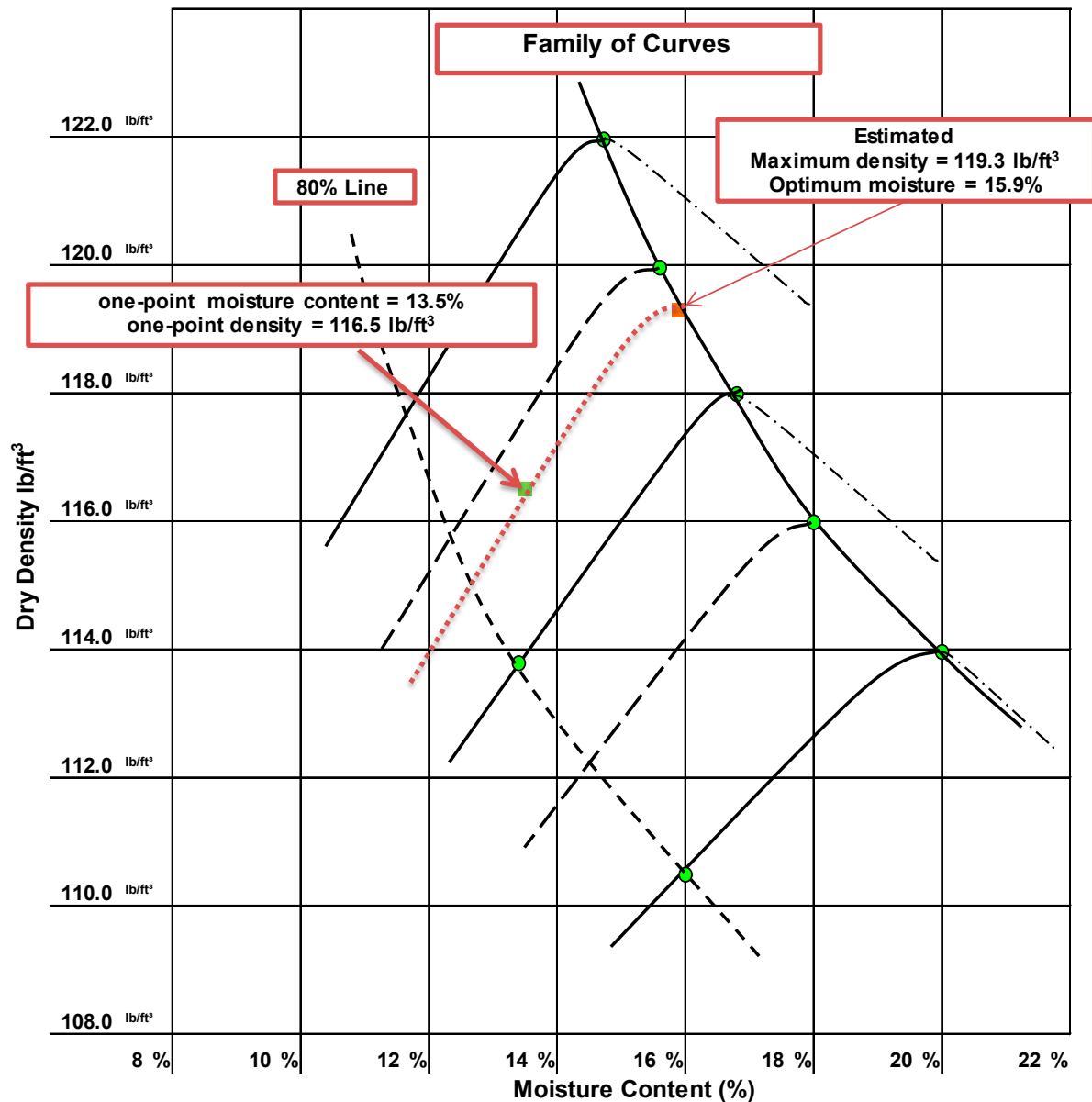

The results of a one-point determination were 116.5 lb/ft³ at 13.5 percent moisture. The point was plotted on the reference curve graph. The point was plotted on the appropriate family between two previously developed curves near and intermediate curve.

The “dotted” curve through the moisture-density one-point was sketched between the existing curves. A maximum dry density of 119.3 lb/ft³ and a corresponding optimum moisture content of 15.9 percent were estimated.

EMBANKMENT AND BASE
IN-PLACE DENSITY

WAQTC

FOP AASHTO T 272 (21)

Report

- On forms approved by the agency
- Sample ID
- Maximum dry density to the nearest 1 kg/m^3 (0.1 lb/ft^3)
- Corrected maximum dry density (if applicable)
- Optimum moisture content to the nearest 0.1 percent
- Corrected optimum moisture content (if applicable)
- Reference curve or Family of Curves used

EMBANKMENT AND BASE
IN-PLACE DENSITY

WAQTC

FOP AASHTO T 272 (18)

PERFORMANCE EXAM CHECKLIST

ONE-POINT METHOD FOP FOR AASHTO T 272 (T 180)

Participant Name _____ Exam Date _____

Record the symbols "P" for passing or "F" for failing on each step of the checklist.

Procedure Element	Trial 1	Trial 2
1. One-point determination of dry density and corresponding moisture content made in accordance with the FOP for AASHTO T 180?	_____	_____
a. Correct size (4.75 mm / No. 4 or 19.0 mm / 3/4 in.) material used?	_____	_____
2. If necessary, sample dried until friable in air or drying apparatus, not exceeding 60°C (140°F)?	_____	_____
3. Sample broken up and an adequate amount sieved over the appropriate sieve (4.75 mm / No. 4 or 19.0 mm / 3/4 in.) to determine oversize (coarse particle) percentage?	_____	_____
4. Sample passing the sieve has appropriate mass?	_____	_____
5. Moisture content adjusted if needed?	_____	_____
6. Determine mass of clean, dry mold without collar to nearest 1 g (0.005 lb.)?	_____	_____
7. Mold placed on rigid and stable foundation?	_____	_____
8. Layer of soil (approximately one fifth compacted depth) placed in mold with collar attached, loose material lightly tamped?	_____	_____
9. Soil compacted with appropriate number of blows (25 or 56)?	_____	_____
10. Material adhering to the inside of the mold trimmed?	_____	_____
11. Layer of soil (approximately two fifths compacted depth) placed in mold with collar attached, loose material lightly tamped?	_____	_____
12. Soil compacted with appropriate number of blows (25 or 56)?	_____	_____
13. Material adhering to the inside of the mold trimmed?	_____	_____
14. Layer of soil (approximately three fifths compacted depth) placed in mold with collar attached, loose material lightly tamped?	_____	_____
15. Soil compacted with appropriate number of blows (25 or 56)?	_____	_____
16. Material adhering to the inside of the mold trimmed?	_____	_____
17. Layer of soil (approximately four fifths compacted depth) placed in mold with collar attached, loose material lightly tamped?	_____	_____
18. Soil compacted with appropriate number of blows (25 or 56)?	_____	_____
19. Material adhering to the inside of the mold trimmed?	_____	_____

OVER

EMBANKMENT AND BASE
IN-PLACE DENSITY

WAQTC

FOP AASHTO T 272 (18)

Procedure Element	Trial 1	Trial 2
20. Mold filled with soil such that compacted soil will be above the mold, loose material lightly tamped?	_____	_____
21. Soil compacted with appropriate number of blows (25 or 56)?	_____	_____
22. Collar removed without shearing off sample?	_____	_____
23. Approximately 6 mm (1/4 in.) of compacted material above the top of the mold (without the collar)?	_____	_____
24. Soil trimmed to top of mold with the beveled side of the straightedge?	_____	_____
25. Remove soil from exterior surface of mold and base plate?	_____	_____
26. Mass of mold and contents determined to appropriate precision?	_____	_____
27. Wet density calculated from the wet mass?	_____	_____
28. Soil removed from mold using a sample extruder if needed?	_____	_____
29. Soil sliced vertically through center (non-granular material)?	_____	_____
30. Moisture sample removed ensuring all layers are represented?	_____	_____
31. Moist mass determined immediately to 0.1 g?	_____	_____
32. Moisture sample mass of correct size?	_____	_____
33. Sample dried and water content determined according to the FOP for T 255/T 265?	_____	_____
34. One-point plotted on family of curves supplied?	_____	_____
a. One-point falls within 80 to 100 percent of optimum moisture content in order to be valid?	_____	_____
b. If one-point does not fall within 80 to 100 percent of optimum moisture content, another one-point determination with an adjusted water content is made?	_____	_____
c. Maximum dry density and corresponding optimum moisture content correctly estimated?	_____	_____
35. One-point plotted on a single reference curve?	_____	_____
a. Does one-point plot within 2 lb/ft ³ in order to be valid?	_____	_____
b. Does one-point fall within 80 to 100 percent of optimum moisture content in order to be valid?	_____	_____
c. Maximum dry density and corresponding optimum moisture content determined from single reference curve?	_____	_____

Comments: First attempt: Pass_____Fail_____ Second attempt: Pass_____Fail_____

Examiner Signature _____ WAQTC #: _____

PERFORMANCE EXAM CHECKLIST

**ONE-POINT METHOD
FOP FOR AASHTO T 272 (T 99)**

Participant Name _____ Exam Date _____

Record the symbols “P” for passing or “F” for failing on each step of the checklist.

Procedure Element	Trial 1	Trial 2
1. One-point determination of dry density and corresponding moisture content made in accordance with the FOP for AASHTO T 99?	_____	_____
a. Correct size (4.75 mm / No. 4 or 19.0 mm / 3/4 in.) material used?	_____	_____
2. If necessary, sample dried until friable in air or drying apparatus, not exceeding 60°C (140°F)?	_____	_____
3. Sample broken up and an adequate amount sieved over the appropriate sieve (4.75 mm / No. 4 or 19.0 mm / 3/4 in.) to determine oversize (coarse particle) percentage?	_____	_____
4. Sample passing the sieve has appropriate mass?	_____	_____
5. Moisture content adjusted if needed?	_____	_____
6. Determine mass of clean, dry mold without collar to nearest 1 g (0.005 lb.)?	_____	_____
7. Mold placed on rigid and stable foundation?	_____	_____
8. Layer of soil (approximately one third compacted depth) placed in mold with collar attached, loose material lightly tamped?	_____	_____
9. Soil compacted with appropriate number of blows (25 or 56)?	_____	_____
10. Material adhering to the inside of the mold trimmed?	_____	_____
11. Layer of soil (approximately two thirds compacted depth) placed in mold with collar attached, loose material lightly tamped?	_____	_____
12. Soil compacted with appropriate number of blows (25 or 56)?	_____	_____
13. Material adhering to the inside of the mold trimmed?	_____	_____
14. Mold filled with soil such that compacted soil will be above the mold, loose material lightly tamped?	_____	_____
15. Soil compacted with appropriate number of blows (25 or 56)?	_____	_____
16. Collar removed without shearing off sample?	_____	_____
17. Approximately 6 mm (1/4 in.) of compacted material above the top of the mold (without the collar)?	_____	_____
18. Soil trimmed to top of mold with the beveled side of the straightedge?	_____	_____
19. Remove soil from exterior surface of mold and base plate?	_____	_____
20. Mass of mold and contents determined to appropriate precision?	_____	_____

OVER

WSDOT Errata to FOP for AASHTO T 304

Uncompacted Void Content of Fine Aggregate

WAQTC FOP for AASHTO T 304 has been adopted by WSDOT with the following changes:

Report

Replace first bullet with below:

- The Uncompacted Voids (U_m) in percent to the nearest 1 percent.

UNCOMPACTED VOID CONTENT OF FINE AGGREGATE FOP FOR AASHTO T 304

Scope

This procedure covers the determination of the loose uncompacted void content of a sample of fine aggregate in accordance with AASHTO T 304-17. When measured on an aggregate of a known grading, void content indicates the aggregate's angularity, sphericity, and surface texture compared with other fine aggregates tested in the same grading. When void content is measured on an as-received fine aggregate grading, it can indicate the effect of the fine aggregate on the workability of a mixture in which it is used.

Apparatus

- Cylindrical Measure – approximately 100 mL right cylinder made of seamless smooth wall metal, inside diameter approximately 39 mm and inside height approximately 86 mm, with a metal bottom at least 6 mm thick, which is firmly sealed to the cylinder with means for aligning the axis of the cylinder with that of the funnel (see Figure 1).
- Funnel – the lateral surface of the right frustum of a smooth metal cone at least 38 mm high sloped 60 ± 4 degrees from the horizontal with an opening of 12.7 ± 0.6 mm diameter with a volume of at least 200 mL or with a supplemental glass or metal container to provide the required volume (see Figure 2).
- Funnel Stand – A three or four-legged support capable of holding the funnel firmly in position 115 ± 2 mm above the top of the cylinder with the axis of the funnel colinear (within a 4 degree angle and a displacement of 2 mm) with the axis of the cylindrical measure. A suitable arrangement is shown in Figure 2.
- Glass Plate – minimum 4 mm thick, approximately 60 mm by 60 mm used to calibrate the cylindrical measure.
- Pan – flat metal or plastic pan of sufficient size to contain the funnel stand and to prevent loss of material.
- Metal spatula with a straight edged blade approximately 100 mm long, and at least 20 mm wide with an end cut at a right angle to the edges.
- Scale or balance accurate and readable to ± 0.1 g within the range of use, capable of weighing the cylindrical measure and its contents.

Figure 1

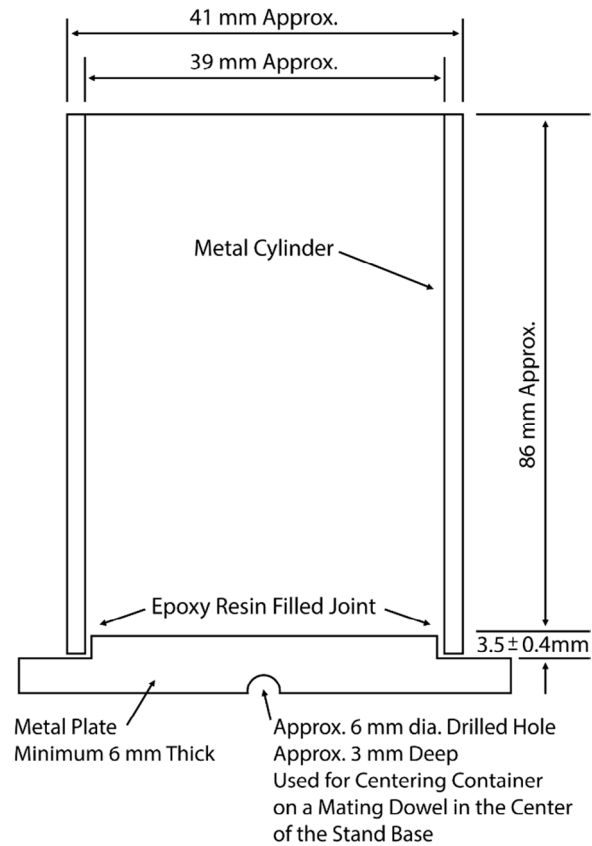
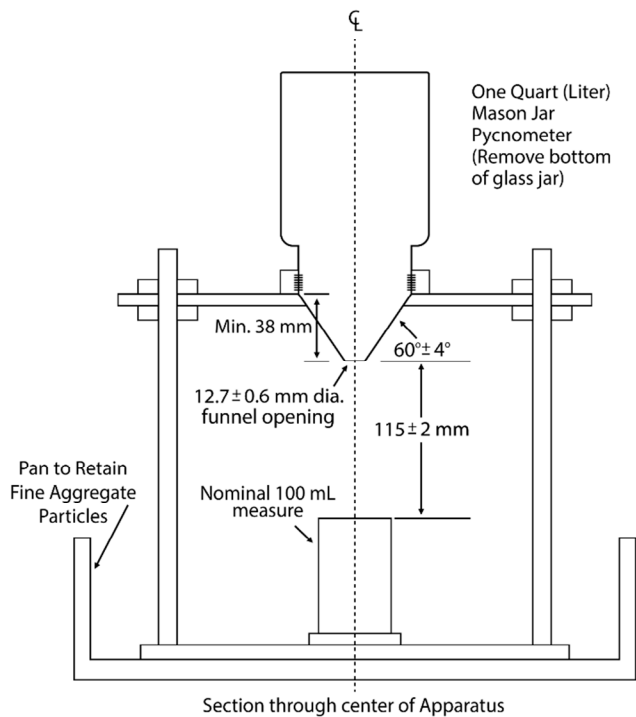

Figure 2



Preparation of Test Samples

Obtain the standard graded sample from one of the following:

1. Use the sieve analysis samples from the FOP for AASHTO T 27/11.
2. Store the dry separate size fractions obtained from one (or more) sieve analysis in separate containers for each size.

OR:

1. Obtain sample according to the FOP for AASHTO R 90
2. Reduce according to the FOP for AASHTO R 76
3. Wash sample over a 150- μm (No. 100) or 75- μm (No. 200) sieve according to FOP for AASHTO T 27/11.
4. Dry to constant mass according to the FOP for AASHTO T 255.
5. Using sieves in Table 1, separate into individual size fractions according to FOP for AASHTO T 27/11
6. Weigh out and combine the following quantities of material identified in Table 1.

Table 1

Individual Size Fraction		
Passing	Retained On	Mass g
No. 8 (2.36 mm)	No. 16 (1.18 mm)	44.0 \pm 0.2
No. 16 (1.18 mm)	No. 30 (600 μm)	57.0 \pm 0.2
No. 30 (600 μm)	No. 50 (300 μm)	72.0 \pm 0.2
No. 50 (300 μm)	No. 100 (150 μm)	17.0 \pm 0.2
	Total	190.0 \pm 0.2

Specific Gravity of Fine Aggregate

The fine aggregate bulk specific gravity (G_{sb}) is used to determine the uncompacted void content. Use the G_{sb} from the source if it is known. If it is unknown determine the G_{sb} on the minus No. 4 (4.75 mm) material according to AASHTO T 84.

If the G_{sb} of some size fractions differ by more than 0.05 from the G_{sb} typical of the complete sample, the G_{sb} of the fraction (or fractions) being tested must be determined.

Note 1: An indicator of differences in specific gravity of various particle sizes is a comparison of specific gravities run on the fine aggregate in different gradings. Specific gravity can be run on gradings with and without specific size fractions of interest. If specific gravity differences exceed 0.05, determine the specific gravity of the individual 2.36 mm (No. 8) to 150 μ m (No. 100) sizes for use either by direct measurement or by calculation using the specific gravity data on gradings with and without the size fraction of interest. A difference in specific gravity of 0.05 will change the calculated void content about 1 percent.

Procedure

1. Record the mass of the empty measure to the nearest 0.1 g.
2. Mix test sample with the spatula until it appears to be homogeneous.
3. Position the jar and funnel section in the stand and center the cylindrical measure as shown in Figure 2.
4. Using a finger, block the opening of the funnel, pour the test sample into the funnel.
5. Level the material in the funnel with the spatula.
6. Withdraw finger allowing the sample to freely flow into the cylindrical measure.
7. After the funnel empties, strike-off excess fine aggregate from the cylindrical measure with a rapid single pass of the spatula with the width of the blade vertical using the straight part of its edge in light contact with the top of the measure.

Until strike-off is complete, avoid vibration or disturbance which could cause compaction of the material in the measure.

Note 2: After strike-off, the cylindrical measure may be tapped lightly to compact the sample to make it easier to transfer the container to scale or balance without spilling any of the sample.

8. Brush adhering grains from the outside of the container
9. Determine and record the mass of the cylindrical measure and contents to the nearest 0.1 g.
10. Recombine the sample from the pan and cylindrical measure
11. Stir until homogenous
12. Repeat Steps 3 through 9.
13. Determine net mass of aggregate in measure by subtracting mass of the measure from the mass of measure and fine aggregate.
14. Calculate the uncompacted void content (U_s) of each determination to the nearest 0.1 percent.
15. Average the results of the two determinations (U_m) to the nearest 0.1 percent.

Calculations

Calculate the uncompacted voids for each determination:

$$U_s = \frac{V - \left(\frac{F}{G_{sb}}\right)}{V} \times 100$$

Where:

U_s = uncompacted voids in the material to the nearest 0.1 percent

V = volume of cylindrical measure, mL

F = net mass, g, of fine aggregate in measure

G_{sb} = Bulk dry specific gravity of fine aggregate;

Calculate the average uncompacted voids for the two determinations:

$$U_m = \frac{U_1 + U_2}{2}$$

Where:

U_m = the average uncompacted void content to the nearest 0.1 percent

U_1 = first determination

U_2 = second determination

Example:

$$U_s = \frac{99.8 \text{ mL} - \left(\frac{146.2 \text{ g}}{2.636}\right)}{99.8 \text{ mL}} \times 100 = 44.4\%$$

Where:

U_s = uncompacted voids in the material to the nearest 0.1 percent

V = 99.8 mL

F = 146.2 g

G_{sb} = 2.636

The average uncompacted voids for the two determinations:

$$U_m = \frac{48.7\% + 49.9\%}{2} = 49.3\%$$

Where:

U_m = the average uncompacted void content to the nearest 0.1 percent

U_1 = 48.7%

U_2 = 49.9%

Report

- The Uncompacted Voids (U_m) in percent to the nearest 0.1 percent.
- The specific gravity value used in the calculations.

ANNEX — CALIBRATION OF CYLINDRICAL MEASURE

(Mandatory Information)

1. Apply a light coat of grease to the top edge of the dry, empty cylindrical measure.
2. Determine the mass of the measure, grease, and glass plate to the nearest 0.1 g.
3. Fill the measure with freshly boiled, deionized water at a temperature of 18 to 24°C (64.4 to 75.2°F).
4. Record the temperature of the water.
5. Place the glass plate on the measure, being sure that no air bubbles remain.
6. Dry the outer surfaces of the measure.
7. Determine the combined mass of measure, glass plate, grease, and water to the nearest 0.1 g.

Calculations

Calculate the volume of the measure as follows:

$$V = 1000 \times \frac{M}{D}$$

Where:

- V = volume of cylinder, to the nearest 0.1 mL
M = net mass of water, g
D = density of water kg/m³ (see Table B1 in the FOP for AASHTO T 99/T 180 for density at the temperature used)

Example

$$V = 1000 \times \frac{99.6}{997.99} = 99.8 \text{ mL}$$

Where:

- V = volume of cylinder, to the nearest 0.1 mL
M = 99.6 g
D = 997.99 kg/m³, density of water at 21°C (69.8°F)

Performance Exam Checklist

UNCOMPACTED VOID CONTENT OF FINE AGGREGATE

FOP FOR AASHTO T 304

Participant Name _____ Exam Date _____

Record the symbols “P” for passing or “F” for failing on each step of the checklist.

Preparation of Test Samples

Trial 1 Trial 2

- | | | |
|--|-------|-------|
| 1. Sample obtained per FOP for AASHTO R 90? | _____ | _____ |
| 2. Sample reduced to testing size per FOP for AASHTO R 76? | _____ | _____ |
| 3. Sample washed over 150- μ m (No. 100) or 75- μ m (No. 200) sieve in accordance with FOP for AASHTO T 27_T 11? | _____ | _____ |
| 4. Sample dried to constant mass? | _____ | _____ |
| 5. Separated into individual size fractions? | _____ | _____ |
| 6. Material weighed out and combined per Table 1? | _____ | _____ |
| 7. Fine aggregate bulk specific gravity (G_{sb}) determined according to procedure? | _____ | _____ |

Procedure Element

Trial 1 Trial 2

- | | | |
|---|-------|-------|
| 8. Cylindrical measure calibrated according to Annex? | _____ | _____ |
| 9. Mass of empty measure recorded to nearest 0.1 g? | _____ | _____ |
| 10. Test sample mixed until it appears homogeneous? | _____ | _____ |
| 11. Cylindrical measure centered on stand per Figure 2? | _____ | _____ |
| 12. Finger used to block funnel opening? | _____ | _____ |
| 13. Test sample poured in funnel and leveled with spatula? | _____ | _____ |
| 14. Finger withdrawn and sample allowed to freely flow into cylindrical measure? | _____ | _____ |
| 15. After funnel empties, excess material struck off with spatula correctly? | _____ | _____ |
| 16. Care taken to avoid any vibration or disturbance? | _____ | _____ |
| 17. Adhering grains brushed off before weighing the cylindrical measure? | _____ | _____ |
| 18. Mass of the cylindrical measure and contents determined to nearest 0.1 g? | _____ | _____ |
| 19. Sample recombined and stirred until homogenous? | _____ | _____ |
| 20. Procedure Steps 3 through 9 repeated? | _____ | _____ |
| 21. Uncompacted void content (U_s) calculated for each determination to nearest 0.1 percent? | _____ | _____ |
| 22. Results of both determinations (U_m) averaged to nearest 0.1 percent and reported to the nearest 1 percent? | _____ | _____ |

First Attempt: Pass Fail Second Attempt: Pass Fail

Signature of Examiner _____

Comments:

WSDOT Errata to FOP for AASHTO T 308

Determining the Asphalt Binder Content of Asphalt Mixtures by the Ignition Method

WAQTC FOP for AASHTO T 308 has been adopted by WSDOT with the following changes:

Procedure – Method B (External Balance) – *Method not recognized by WSDOT.*

Annex – Correction Factors

Asphalt Binder and Aggregate

Asphalt binder correction factor – *Shall read as below:*

A correction factor must be established by testing a set of correction specimens for each Job Mix Formula (JMF).

Aggregate correction factor – *Method not recognized by WSDOT.*

Procedure

Steps 9 – 13 not recognized by WSDOT.

DETERMINING THE ASPHALT BINDER CONTENT OF ASPHALT MIXTURES BY THE IGNITION METHOD FOP FOR AASHTO T 308

Scope

This procedure covers the determination of asphalt binder content of asphalt mixtures by ignition of the binder in accordance with AASHTO T 308-22.

Overview

The sample is heated in a furnace at 538°C (1000°F) or less; samples may be heated by convection or direct infrared irradiation (IR). The aggregate remaining after burning can be used for sieve analysis using the FOP for AASHTO T 30.

Some agencies allow the use of recycled asphalt mixtures. When using recycled asphalt mixtures, check with the agency for specific correction procedures.

Asphalt binder in the asphalt mixture is ignited in a furnace. Asphalt binder content is calculated as the percentage difference between the initial mass of the asphalt mixture and the mass of the residual aggregate, with the asphalt binder correction factor, and moisture content subtracted. The asphalt binder content is expressed as percent of moisture-free mix mass.

Two methods, A and B, are presented.

Apparatus

Note 1: The apparatus must be calibrated for the specific mix design. See “Correction Factors” at the end of this FOP.

The apparatus for the Methods A and B is the same except that the furnace for Method A requires an internal balance.

- **Ignition Furnace:** A forced-air ignition furnace that heats the specimens by either the convection or direct IR irradiation method. The convection-type furnace must be capable of maintaining the temperature between at least 530 and 545°C (986 and 1013°F) and have a temperature control accurate within $\pm 5^{\circ}\text{C}$ ($\pm 9^{\circ}\text{F}$).

For Method A, the furnace will be equipped with an internal scale thermally isolated from the furnace chamber and accurate to 0.1 g. The scale shall be capable of determining the mass of a 3500 g sample in addition to the sample baskets. A data collection system will be included so that mass can be automatically determined and displayed during the test. The furnace shall have a built-in computer program to calculate the change in mass of the sample and provide for the input of a correction factor for aggregate loss. The furnace shall provide a printed ticket with the initial specimen mass, specimen mass loss, temperature compensation, correction factor, corrected asphalt binder content, test time, and test temperature. The furnace shall provide an audible alarm and indicator light when the sample mass loss does not exceed 0.01 percent of the total sample mass for three consecutive minutes. Perform lift test according to manufacturer’s instructions weekly during use, if applicable. The furnace shall be

designed to permit the operator to change the ending mass loss percentage from both 0.01 percent to 0.02 percent.

For both Method A and Method B, the furnace chamber dimensions shall be adequate to accommodate a 3500 g sample. The furnace door shall be equipped so that it cannot be opened during the ignition test. A method for reducing furnace emissions shall be provided and the furnace shall be vented so that no emissions escape into the laboratory. The furnace shall have a fan to pull air through the furnace to expedite the test and to eliminate the escape of smoke into the laboratory.

- **Sample Basket Assembly:** consisting of sample basket(s), catch pan, and basket guards. Sample basket(s) will be of appropriate size allowing samples to be thinly spread and allowing air to flow through and around the sample particles. Sets of two or more baskets shall be nested. A catch pan: of sufficient size to hold the sample basket(s) so that aggregate particles and melting asphalt binder falling through the screen mesh are caught. Basket guards will completely enclose the basket and be made of screen mesh, perforated stainless steel plate, or other suitable material.
- Thermometer, or other temperature measuring device, with a temperature range of 10 - 260°C (50-500°F).
- Oven capable of maintaining 110 ±5°C (230 ±9°F).
- Balance or scale: Capacity sufficient for the sample mass and conforming to the requirements of M 231, Class G2.
- **Safety equipment:** Safety glasses or face shield, high temperature gloves, long sleeved jacket, a heat resistant surface capable of withstanding 650°C (1202°F), a protective cage capable of surrounding the sample baskets during the cooling period, and a particle mask for use during removal of the sample from the basket assembly.
- **Miscellaneous equipment:** A container larger than the sample basket(s) for transferring sample after ignition, large flat pan, spatulas, bowls, and wire brushes.

Sampling

1. Obtain samples of asphalt mixture in accordance with the FOP for AASHTO R 97.
2. Reduce asphalt mixture samples in accordance with the FOP for AASHTO R 47.
3. If the mixture is not sufficiently soft to separate with a spatula or trowel, place it in a large flat pan in an oven at 110 ±5°C (230 ±9°F) until soft enough.
4. Test sample size shall conform to the mass requirement shown in Table 1.

Note 2: When the mass of the test specimen exceeds the capacity of the equipment used or for large samples of fine mixes, the test specimen may be divided into suitable increments, tested, and the results appropriately combined through a weighted average for calculation of the asphalt binder content.

Table 1

Nominal Maximum Aggregate Size* mm (in.)	Minimum Mass Specimen g	Maximum Mass Specimen g
37.5 (1 ½)	4000	4500
25.0 (1)	3000	3500
19.0 (¾)	2000	2500
12.5 (½)	1500	2000
9.5 (¾)	1200	1700
4.75 (No. 4)	1200	1700

* One sieve larger than the first sieve to retain more than 10 percent of the material using an agency specified set of sieves based on cumulative percent retained. Where large gaps in specification sieves exist, intermediate sieve(s) may be inserted to determine nominal maximum size.

Procedure – Method A (Internal Balance)

1. For the convection-type furnace, preheat the ignition furnace to $538 \pm 5^{\circ}\text{C}$ ($1000 \pm 9^{\circ}\text{F}$) or to the temperature determined in the Correction Factors Annex of this method. Manually record the furnace temperature (set point) before the initiation of the test if the furnace does not record automatically. For the direct IR irradiation-type furnace, use the same burn profile as used during the correction factor determination.
2. Dry the sample to constant mass, according to the FOP for AASHTO T 329; or determine the moisture content of a companion sample in accordance with the FOP for AASHTO T 329.
3. Determine and record the mass of the sample basket assembly to the nearest 0.1 g.
4. Evenly distribute the sample in the sample basket assembly, taking care to keep the material away from the edges of the basket. Use a spatula or trowel to level the sample.
5. Determine and record the total mass of the sample and sample basket assembly at room temperature to the nearest 0.1 g.
6. Calculate the initial mass of the sample by subtracting the mass of the sample basket from the mass of the sample and sample basket assembly and record to the nearest 0.1 g. Designate this mass as (M_i).
7. Record the correction factor or input into the furnace controller for the specific asphalt mixture.
8. Input the initial mass of the sample (M_i) into the ignition furnace controller. Verify that the correct mass has been entered.
9. Verify the furnace scale is reading zero, if not, reset to zero.

CAUTION: Operator should wear safety equipment – high temperature gloves, face shield, fire-retardant shop coat – when opening the door to load or unload the sample.

10. Open the chamber door and gently set the sample basket assembly in the furnace. Carefully position the sample basket assembly so it is not in contact with the furnace wall. Close the chamber door and verify that the sample mass displayed on the furnace scale equals the total mass of the sample and sample basket assembly recorded in Step 5 within ± 5 g.

Note 3: Differences greater than 5 g or failure of the furnace scale to stabilize may indicate that the specimen basket assembly is contacting the furnace wall.

Note 4: Furnace temperature will drop below the set point when the door is opened but will recover when the door is closed, and ignition begins. Sample ignition typically increases the temperature well above the set point – relative to sample size and asphalt binder content.

11. Initiate the test by pressing the start button. This will lock the sample chamber and start the combustion blower.

Safety note: Do not attempt to open the furnace door until the asphalt binder has been completely burned off.

12. Allow the test to continue until the stable light and audible stable indicator indicate that the change in mass does not exceed 0.01 percent for three consecutive minutes. Press the stop button. This will unlock the sample chamber and cause the printer to print out the test results.

Note 5: An ending mass loss percentage of 0.02 may be used, if allowed by the agency, when aggregate that exhibits an excessive amount of loss during ignition testing is used.

13. Open the chamber door, remove the sample basket assembly, and place on the cooling plate or block. Place the protective cage over the sample basket assembly and allow it to cool to room temperature (approximately 30 minutes).

14. Determine and record the mass of the sample and sample basket assembly after ignition to the nearest 0.1 g.

15. Calculate the mass of the sample by subtracting the mass of the sample basket assembly from the mass of the sample and sample basket assembly and record to the nearest 0.1 g. Designate this mass as M_f .

16. Use the asphalt binder content percentage from the printed ticket. Subtract the moisture content and the correction factor if not entered into the furnace controller from the printed ticket asphalt binder content and report the difference as the corrected asphalt binder content.

Asphalt binder content percentage can also be calculated using the formula from “Method B” Step 16.

Calculation

Corrected asphalt binder content:

$$P_b = BC - MC - C_f^*$$

*If correction factor is not entered into the furnace controller

where:

P_b = the corrected asphalt binder content as a percent by mass of the asphalt mixture

BC = asphalt binder content shown on printed ticket

MC = moisture content of the companion asphalt mixture sample, percent, as determined by the FOP for AASHTO T 329 (if the specimen was oven-dried before initiating the procedure, MC=0)

C_f = correction factor as a percent by mass of the asphalt mixture sample

Procedure – Method B (External Balance)

1. Preheat the ignition furnace to $538 \pm 5^\circ\text{C}$ ($1000 \pm 9^\circ\text{F}$) or to the temperature determined in the Correction Factor Annex of this method. Manually record the furnace temperature (set point) before the initiation of the test if the furnace does not record automatically.
2. Dry the sample to constant mass, according to the FOP for AASHTO T 329; or determine the moisture content of a companion sample in accordance with the FOP for AASHTO T 329.
3. Determine and record the mass of the sample basket assembly to the nearest 0.1 g.
4. Place the sample basket(s) in the catch pan. Evenly distribute the sample in the sample basket(s), taking care to keep the material away from the edges of the basket. Use a spatula or trowel to level the sample.
5. Determine and record the mass of the sample and sample basket assembly at room temperature to the nearest 0.1 g.
6. Calculate the initial mass of the sample by subtracting the mass of the sample basket from the mass of the sample and sample basket assembly and record to the nearest 0.1 g. Designate this mass as (M_i).
7. Record the correction factor for the specific asphalt mixture.
8. Open the chamber door and gently set the sample basket assembly in the furnace. Carefully position the sample basket assembly so it is not in contact with the furnace wall. Burn the asphalt mixture sample in the furnace for 45 minutes or the length of time determined in the “Correction Factors” section.

ASPHALT

WAQTC

FOP AASHTO T 308 (22)

9. Open the chamber door, remove the sample basket assembly, and place on the cooling plate or block. Place the protective cage over the sample and allow it to cool to room temperature (approximately 30 min).
10. Determine and record the mass of the sample and sample basket assembly to the nearest 0.1 g.
11. Calculate the sample mass by subtracting the mass of the sample basket assembly from the mass of the sample and sample basket assembly and record to the nearest 0.1 g.
12. Place the sample basket assembly back into the furnace.
13. Burn the sample for at least 15 minutes after the furnace reaches the set temperature.
14. Open the chamber door, remove the sample basket assembly, and place on the cooling plate or block. Place the protective cage over the sample basket assembly and allow it to cool to room temperature (approximately 30 min.).
15. Determine and record the mass of the sample and sample basket assembly to the nearest 0.1 g.
16. Calculate the mass of the sample by subtracting the mass of the sample basket assembly from the mass of the sample and sample basket assembly and record to the nearest 0.1 g.
17. Repeat Steps 10 through 13 until the change in measured mass of the sample after ignition does not exceed 0.01 percent of the previous sample mass.
Note 5: An ending mass loss percentage of 0.02 may be used, if allowed by the agency, when aggregate that exhibits an excessive amount of loss during ignition testing is used.
18. Determine and record the mass of the sample and sample basket assembly to the nearest 0.1 g.
19. Calculate the final sample mass by subtracting the mass of the sample basket assembly and sample and sample basket assembly and record to the nearest 0.1 g. Designate this mass as M_f .
20. Calculate the asphalt binder content of the sample.

Calculations

Calculate the asphalt binder content of the sample as follows:

$$P_b = \frac{M_i - M_f}{M_i} \times 100 - MC - C_f$$

where:

P_b = the corrected asphalt binder content as a percent by mass of the asphalt mixture sample

M_f = the final sample mass after ignition, g

M_i = the initial mass of the asphalt mixture sample before ignition, g

MC = moisture content of the companion asphalt mixture sample, percent, as determined by the FOP for AASHTO T 329 (if the specimen was oven-dried before initiating the procedure, MC = 0).

C_f = correction factor as a percent by mass of the asphalt mixture sample

Example

Correction Factor	= 0.42%
Moisture Content	= 0.04%
Initial Mass of Sample and Basket	= 5292.7 g
Mass of Basket Assembly	= 2931.5 g
M_i	= 2361.2 g
Total Mass after First ignition + basket	= 5154.4 g
Sample Mass after First ignition	= 2222.9 g
Sample Mass after additional 15 min ignition	= 2222.7 g

$$\%change = \frac{2222.9 \text{ g} - 2222.7 \text{ g}}{2222.9 \text{ g}} \times 100 = 0.009\%$$

%change is not greater than 0.01 percent, so M_f = 2222.7 g

$$P_b = \frac{2361.2 \text{ g} - 2222.7 \text{ g}}{2361.2 \text{ g}} \times 100 - 0.42\% - 0.04\% = 5.41\%$$

$$P_b = 5.41\%$$

Gradation

1. Empty contents of the basket(s) into a container, being careful to capture all material. Use a small wire brush to ensure all residual fines are removed from the baskets.

Note 7: Particle masks are a recommended safety precaution.

2. Perform the gradation analysis in accordance with the FOP for AASHTO T 30.

Report

- On forms approved by the agency
- Sample ID
- Method of test (A or B)
- Corrected asphalt binder content, P_b , to the nearest 0.01 percent or per agency standard
- Correction factor, C_f , to the nearest 0.01 percent
- Temperature compensation factor (Method A only)
- Total percent loss
- Sample mass
- Moisture content to the nearest 0.01%
- Test temperature

Attach the original printed ticket with all intermediate values (continuous tape) to the report for furnaces with internal balances.

ANNEX – CORRECTION FACTORS

ASPHALT BINDER AND AGGREGATE

(Mandatory Information)

Asphalt binder content results may be affected by the type of aggregate in the mixture and by the ignition furnace. Asphalt binder and aggregate correction factors must, therefore, be established by testing a set of correction specimens for each Job Mix Formula (JMF) mix design. Each ignition furnace will have its own unique correction factor determined in the location where testing will be performed.

This procedure must be performed before any acceptance testing is completed, and repeated each time there is a change in the mix ingredients or design. Any changes greater than 5 percent in stockpiled aggregate proportions should require a new correction factor.

All correction samples will be prepared by a central / regional laboratory unless otherwise directed.

Asphalt binder correction factor: A correction factor must be established by testing a set of correction specimens for each Job Mix Formula (JMF). Certain aggregate types may result in unusually high correction factors (> 1.00 percent). Such mixes should be corrected and tested at a lower temperature as described below.

Aggregate correction factor: Due to potential aggregate breakdown during the ignition process, a correction factor will need to be determined for the following conditions:

- a. Aggregates that have a proven history of excessive breakdown
- b. Aggregate from an unknown source.

This correction factor will be used to adjust the acceptance gradation test results obtained according to the FOP for AASHTO T 30.

Procedure

1. Obtain samples of aggregate in accordance with the FOP for AASHTO R 90.
2. Obtain samples of asphalt binder in accordance with the FOP for AASHTO R 66.
Note 8: Include other additives that may be required by the JMF.
3. Prepare an initial, or “butter,” mix at the design asphalt binder content. Mix and discard the butter mix before mixing any of the correction specimens to ensure accurate asphalt content.
4. Prepare two correction specimens at the JMF design asphalt binder content. Aggregate used for correction specimens shall be sampled from material designated for use on the project. An agency approved method will be used to combine aggregate. An additional “blank” specimen shall be batched and tested for aggregate gradation in accordance with the FOP for AASHTO T 30. The gradation from the “blank” shall fall within the agency specified mix design tolerances.
5. Place the freshly mixed specimens directly into the sample basket assembly. If mixed specimens are allowed to cool before placement in the sample basket assembly, the

specimens must be dried to constant mass according to the FOP for AASHTO T 329. Do not preheat the sample basket assembly.

6. Test the specimens in accordance with Method A or Method B of the procedure.
7. Once both correction specimens have been burned, determine the asphalt binder content for each specimen by calculation or from the printed ignition furnace tickets, if available.
8. If the difference between the asphalt binder contents of the two specimens exceeds 0.15 percent, repeat with two more specimens and, from the four results, discard the high and low result. Determine the correction factor from the two original or remaining results, as appropriate. Calculate the difference between the actual and measured asphalt binder contents for each specimen to 0.01 percent. The asphalt binder correction factor, C_f , is the average of the differences expressed as a percent by mass of asphalt mixture.
9. If the asphalt binder correction factor exceeds 1.00 percent, the test temperature must be lowered to $482 \pm 5^\circ\text{C}$ ($900 \pm 9^\circ\text{F}$) and new samples must be burned. If the correction factor is the same or higher at the lower temperature, it is permissible to use the higher temperature. The temperature for determining the asphalt binder content of asphalt mixture samples by this procedure shall be the same temperature determined for the correction samples.
10. For the direct IR irradiation-type burn furnaces, the **default** burn profile should be used for most materials. The operator may select burn-profile Option 1 or Option 2 to optimize the burn cycle. The burn profile for testing asphalt mixture samples shall be the same burn profile selected for correction samples.
 - Option 1** is designed for aggregate that requires a large asphalt binder correction factor (greater than 1.00 percent) – typically very soft aggregate (such as dolomite).
 - Option 2** is designed for samples that may not burn completely using the **default** burn profile.
11. Perform a gradation analysis on the residual aggregate in accordance with the FOP for AASHTO T 30, if required. The results will be utilized in developing an “Aggregate Correction Factor” and should be calculated and reported to 0.1 percent.
12. From the gradation results subtract the percent passing for each sieve, for each sample, from the percent passing each sieve of the “Blank” specimen gradation results from Step 4.
13. Determine the average difference of the two values. If the difference for any single sieve exceeds the allowable difference of that sieve as listed in Table 2, then aggregate gradation correction factors (equal to the resultant average differences) for all sieves shall be applied to all acceptance gradation test results determined by the FOP for AASHTO T 30. If the 75 μm (No. 200) is the only sieve outside the limits in Table 2, apply the aggregate correction factor to only the 75 μm (No. 200) sieve.

Table 2
Permitted Sieving Difference

Sieve	Allowable Difference
Sizes larger than or equal to 2.36 mm (No.8)	± 5.0%
Sizes larger than to 75 µm (No.200) and smaller than 2.36 mm (No.8)	± 3.0%
Sizes 75 µm (No.200) and smaller	± 0.5%

Examples:

Sieve Size mm (in.)	Correction Factor Blank Sample % Passing	Correction Factor Sample #1 % Passing	Correction Factor Sample #2 % Passing	Difference 1 / 2	Avg. Diff.	Sieves to adjust
19.0 (3/4)	100	100	100	0/0	0.0	
12.5 (1/2)	86.3	87.4	86.4	-1.1/-0.1	-0.6	
9.5 (3/8)	77.4	76.5	78.8	+0.9/-1.4	-0.3	
4.75 (No. 4)	51.5	53.6	55.9	-2.1/-4.4	-3.3	
2.36 (No. 8)	34.7	36.1	37.2	-1.4/-2.5	-2.0	
01.18 (No. 16)	23.3	25.0	23.9	-1.7/-0.6	-1.2	
0.600 (No. 30)	16.4	19.2	18.1	-2.8/-1.7	-2.3	
0.300 (No. 50)	12.0	11.1	12.7	+0.9/-0.7	+0.1	
0.150 (No. 100)	8.1	9.9	6.3	-1.8/+1.8	0.0	
75 µm (No. 200)	5.5	5.9	6.2	-0.4/-0.7	-0.6	- 0.6

In this example, all gradation test results performed on the residual aggregate (FOP for AASHTO T 30) would have an aggregate correction factor applied to the percent passing the 75 µm (No. 200) sieve. The correction factor must be applied because the average difference on the 75 µm (No. 200) sieve is outside the tolerance from Table 2.

In the following example, aggregate correction factors would be applied to each sieve because the average difference on the 4.75 mm (No. 4) is outside the tolerance from Table 2.

Sieve Size mm (in.)	Correction Factor Blank Sample % Passing	Correction Factor Sample #1 % Passing	Correction Factor Sample #2 % Passing	Difference 1 / 2	Avg. Diff.	Sieves to adjust
19.0 (3/4)	100	100	100	0/0	0.0	0.0
12.5 (1/2)	86.3	87.4	86.4	-1.1/-0.1	-0.6	-0.6
9.5 (3/8)	77.4	76.5	78.8	+0.9/-1.4	-0.3	-0.3
4.75 (No. 4)	51.5	55.6	57.9	-4.1/-6.4	-5.3	-5.3
2.36 (No. 8)	34.7	36.1	37.2	-1.4/-2.5	-2.0	-2.0
01.18 (No. 16)	23.3	25.0	23.9	-1.7/-0.6	-1.2	-1.2
0.600 (No. 30)	16.4	19.2	18.1	-2.8/-1.7	-2.3	-2.3
0.300 (No. 50)	12.0	11.1	12.7	+0.9/-0.7	+0.1	+0.1
0.150 (No. 100)	8.1	9.9	6.3	-1.8/+1.8	0.0	0.0
75 μm (No. 200)	5.5	5.9	6.2	-0.4/-0.7	-0.6	-0.6

PERFORMANCE EXAM CHECKLIST**DETERMINING THE ASPHALT BINDER CONTENT OF ASPHALT MIXTURES BY
THE IGNITION METHOD
FOP FOR AASHTO T 308**

Participant Name _____ Exam Date _____

Record the symbols "P" for passing or "F" for failing on each step of the checklist.

Procedure Element	Trial 1	Trial 2
1. Oven at correct temperature $538 \pm 5^{\circ}\text{C}$ ($1000 \pm 9^{\circ}\text{F}$) or correction factor temperature?	_____	_____
Or: for IR ovens, correct burn profile applied?	_____	_____
2. Sample reduced to correct size?	_____	_____
3. Asphalt mixture sample or companion moisture sample taken and dried per FOP for AASHTO T 329?	_____	_____
4. Mass of sample basket assembly recorded to 0.1 g?	_____	_____
5. With pan below basket(s) sample evenly distributed in basket(s)?	_____	_____
6. Mass of sample basket and sample recorded to 0.1 g?	_____	_____
7. Sample mass conforms to the required mass?	_____	_____
8. Method A		
a. Initial mass entered into furnace controller?	_____	_____
b. Internal scale reading zero?	_____	_____
c. Sample correctly placed into furnace?	_____	_____
d. Test continued until stable indicator signals?	_____	_____
e. Uncorrected asphalt binder content obtained on printed ticket?	_____	_____
f. Sample cooled to room temperature?	_____	_____
g. Sample mass determined to nearest 0.1 g.?	_____	_____

OVER

ASPHALT

WAQTC

FOP AASHTO T 308 (22)

Procedure Element

Trial 1 Trial 2

9. Method B

- a. Sample correctly placed into furnace? _____
- b. Sample burned for 45 min or time determined by correction process? _____
- c. Sample cooled to room temperature? _____
- d. Sample burned to constant mass? _____
- e. Sample cooled to room temperature? _____
- f. Sample mass determined to nearest 0.1 g? _____
- g. Uncorrected asphalt binder content calculated correctly and recorded? _____

10. Asphalt binder content corrected for Correction Factor if needed? _____

11. Asphalt binder content corrected for moisture per the FOP for AASHTO T 329 if needed? _____

12. Corrected asphalt binder content recorded? _____

13. Contents of the basket(s) carefully emptied into a pan? _____

Comments: First attempt: Pass _____ Fail _____ Second attempt: Pass _____ Fail _____

Examiner Signature _____ **WAQTC #:** _____

TEMPERATURE OF FRESHLY MIXED PORTLAND CEMENT CONCRETE FOP FOR AASHTO T 309

Scope

This procedure covers the determination of the temperature of freshly mixed Portland Cement Concrete in accordance with AASHTO T 309-22.

Warning—Fresh Hydraulic cementitious mixtures are caustic and may cause chemical burns to skin and tissue upon prolonged exposure.

Apparatus

- **Container:** Made of non-absorptive material and large enough to cover the sensor with concrete at least 75 mm (3 in.) in all directions; concrete cover must also be at least three times the nominal maximum size of the coarse aggregate.
- **Thermometer:** Capable of measuring the temperature of the concrete throughout the temperature range likely to be encountered, at least -18 to 50°C (0 to 120°F), and readable to $\pm 0.5^{\circ}\text{C}$ ($\pm 1^{\circ}\text{F}$) or smaller.

Note 1: Thermometer types suitable for use include ASTM E1 mercury thermometer or ASTM E2251 Low Hazard Precision Liquid-in-glass thermometer; ASTM E2877 digital metal stem thermometer; or thermocouple thermometer ASTM E230, Type T Special or IEC 60584 Type T, Class 1.

Standardization of Thermometer

Each thermometer shall be verified for accuracy annually and whenever there is a question of accuracy. Standardization shall be performed by comparing readings on the thermometer with another calibrated thermometer at two temperatures at least 15°C or 27°F apart.

Sample Locations and Times

The temperature of freshly mixed concrete may be measured in the transporting equipment, in forms, or in sample containers, provided the sensor of the thermometer has at least 75 mm (3 in.) of concrete cover in all direction around it.

Complete the temperature measurement of the freshly mixed concrete within 5 minutes of obtaining the sample.

CONCRETE

WAQTC

FOP AASHTO T 309 (22)

Procedure

1. Dampen the sample container.
2. Obtain the sample in accordance with the FOP for WAQTC TM 2.
3. Place sensor of the thermometer in the freshly mixed concrete so that it has at least 75 mm (3 in.) of concrete cover in all directions around it.
4. Gently press the concrete in around the sensor of the thermometer at the surface of the concrete so that air cannot reach the sensor.
5. Leave the sensor of the thermometer in the freshly mixed concrete for a minimum of two minutes, or until the temperature reading stabilizes.
6. Complete the temperature measurement of the freshly mixed concrete within 5 minutes of obtaining the sample.
7. Read and record the temperature to the nearest 0.5°C (1°F).

Report

- Results on forms approved by the agency
- Sample ID
- Measured temperature of the freshly mixed concrete to the nearest 0.5°C (1°F)

CONCRETE

WAQTC

FOP AASHTO T 309 (09)

PERFORMANCE EXAM CHECKLIST

**TEMPERATURE OF FRESHLY MIXED CONCRETE
FOP FOR AASHTO T 309**

Participant Name _____ Exam Date _____

Record the symbols "P" for passing or "F" for failing on each step of the checklist.

Procedure Element	Trial 1	Trial 2
1. Obtain sample of concrete large enough to provide a minimum of 75 mm (3 in.) of concrete cover around sensor in all directions?	_____	_____
2. Place thermometer in sample with a minimum of 75 mm (3 in.) cover around sensor?	_____	_____
3. Gently press concrete around thermometer?	_____	_____
4. Read temperature after a minimum of 2 minutes or when temperature reading stabilizes?	_____	_____
5. Complete temperature measurement within 5 minutes of obtaining sample?	_____	_____
6. Record temperature to nearest 0.5°C (1°F)?	_____	_____

Comments: First attempt: Pass____Fail_____ Second attempt: Pass____Fail_____

Examiner Signature _____ WAQTC #: _____

This checklist is derived, in part, from copyrighted material printed in ACI CP-1, published by the American Concrete Institute.

CONCRETE

WAQTC

FOP AASHTO T 309 (09)

WSDOT Errata to FOP for AASHTO T 310

In-Place Density and Moisture Content of Soil and Soil-Aggregate by Nuclear Methods (Shallow Depth)

WAQTC FOP for AASHTO T 310 has been adopted by WSDOT with the following changes:

Procedure

Replace step 1 with below:

1. WSDOT requires test location selected per WSDOT SOP 615.
6. Place the gauge on the prepared surface so the source rod can enter the hole without disturbing loose material.

Include note below:

Note: For alignment purposes, the user may expose the source rod for a maximum of ten seconds.

10. Perform one of the following methods, per agency requirements:
 - a. Method A Single Direction: - *Method not recognized by WSDOT.*
11. *Step not required by WSDOT.*
12. *Step not required by WSDOT. Replace step 13 with below:*
13. Determine the dry density by one of the following:
 - a. If the moisture content is determined by nuclear methods, use gauge dry density readings directly.
 - b. If moisture content is determined by FOP for AASHTO T 255/T 265, compute dry density by dividing the wet density from the nuclear gauge by $1 + \text{moisture content}$ expressed as a decimal.

Percent Compaction

Determined using WSDOT SOP 615.

IN-PLACE DENSITY AND MOISTURE CONTENT OF SOIL AND SOIL-AGGREGATE BY NUCLEAR METHODS (SHALLOW DEPTH) FOP FOR AASHTO T 310

Scope

This procedure covers the determination of density, moisture content, and relative compaction of soil, aggregate, and soil-aggregate mixes in accordance with AASHTO T 310-22. This procedure provides a rapid, nondestructive technique for determining the in-place wet density and moisture content of soil, aggregate, and soil-aggregate mixes. This field operating procedure is derived from AASHTO T 310. The nuclear moisture-density gauge is used in the direct transmission mode.

Apparatus

- Nuclear density gauge with the factory matched standard reference block.
- Drive pin, guide/scrapper plate, and hammer for testing in direct transmission mode.
- Transport case for properly shipping and housing the gauge and tools.
- Instruction manual for the specific make and model of gauge.
- Radioactive materials information and calibration packet containing:
 - Daily Standard Count Log.
 - Factory and Laboratory Calibration Data Sheet.
 - Leak Test Certificate.
 - Shippers Declaration for Dangerous Goods.
 - Procedure Memo for Storing, Transporting and Handling Nuclear Testing Equipment.
 - Other radioactive materials documentation as required by local regulatory requirements.
- Sealable containers and utensils for moisture content determinations.

Radiation Safety

This method does not purport to address all of the safety problems associated with its use. This test method involves potentially hazardous materials. The gauge utilizes radioactive materials that may be hazardous to the health of the user unless proper precautions are taken. Users of this gauge must become familiar with the applicable safety procedures and governmental regulations. All operators will be trained in radiation safety prior to operating nuclear density gauges. Some agencies require the use of personal monitoring devices such as a thermoluminescent dosimeter or film badge. Effective instructions together with routine safety procedures such as source leak tests, recording and evaluation of personal monitoring device data, etc., are a recommended part of the operation and storage of this gauge.

Calibration

Calibrate the nuclear gauge as required by the agency. This calibration may be performed by the agency using manufacturer's recommended procedures or by other facilities approved by the agency. Verify or re-establish calibration curves, tables, or equivalent coefficients every 12 months.

Standardization

1. Turn the gauge on and allow it to stabilize (approximately 10 to 20 minutes) prior to standardization. Leave the power on during the day's testing.
2. Standardize the nuclear gauge at the construction site at the start of each day's work and as often as deemed necessary by the operator or agency. Daily variations in standard count shall not exceed the daily variations established by the manufacturer of the gauge. If the daily variations are exceeded after repeating the standardization procedure, the gauge should be repaired and/or recalibrated.
3. Record the standard count for both density and moisture in the Daily Standard Count Log. The exact procedure for standard count is listed in the manufacturer's Operator's Manual.

Note 1: New standard counts may be necessary more than once a day. See agency requirements.

Overview

There are two methods for determining in-place density of soil / soil aggregate mixtures. See agency requirements for method selection.

- Method A Single Direction
- Method B Two Direction

Procedure

1. Select a test location(s) randomly and in accordance with agency requirements. Test sites should be relatively smooth and flat and meet the following conditions:
 - a. At least 10 m (30 ft) away from other sources of radioactivity
 - b. At least 3 m (10 ft) away from large objects
 - c. The test site should be at least 150 mm (6 in.) away from any vertical projection.
 - d. Correct for trench wall effect according to manufacturer's correction procedures if the test site is closer than 600 mm (24 in.) to vertical projection. See Note 2.

Note 2: To perform moisture and density tests in a trench or against a large solid object, it is necessary to perform a trench offset correction to adjust the gauge, or it may read a falsely high moisture content. Moisture present in the walls can thermalize neutrons which return to the gauge and are read as moisture by the detector in the gauge.

2. Remove all loose and disturbed material and remove additional material as necessary to expose the top of the material to be tested.
3. Prepare a flat area sufficient in size to accommodate the gauge. Plane the area to a smooth condition so as to obtain maximum contact between the gauge and the

material being tested. For Method B, the flat area must be sufficient to permit rotating the gauge 90 or 180 degrees about the source rod.

4. Fill in surface voids beneath the gauge with fines of the material being tested passing the 4.75 mm (No. 4) sieve or finer. Smooth the surface with the guide plate or other suitable tool. The depth of the filler should not exceed approximately 3 mm (1/8 in.).
5. Make a hole perpendicular to the prepared surface using the guide plate and drive pin. The hole shall be at least 50 mm (2 in.) deeper than the desired source rod depth and shall be aligned such that insertion of the source rod will not cause the gauge to tilt from the plane of the prepared area. Remove the drive pin by pulling straight up and twisting the extraction tool.
6. Place the gauge on the prepared surface so the source rod can enter the hole without disturbing loose material.
7. Lower the source rod into the hole to the desired test depth using the handle and trigger mechanism.
8. Seat the gauge firmly by partially rotating it back and forth about the source rod. Ensure the gauge is seated flush against the surface by pressing down on the gauge corners and making sure that the gauge does not rock.
9. Pull gently on the gauge to bring the side of the source rod nearest to the scaler / detector firmly against the side of the hole.
10. Perform one of the following methods, per agency requirements:
 - a. Method A Single Direction: Take a test consisting of the average of two, one-minute readings, and record both density and moisture data. The two wet density readings should be within 32 kg/m^3 (2.0 lb/ft^3) of each other. The average of the two wet densities and moisture contents will be used to compute dry density.
 - b. Method B Two Direction: Take a one-minute reading and record both density and moisture data. Rotate the gauge 90 or 180 degrees, pivoting it around the source rod. Reseat the gauge by pulling gently on the gauge to bring the side of the source rod nearest to the scaler/detector firmly against the side of the hole and take a one-minute reading. (In trench locations, rotate the gauge 180 degrees for the second test.) Some agencies require multiple one-minute readings in both directions. Analyze the density and moisture data. A valid test consists of wet density readings in both gauge positions that are within 50 kg/m^3 (3.0 lb/ft^3). If the tests do not agree within this limit, move to a new location. The average of the wet density and moisture contents will be used to compute dry density.
11. If required by the agency, obtain a representative sample of the material, 4 kg (9 lb) minimum, from directly beneath the gauge full depth of material tested. This sample will be used to verify moisture content and / or identify the correct density standard. Immediately seal the material to prevent loss of moisture.

The material tested by direct transmission can be approximated by a cylinder of soil approximately 300 mm (12 in.) in diameter directly beneath the centerline of the

radioactive source and detector. The height of the cylinder will be approximately the depth of measurement. When organic material or large aggregate is removed during this operation, disregard the test information, and move to a new test site.

12. To verify the moisture content from the nuclear gauge, determine the moisture content with a representative portion of the material using the FOP for AASHTO T 255/T 265 or other agency approved methods. If the moisture content from the nuclear gauge is within ± 1 percent, the nuclear gauge readings can be accepted. Moisture content verification is gauge and material specific. Retain the remainder of the sample at its original moisture content for a one-point compaction test under the FOP for AASHTO T 272, or for gradation, if required.

Note 2: Example: A gauge reading of 16.8 percent moisture and an oven dry of 17.7 percent are within the ± 1 percent requirement. Moisture correlation curves will be developed according to agency guidelines. These curves should be reviewed and possibly redeveloped every 90 days.

13. Determine the dry density by one of the following.
 - a. From nuclear gauge readings, compute by subtracting the mass (weight) of the water (kg/m^3 or lb/ft^3) from the wet density (kg/m^3 or lb/ft^3) or compute using the percent moisture by dividing wet density from the nuclear gauge by 1 plus the moisture content expressed as a decimal.
 - b. When verification is required and the nuclear gauge readings cannot be accepted, the moisture content is determined by the FOP for AASHTO T 255/T 265 or other agency approved methods. Compute dry density by dividing wet density from the nuclear gauge by 1 plus the moisture content expressed as a decimal.

Percent Compaction

- Percent compaction is determined by comparing the in-place dry density as determined by this procedure to the appropriate agency density standard. For soil or soil-aggregate mixes, these are moisture-density curves developed using the FOP for AASHTO T 99/T 180. When using maximum dry densities from the FOP for AASHTO T 99/T 180 or FOP for AASHTO T 272, it may be necessary to use the Annex in the FOP for T 99/T 180 to determine corrected maximum dry density and optimum moisture content.

For coarse granular materials, the density standard may be density-gradation curves developed using a vibratory method such as AKDOT&PF's ATM 212, ITD's T 74, WAQTC TM 15, or WFLHD's Humphres.

See appropriate agency policies for use of density standards.

IN-PLACE DENSITY

WAQTC

FOP AASHTO T 310 (22)

Calculation**Calculate the dry density as follows:**

$$\rho_d = \left(\frac{\rho_w}{w + 100} \right) \times 100 \quad \text{or} \quad \rho_d = \frac{\rho_w}{\frac{w}{100} + 1}$$

Where:

 ρ_d = Dry density, kg/m³ (lb/ft³) ρ_w = Wet density, kg/m³ (lb/ft³)

w = Moisture content from the FOP's for AASHTO T 255 / T 265, as a percentage

Calculate percent compaction as follows:

$$\% \text{ Compaction} = \frac{\rho_d}{\text{Agency density standard}} \times 100$$

Where:

 ρ_d = Dry density, kg/m³ (lb/ft³)

Agency density standard = Corrected maximum dry density from the FOP from T 99/T 180 Annex

Example:Wet density readings from gauge: 1948 kg/m³ (121.6 lb/ft³)1977 kg/m³ (123.4 lb/ft³)Avg: 1963 kg/m³ (122.5 lb/ft³)**Moisture readings from gauge: 14.2% and 15.4% = Avg 14.8%**

Moisture content from the FOP's for AASHTO T 255/ T 265: 15.9%

Moisture content is greater than 1 percent different so the gauge moisture cannot be used.

Calculate the dry density as follows:

$$\rho_d = \left(\frac{1963 \text{ kg/m}^3 \text{ or } 122.5 \text{ lb/ft}^3}{15.9 + 100} \right) \times 100 \text{ or } \rho_d = \frac{1963 \text{ kg/m}^3 \text{ or } 122.5 \text{ lb/ft}^3}{\frac{15.9}{100} + 1}$$

$$= 1694 \text{ kg/m}^3 \text{ or } 105.7 \text{ lb/ft}^3$$

Given:

$$\rho_w = 1963 \text{ kg/m}^3 \text{ or } 122.5 \text{ lb/ft}^3$$

$$w = 15.9\%$$

Calculate percent compaction as follows:

$$\% \text{ Compaction} = \frac{105.7 \text{ lb/ft}^3}{111.3 \text{ lb/ft}^3} \times 100 = 95\%$$

Given:

$$\text{Agency density standard} = 111.3 \text{ lb/ft}^3$$

Report

- On forms approved by the agency
- Sample ID
- Location of test, elevation of surface, and thickness of layer tested
- Visual description of material tested
- Make, model and serial number of the nuclear moisture-density gauge
- Wet density to the nearest 0.1 lb/ft³
- Moisture content as a percent, by mass, of dry soil mass to the nearest 0.1 percent
- Dry density to the nearest 0.1 lb/ft³
- Density standard to the nearest 0.1 lb/ft³
- Percent compaction the nearest 1 percent
- Name and signature of operator

IN-PLACE DENSITY

WAQTC

FOP AASHTO T 310 (20)

PERFORMANCE EXAM CHECKLIST**IN-PLACE DENSITY AND MOISTURE CONTENT OF SOIL AND SOIL-
AGGREGATE BY NUCLEAR METHODS (SHALLOW DEPTH)
FOP FOR AASHTO T 310**

Participant Name _____ Exam Date _____

Record the symbols "P" for passing or "F" for failing on each step of the checklist.

Procedure Element	Trial 1	Trial 2
1. Gauge turned on 10 to 20 minutes before use?	_____	_____
2. Calibration verified?	_____	_____
3. Standard count taken and recorded in accordance with manufacturer's instructions?	_____	_____
4. Test location selected appropriately 10 m (30 ft.) from other radioactive sources, 3 m (10 ft.) from large objects, 150 mm (6 in.) away from vertical projections?	_____	_____
5. Loose, disturbed material removed?	_____	_____
6. Flat, smooth area prepared?	_____	_____
7. Surface voids filled with native fines (-No. 4) to 3 mm (1/8 in.) maximum thickness?	_____	_____
8. Hole driven 50 mm (2 in.) deeper than source rod depth?	_____	_____
9. Gauge placed and source rod lowered without disturbing loose material?	_____	_____
10. Method A:		
a. Gauge firmly seated, and gently pulled back so that the source rod is against the side of the hole toward the scaler / detectors?	_____	_____
b. Two, one-minute reading taken; wet density within 32 kg/m ³ (2.0 lb/ft ³)?	_____	_____
c. Density and moisture data averaged?	_____	_____
11. Method B:		
a. Gauge firmly seated, and gently pulled back so that the source rod is against the side of the hole toward the scaler / detectors?	_____	_____
b. A minimum of a one-minute reading taken; density and moisture data recorded?	_____	_____
c. Gauge turned 90° or 180° (180° in trench)?	_____	_____

OVER

Procedure Element	Trial 1	Trial 2
d. Gauge firmly seated, and gently pulled back so that the source rod is against the side of the hole toward the scaler / detectors?	_____	_____
e. A minimum of a one-minute reading taken; density and moisture data recorded?	_____	_____
f. Wet densities within 50 kg/m ³ (3.0 lb/ft ³)?	_____	_____
g. Density and moisture data averaged?	_____	_____
12. Representative sample (4 kg or 9 lb) obtained from test location?	_____	_____
13. Sample sealed immediately to prevent moisture loss?	_____	_____
14. Moisture content correctly determined using other means than the nuclear density gauge reading?	_____	_____
15. Dry Density calculated using proper moisture content?	_____	_____
16. Percent compaction calculated correctly?	_____	_____

Comments: First attempt: Pass _____ Fail _____ Second attempt: Pass _____ Fail _____

Examiner Signature _____ WAQTC #: _____

WSDOT Errata to FOP for AASHTO T 312

Preparing and Determining the Density of Asphalt Mixture Specimens by Means of the Superpave Gyrotory Compactor

WAQTC FOP for AASHTO T 312 has been adopted by WSDOT with the following changes:

Equipment Preparation

Include bullet below:

- Pre-heat molds and plates in the oven set no more than 25° F above the compaction temperature shown on the mix design report.

Sample Preparation

Plant Produced Asphalt Mixtures

Replace step 3 with below:

3. Place in the oven until the material is 5° F above the compaction temperature shown on the mix design report.

Compaction Procedure

Replace step 3 with below:

3. Remove the pan of Asphalt Mixture from the oven and in one motion invert the pan onto the construction paper, vinyl mat, etc. Quickly remove any material that remains in the pan and include it with the Asphalt Mixture sample to be compacted. Grasp opposing edges of the paper and roll them together to form the Asphalt Mixture into a cylindrical shape. Insert one end of the paper roll into the bottom of the compaction mold and remove the paper as the Asphalt Mixture slides into the mold. This process needs to be accomplished in approximately 60 seconds. Place the mixture into the mold in one lift. Care should be taken to avoid segregation in the mold.

PREPARING AND DETERMINING THE DENSITY OF ASPHALT MIXTURE SPECIMENS BY MEANS OF THE SUPERPAVE GYRATORY COMPACTOR FOP FOR AASHTO T 312

Scope

This procedure covers preparing specimens, using samples of plant produced asphalt mixtures, for determining the mechanical and volumetric properties of asphalt mixtures in accordance with AASHTO T 312-22.

Apparatus

- Superpave Gyratory Compactor (SGC) meeting the requirements of AASHTO T 312
- Molds meeting the requirements of AASHTO T 312
- Chute, mold funnel or both (Optional)
- Scale meeting the requirements of AASHTO M 231 Class G 5
- Oven, thermostatically controlled, capable of maintaining set temperature within $\pm 3^{\circ}\text{C}$ ($\pm 5^{\circ}\text{F}$)
- Thermometers with a temperature range of at least 10 to 230°C (50 - 450°F) and accurate to $\pm 1^{\circ}\text{C}$ ($\pm 2^{\circ}\text{F}$)

Note 1: Non-Contact thermometers are not acceptable.

- Miscellaneous pans, spoons, spatulas, hot pads, gloves, paper discs, markers, etc.

Equipment Requirements

The calibration shall be performed on the SGC per the Manufacturer's instructions. See agency requirements for the calibration frequency.

The mold and base plate dimensions shall be checked every twelve months or 80 hours of operation to determine that they are within the tolerances listed in AASHTO T 312.

Equipment Preparation

Prepare the equipment in accordance with manufacturer's recommendations. At a minimum preparation includes:

- Warm-up gyratory compactor
- Verify machine settings
 - Internal Angle: $1.16 \pm 0.02^{\circ}$
 - Ram Pressure: $600 \text{ kPa} \pm 18 \text{ kPa}$

- Number of gyrations

Note 2: The number of gyrations (N_{des}) is obtained from the Job Mix Formula (JMF).

- Lubricate bearing surfaces
- Prepare recording device as required
- Pre-heat molds and plates at the compaction temperature range (minimum of 30 min.) or before reuse reheat (minimum of 5 min.)

Note 3: The use of multiple molds will speed up the compaction process.

- Pre-heat chute, mold funnel, spatulas, and other apparatus (not to exceed the maximum compaction temperature)

Sample Preparation

Laboratory Prepared Asphalt Mixtures

This is a sample produced during the Mix Design process using aggregate and binder that is combined in the laboratory. When designing asphalt mixtures using the gyratory compactor, refer to AASHTO T 312 and AASHTO R 35.

Plant Produced Asphalt Mixtures

- Determine initial sample size, number of gyrations (N_{des}), and compaction temperature range from the Job Mix Formula (JMF).
- Obtain the sample in accordance with the FOP for AASHTO R 97.
- Reduce the sample in accordance with the FOP for AASHTO R 47.
- The sample size should be such that it results in a compacted specimen that is 115 ± 5 mm at the desired number of gyrations.

Note 4: Replicate specimens are generally prepared. Refer to agency requirements.

If the material is not in the compaction temperature range:

1. Place the appropriate sample mass into a container.
2. Spread to a depth of 1 to 2 in. for even heating of mixture.
3. Place in the oven until the material is within the compaction temperature range.

Note 5: The material properties may be altered when the times of delivery of the test sample and the placement of the material on the roadway are different.

Compaction Procedure

Follow the manufacturer's recommended loading procedure. This may require the steps below to be performed in a different order. Steps 1 through 8 must be performed before the sample and mold cools below minimum compaction temperature.

1. Remove pre-heated mold and plate(s) from the oven (verify mold and plate(s) has been cleaned if previously used).
2. Place the base plate and paper disc in bottom of mold.
3. Place the mix into the mold in a single lift (care should be taken to avoid segregation or loss of material).
4. Level the mix in the mold.
5. Place a paper disc and the heated upper plate (if required) on top of the leveled sample.
6. Load the mold into the compactor, check settings.
7. Start the compaction process.
 - a. Check the pressure (600 ± 18 kPa).
 - b. Check the angle ($1.16 \pm 0.02^\circ$).
8. Extrude the specimen from the mold; a brief cooling period may be necessary before fully extruding some specimens to ensure the specimens are not damaged.

Note 6: Clean molds after each use.

9. Upon completion of the compaction process, record the number of gyrations and specimen height.

Note 7: If the specimen is not 115 ± 5 mm, follow agency requirements.

10. Carefully remove the paper discs.
11. Cool the compacted specimen to room temperature.
12. Identify the specimen with chalk or other marker.

Report

- On forms approved by the agency
- Sample ID
- Number of gyrations
- Specimen height to the nearest 0.1 mm

ASPHALT II

WAQTC

FOP AASHTO T 312 (22)

PERFORMANCE EXAM CHECKLIST

PREPARING AND DETERMINING THE DENSITY OF ASPHALT MIXTURE SPECIMENS BY MEANS OF THE SUPERPAVE GYRATORY COMPACTOR FOP FOR AASHTO T 312

Participant Name _____ Exam Date _____

Record the symbols "P" for passing or "F" for failing on each step of the checklist.

Procedure Element	Trial 1	Trial 2
1. Angle, pressure and number of gyrations set?	_____	_____
2. Bearing surfaces, rotating base surface, and rollers lubricated?	_____	_____
3. Representative sample obtained according to the FOP for AASHTO R 97?	_____	_____
4. Sample reduced according to FOP AASHTO R 47?	_____	_____
5. Sample placed in a container and spread to 1 or 2 inches thick for even heating?	_____	_____
6. Asphalt mixture heated to compaction temperature range?	_____	_____
7. Mold, base plate, and upper plate heated to compaction temperature range?	_____	_____
8. Mold, base plate, and upper plate (if required) removed from oven and paper disk placed on bottom of mold?	_____	_____
9. Mix placed into mold in one lift without segregation?	_____	_____
10. Paper disk placed on top of the asphalt mixture?	_____	_____
11. Mold placed into compactor and upper plate clamped into place?	_____	_____
12. Pressure applied at 600 kPa ±18 kPa?	_____	_____
13. Specified number of gyrations applied?	_____	_____
14. Proper angle confirmed from display?	_____	_____
15. Compacted specimen removed from mold, paper disc(s) removed, and allowed to cool to room temperature?	_____	_____
16. Asphalt mixture sample measured to a height of 115 ±5 mm at required gyrations?	_____	_____

Comments: First attempt: Pass_____Fail_____ Second attempt: Pass_____Fail_____

Examiner Signature _____ WAQTC #: _____

ASPHALT II

WAQTC

FOP AASHTO T 312 (20)

MOISTURE CONTENT OF ASPHALT MIXTURES BY OVEN METHOD FOP FOR AASHTO T 329

Scope

This procedure covers the determination of moisture content of asphalt mixtures in accordance with AASHTO T 329-22.

Overview

Moisture content is determined by comparing the wet mass of a sample and the mass of the sample after drying to constant mass. The term constant mass is used to define when a sample is dry.

Constant mass – the state at which a mass does not change more than a given percent, after additional drying for a defined time interval, at a required temperature.

Apparatus

- Balance or scale: 2 kg capacity, readable to 0.1 g and conforming to AASHTO M 231.
- Forced draft, ventilated, or convection oven: Capable of maintaining the temperature surrounding the sample at $163 \pm 14^{\circ}\text{C}$ ($325 \pm 25^{\circ}\text{F}$).
- Sample Container: Clean, dry, not affected by heat and of sufficient size to contain a test sample without danger of spilling.
- Thermometer or other suitable device with a temperature range of 50 to 200°C (122 to 392°F) and readable to the nearest 2°C (4°F).

Sample

The test sample shall be obtained in accordance with the FOP for AASHTO R 97 and reduced in accordance with the FOP for AASHTO R 47. The size of the test sample shall be a minimum of 1000 g.

Procedure

1. Preheat the oven to the Job Mix Formula (JMF) mixing temperature range. If the mixing temperature is not supplied, a temperature of $163 \pm 14^{\circ}\text{C}$ ($325 \pm 25^{\circ}\text{F}$) is to be used.
2. Determine and record the mass of the sample container, including release media, to the nearest 0.1 g.
Note 1: When using paper or other absorptive material to line the sample container ensure it is dry before determining initial mass of sample container.
3. Place the test sample in the sample container.
4. Determine and record the temperature of the test sample.
5. Determine and record the total mass of the sample container and test sample to the nearest 0.1 g.

6. Calculate the initial, moist mass (M_i) of the test sample by subtracting the mass of the sample container as determined in Step 2 from the total mass of the sample container and the test sample as determined in Step 5.
7. The test sample shall be initially dried for 90 ± 5 minutes, and its mass determined. Then it shall be dried at 30 ± 5 minute intervals until further drying does not alter the mass by more than 0.05 percent.
8. Cool the sample container and test sample to $\pm 9^\circ\text{C}$ ($\pm 15^\circ\text{F}$) of the temperature determined in Step 4.
9. Determine and record the total mass of the sample container and test sample to the nearest 0.1 g.
10. Calculate the final, dry mass (M_f) of the test sample by subtracting the mass of the sample container as determined in Step 2 from the total mass of the sample container and the test sample as determined in Step 9.

Note 2: Moisture content and the number of samples in the oven will affect the rate of drying at any given time. Placing wet samples in the oven with nearly dry samples could affect the drying process.

Calculations

Constant Mass:

Calculate constant mass using the following formula:

$$\% \text{ Change} = \frac{M_p - M_n}{M_p} \times 100$$

Where:

M_p = previous mass measurement

M_n = new mass measurement

Example:

Mass of container: 232.6 g

Mass of container and sample after first drying cycle: 1361.8 g

Mass, M_p , of possibly dry sample: $1361.8 \text{ g} - 232.6 \text{ g} = 1129.2 \text{ g}$

Mass of container and possibly dry sample after second drying cycle: 1360.4 g

Mass, M_n , of possibly dry sample: $1360.4 \text{ g} - 232.6 \text{ g} = 1127.8 \text{ g}$

$$\% \text{ Change} = \frac{1129.2 \text{ g} - 1127.8 \text{ g}}{1129.2 \text{ g}} \times 100 = 0.12\%$$

0.12 percent is not less than 0.05 percent, so continue drying the sample.

Mass of container and possibly dry sample after third drying cycle: 1359.9 g

Mass, M_n , of dry sample: $1359.9 \text{ g} - 232.6 \text{ g} = 1127.3 \text{ g}$

$$\% \text{ Change} = \frac{1127.8 \text{ g} - 1127.3 \text{ g}}{1127.8 \text{ g}} \times 100 = 0.04\%$$

0.04 percent is less than 0.05 percent, so constant mass has been reached.

Moisture Content:

Calculate the moisture content, as a percent, using the following formula.

$$\text{Moisture Content} = \frac{M_i - M_f}{M_f} \times 100$$

Where:

M_i = initial, moist mass

M_f = final, dry mass

ASPHALT

WAQTC

FOP AASHTO T 329 (22)

Example:

$$M_i = 1134.9 \text{ g}$$

$$M_f = 1127.3 \text{ g}$$

$$\text{Moisture Content} = \frac{1134.9 \text{ g} - 1127.3 \text{ g}}{1127.3 \text{ g}} \times 100 = 0.674, \text{ say } 0.67\%$$

Report

- On forms approved by the agency
- Sample ID
- Moisture content to the nearest 0.01 percent

ASPHALT

WAQTC

FOP AASHTO T 329 (09)

PERFORMANCE EXAM CHECKLIST

**MOISTURE CONTENT OF ASPHALT MIXTURES BY OVEN METHOD
FOP FOR AASHTO T 329**

Participant Name _____ Exam Date _____

Record the symbols “P” for passing or “F” for failing on each step of the checklist.

Procedure Element	Trial 1	Trial 2
1. Mass of clean dry container including release media determined to 0.1 g?	_____	_____
2. Representative sample obtained; 1000 g minimum?	_____	_____
3. Initial temperature taken and recorded?	_____	_____
4. Mass of sample determined to 0.1 g?	_____	_____
5. Sample placed in drying oven for 90 ±5 minutes?	_____	_____
6. Sample dried at a temperature not to exceed the JMF mixing temp?	_____	_____
7. Constant mass checked at 30 ±5 minute intervals and reached?	_____	_____
8. Sample and container cooled to ±9°C (15°F) of the initial temperature before final mass determined to 0.1 g?	_____	_____
9. Calculation of moisture content performed correctly to 0.01 percent?	_____	_____

$$Moisture\ Content = \frac{M_i - M_f}{M_f} \times 100$$

Comments: First attempt: Pass _____ Fail _____ Second attempt: Pass _____ Fail _____

Examiner Signature _____ WAQTC #: _____

ASPHALT

WAQTC

FOP AASHTO T 329 (09)

BULK SPECIFIC GRAVITY (G_{mb}) AND DENSITY OF COMPACTED ASPHALT MIXTURES USING AUTOMATIC VACUUM SEALING METHOD FOP FOR AASHTO T 331

Scope

This method covers the determination of bulk specific gravity (G_{mb}) of compacted asphalt mixture specimens in accordance with AASHTO T 331-21.

Overview

This method is used when specimens have open or interconnecting voids or absorb more than 2.0 percent of water by volume, or both, according to the FOP for AASHTO T 166.

Bulk specific gravity (G_{mb}) determined by this method may be lower, and air voids higher, than the results determined according to the FOP for AASHTO T 166. The differences may be more pronounced for coarse and absorptive mixtures. This procedure should be followed during laboratory mix designing if it will be used for control or assurance testing.

Test Specimens

Test specimens may be either laboratory-molded or sampled from asphalt mixture pavement. For specimens it is recommended that the diameter be equal to four times the maximum size of the aggregate and the thickness be at least one and one half times the maximum size of the aggregate.

Terminology

Constant Mass: The state at which a mass does not change more than a given percent, after additional drying for a defined time interval, at a required temperature.

Apparatus

- Bag cutter: knife or scissors
- Balance or scale: 5 kg capacity, readable to 0.1 g, and fitted with a suitable suspension apparatus and holder to permit weighing the specimen while suspended in water, conforming to AASHTO M 231.
- Suspension apparatus: Wire of the smallest practical size and constructed to permit the container to be fully immersed.
- Water bath: For immersing the specimen in water while suspended under the balance or scale and equipped with an overflow outlet for maintaining a constant water level.
- Oven: Capable of maintaining a temperature of $110 \pm 5^{\circ}\text{C}$ ($230 \pm 9^{\circ}\text{F}$) for drying the specimens to a constant mass.
- Thermometer: Having a range of 19 to 27°C (66 to 80°F), graduated in 0.1°C (0.2°F) subdivisions.

- Plastic bags: puncture resistant impermeable plastic bags that will not stick to the specimen and capable of withstanding temperatures up to 70°C (158°F). Between 0.100 mm (0.004 in.) and 0.152 mm (0.006 in.) thick. The bag correction factor (apparent specific gravity) is supplied by the manufacturer.
 - Small bag: less than 35 g with an opening between 235 mm (9.25 in.) and 260 mm (10.25 in.)
 - Large bag: 35 g or more with an opening between 375 mm (14.75 in.) and 394 mm (15.5 in.)

Note 1: The bag correction factor is usually located in the operator's manual. See the manufacturer's recommendations to ensure proper handling of bags.

- Specimen sliding plates: removable level and smooth-sided planar filler plates shall be inserted into the chamber to keep the samples of various heights level with the seal bar while being sealed.
- Specimen support plate: a plate with a cushioning membrane on top large enough to fully support the specimen and can easily slide on top of the smooth-sided plates.
- Vacuum chamber and sealing device: meeting the requirements of AASHTO T 331
- Vacuum gauge: meeting the requirements of AASHTO T 331

Procedure

Recently molded laboratory samples that have not been exposed to moisture do not need drying.

1. Dry the specimen to constant mass, if required.
 - a. Oven method
 - i. Initially dry overnight at $52 \pm 3^\circ\text{C}$ ($125 \pm 5^\circ\text{F}$).
 - ii. Determine and record the mass of the specimen. Designate as M_p .
 - iii. Return the specimen to the oven for at least 2 hours.
 - iv. Determine and record the mass of the specimen. Designate as M_n .
 - v. Determine percent change by subtracting the new mass determination, M_n , from the previous mass determination, M_p , divide by the previous mass determination, M_p , and multiply by 100.
 - vi. Continue drying until there is no more than 0.05 percent change in specimen mass after 2-hour drying intervals (constant mass).
 - vii. Constant mass has been achieved; sample is defined as dry.
 - b. Vacuum dry method according to the FOP for AASHTO R 79.
2. Cool the specimen in air to $25 \pm 5^\circ\text{C}$ ($77 \pm 9^\circ\text{F}$), and determine and record the dry mass to the nearest 0.1 g. Designate this mass as A.

Note 1: 3000 to 6000 g laboratory compacted specimens may be considered room temperature after 2 hr. under a fan. Cooling time may be reduced for smaller specimens.

3. Fill the water bath to overflow level with water at $25 \pm 1^\circ\text{C}$ ($77 \pm 1.8^\circ\text{F}$) and allow the water to stabilize
4. Seal the specimen.
 - a. Use a large bag for 150 mm (6 in.) in by 50 mm (2 in.) or greater specimens. Use a small bag for smaller specimens.
 - b. Set the heat-sealing bar temperature according to manufacturer's directions.
 - c. Inspect the bag for holes and irregularities.
 - d. Determine and record the mass of the bag. Designate as B.
 - e. Adjust filler plates in the vacuum chamber, adding or removing plates as needed.
 - f. Place specimen support plate on top of filler plates.
 - g. Place the bag on top of the specimen support plate in the vacuum chamber.
 - h. Insert the specimen into the bag with the smoothest plane of the specimen on the bottom.

Note 2: Inserting the specimen into the bag may be done inside the chamber while holding the bag open with one hand over the sliding plate and gently inserting the specimen with the other hand. There should be about 25 mm (1 in.) of slack between the presealed bag end and the specimen.

- i. Grab the unsealed end of the bag on each side.
- j. Gently pull and center the bag over the seal bar, overlapping at least 25 mm (1 in.). Ensure that there are no wrinkles in the bag along the seal bar before closing the lid.
- k. Close the lid and engage the lid-retaining latch.

Note 3: The vacuum pump light will illuminate "red," and the vacuum gauge on the exterior of the chamber will become active, or a digital reading will show the vacuum state. It is normal for the bag to expand or "puff up" during this process.

- l. Once sealed, the 'de-vac' valve will open, and air will enter the chamber, causing atmospheric pressure to collapse the bag around the specimen.
 - m. Disengage the lid-retaining latch, and carefully remove the sealed specimen from the chamber. Gently pull on the bag where it appears loose. Loose areas indicate a poor seal and the process must then be restarted at Step 4 with a new bag and a new initial mass.
5. Zero or tare the balance with the immersion apparatus attached, ensuring that the device is not touching the sides or the bottom of the water bath.
 6. Fully submerge the specimen and bag shaking to remove the air bubbles. Ensure no air is trapped under the bag or in the bag creases. Place the specimen on its side in the suspension apparatus.
 7. Allow water level and scale to stabilize.
 8. Determine and record the submerged weight to the nearest 0.1 g. Designate this submerged weight as E.

Note 4: Complete Steps 4 through 7 in 1 min. or less to reduce potential for bag leaks.

9. Cut the bag open.
10. Remove the specimen from the bag.
11. Determine the mass of the specimen. Designate as C.
12. Compare this mass, C, with initial dry mass determined in Step 2, A.

If more than 0.08 percent is lost or more than 0.04 percent is gained, return to Step 1.

13. Calculate G_{mb} and record to three decimal places.

Calculations

Calculate constant mass using the following formula:

$$\%Change = \frac{M_p - M_n}{M_p} \times 100$$

Where:

M_p = previous mass measurement, g

M_n = new mass measurement, g

Calculate the bulk specific gravity (G_{mb}) using the following formula:

$$G_{mb} = \frac{A}{C + B - E - \left(\frac{B}{F}\right)}$$

Where:

G_{mb} = bulk specific gravity

A = mass of dry specimen in air, g

B = mass of the bag in air, g

C = final mass of the specimen after removal from the sealed bag, g

E = mass of the sealed specimen underwater, g

F = bag correction factor (apparent specific gravity), provided by the bag manufacturer

FOP LIBRARY

WAQTC

FOP AASHTO T 331 (21)

Example

$$G_{mb} = \frac{4833.6 \text{ g}}{4833.6 \text{ g} + 50.2 \text{ g} - 2860.4 \text{ g} - \left(\frac{50.2 \text{ g}}{0.756}\right)} = 2.470$$

Given:

A = 4833.6 g

B = 50.2 g

C = 4833.6 g

E = 2860.4 g

F = 0.756

Report

- Results on forms approved by the agency
- Sample ID
- G_{mb} to the nearest 0.001

Performance Exam Checklist

Bulk Specific Gravity (G_{mb}) and Density of Compacted Asphalt Mixtures Using Automatic Vacuum Sealing Method

FOP for AASHTO T 331

Participant Name _____ Exam Date _____

Record the symbols "P" for passing or "F" for failing on each step of the checklist.

Procedure Element	Trial 1	Trial 2
1. The tester has a copy of the current procedure on hand?	_____	_____
2. All equipment is functioning according to the test procedure, and if required has the current calibration/standardization/check and maintenance tags present?	_____	_____
3. Water bath of suitable size to entirely submerge and suspend the specimen with an adequate holder?	_____	_____
4. Water bath equipped with an overflow outlet?	_____	_____
5. Plastic bag meets requirements?	_____	_____
6. Specimen dried to constant mass?	_____	_____
7. Specimen cooled to $77 \pm 9^{\circ}\text{F}$ ($25 \pm 5^{\circ}\text{C}$) and dry mass, A, determined?	_____	_____
8. Water bath filled to overflow and allowed to stabilize at $77 \pm 1.8^{\circ}\text{F}$ ($25 \pm 1^{\circ}\text{C}$)?	_____	_____
9. Appropriate size bag selected and mass, B, determined?	_____	_____
10. Filler plates adjusted as needed?	_____	_____
11. Specimen inserted into bag with smoothest plane on bottom?	_____	_____
12. Bag centered and overlapping seal bar at least 1 in. (25 mm) with no wrinkles?	_____	_____
13. Lid closed and latched to engage operation?	_____	_____
14. Specimen carefully removed and inspected for poor seal?	_____	_____
15. If poor seal process restarted at Step 4?	_____	_____
16. Sealed specimen fully submerged, ensuring no air is trapped and bag is not touching water bath sides?	_____	_____
17. Once water level and balance stabilize, submerged weight, E, determined?	_____	_____
18. Specimen removed from bag and mass, C, determined?	_____	_____
19. If mass, C, has more than 0.08 percent lost or more than 0.04 percent gained than mass, A, process restarted at Step 1?	_____	_____
20. All calculations performed correctly?	_____	_____

First Attempt: Pass Fail

Second Attempt: Pass Fail

Signature of Examiner _____

WAQTC # _____

Comments:

WSDOT Errata to FOP for AASHTO T 335

Determining the Percentage of Fracture in Coarse Aggregate

WAQTC FOP for AASHTO T 335 has been adopted by WSDOT with the following changes:

Sampling and Sample Preparation

4. Method 2 – Individual Sieve Fracture Determination – *Method not recognized by WSDOT.*

DETERMINING THE PERCENTAGE OF FRACTURE IN COARSE AGGREGATE FOP FOR AASHTO T 335

Scope

This procedure covers the determination of the percentage, by mass, of a coarse aggregate (CA) sample that consists of fractured particles meeting specified requirements in accordance with AASHTO T 335-09.

In this FOP, a sample of aggregate is screened on the sieve separating CA and fine aggregate (FA). This sieve will be identified in the agency's specifications but might be the 4.75 mm (No. 4) sieve. CA particles are visually evaluated to determine conformance to the specified fractured criteria. The percentage of conforming particles, by mass, is calculated for comparison to the specifications.

Apparatus

- Balance or scale: Capacity sufficient for the principal sample mass, accurate to 0.1 percent of the sample mass or readable to 0.1 g and meeting the requirements of AASHTO M 231.
- Sieves: Meeting requirements of the FOP for AASHTO T 27/T 11.
- Splitter: Meeting the requirements of FOP for AASHTO R 76.

Terminology

1. Fractured criteria: Determined by the agency to define a fractured particle.
2. Fractured face: An angular, rough, or broken surface of an aggregate particle created by crushing or by other means. A face is considered a "fractured face" whenever one-half or more of the projected area, when viewed normal to that face, is fractured with sharp and well-defined edges. This excludes small nicks.
3. Fractured particle: A particle of aggregate having at least the minimum number of fractured faces specified. (This is usually one or two.)

Sampling and Sample Preparation

1. Sample and reduce the aggregate in accordance with the FOPs for AASHTO R 90 and R 76.
2. When the specifications list only a total fracture percentage, the sample shall be prepared in accordance with Method 1. When the specifications require that the fracture be counted and reported on each sieve, the sample shall be prepared in accordance with Method 2.
3. Method 1 - Combined Fracture Determination
 - a. Dry the sample sufficiently to obtain a clean separation of FA and CA material in the sieving operation.

- b. Sieve the sample in accordance with the FOP for AASHTO T 27/ T 11 over the 4.75 mm (No. 4) sieve, or the appropriate sieve listed in the agency's specifications for this material.

Note 1: Where necessary, wash the sample over the sieve designated for the determination of fractured particles to remove any remaining fine material, and dry to a constant mass in accordance with the FOP for AASHTO T 255.

- c. Reduce the sample using Method A – Mechanical Splitter, in accordance with the FOP for AASHTO R 76, to the appropriate test size. This test size should be slightly larger than shown in Table 1, to account for loss of fines through washing if necessary.

TABLE 1
Sample Size
Method 1 (Combined Sieve Fracture)

Nominal Maximum Size* mm (in.)	Minimum Cumulative Sample Mass Retained on 4.75 mm (No. 4) Sieve g (lb)
37.5 (1 1/2)	2500 (6)
25.0 (1)	1500 (3.5)
19.0 (3/4)	1000 (2.5)
12.5 (1/2)	700 (1.5)
9.5 (3/8)	400 (0.9)
4.75 (No. 4)	200 (0.4)

* One sieve larger than the first sieve to retain more than 10 percent of the material using an agency specified set of sieves based on cumulative percent retained. Where large gaps in specification sieves exist, intermediate sieve(s) may be inserted to determine nominal maximum size.

4. Method 2 – Individual Sieve Fracture Determination

- a. Dry the sample sufficiently to obtain a clean separation of FA and CA material in the sieving operation. A washed sample from the gradation determination (the FOP for T 27/T 11) may be used.
- b. If not, sieve the sample in accordance with the FOP for AASHTO T 27 over the sieves listed in the specifications for this material.

Note 2: If overload (buffer) sieves are used the material from that sieve must be added to the next specification sieve.

- c. The size of test sample for each sieve shall meet the minimum size shown in Table 2. Utilize the total retained sieve mass or select a representative portion from each sieve mass by splitting or quartering in accordance with the FOP for AASHTO R 76.

Note 3: Where necessary, wash the sample over the sieves designated for the determination of fractured particles to remove any remaining fine material, and dry to a constant mass in accordance with the FOP for AASHTO T 255.

TABLE 2
Sample Size
Method 2 (Individual Sieve Fracture)

Sieve Size mm (in.)	Minimum Sample Mass g (lb)
31.5 (1 1/4)	1500 (3.5)
25.0 (1)	1000 (2.2)
19.0 (3/4)	700 (1.5)
16.0 (5/8)	500 (1.0)
12.5 (1/2)	300 (0.7)
9.5 (3/8)	200 (0.5)
6.3 (1/4)	100 (0.2)
4.75 (No. 4)	100 (0.2)
2.36 (No. 8)	25 (0.1)
2.00 (No. 10)	25 (0.1)

Note 4: If fracture is determined on a sample obtained for gradation, use the mass retained on the individual sieves, even if it is less than the minimum listed in Table 2. If less than 5 percent of the total mass is retained on a single specification sieve, include that material on the next smaller specification sieve. If a smaller specification sieve does not exist, this material shall not be included in the fracture determination.

Procedure

1. After cooling, spread the dried sample on a clean, flat surface.
2. Examine each particle face and determine if the particle meets the fractured criteria.
3. Separate the sample into three categories:
 - Fractured particles meeting the criteria
 - Particles not meeting the criteria
 - Questionable or borderline particles
4. Determine the dry mass of particles in each category to the nearest 0.1 g.
5. Calculate the percent questionable particles to the nearest 1 percent.
6. Re-sort the questionable particles when more than 15 percent is present. Continue sorting until there is no more than 15 percent in the questionable category.
7. Calculate the percent fractured particles meeting criteria to nearest 0.1 percent. Report to 1 percent.

Calculation

Calculate the percent questionable particles to the nearest 1 percent using the following formula:

$$\%Q = \frac{Q}{F + Q + N} \times 100$$

Where:

- %Q = Percent of questionable particles
- F = Mass of fractured particles
- Q = Mass of questionable or borderline particles
- N = Mass of unfractured particles

Example:

$$\%Q = \frac{97.6 \text{ g}}{632.6 \text{ g} + 97.6 \text{ g} + 352.6 \text{ g}} \times 100 = 9\%$$

Given:

- F = 632.6 g
- Q = 97.6 g
- N = 352.6 g

Calculate the percent fractured particles to the nearest 0.1 percent using the following formula:

$$P = \frac{\frac{Q}{2} + F}{F + Q + N} \times 100$$

Where:

- P = Percent of fractured particles
- F = Mass of fractured particles
- Q = Mass of questionable particles
- N = Mass of unfractured particles

AGGREGATE

WAQTC

FOP AASHTO T 335 (22)

Example:

$$P = \frac{\frac{97.6 \text{ g}}{2} + 632.6 \text{ g}}{632.6 \text{ g} + 97.6 \text{ g} + 352.6 \text{ g}} \times 100 = 62.9\% \quad \text{Report 63\%}$$

Given:

$$F = 632.6 \text{ g}$$

$$Q = 97.6 \text{ g}$$

$$N = 352.6 \text{ g}$$

Report

- On forms approved by the agency
- Sample ID
- Fractured particles to the nearest 1 percent.

AGGREGATE

WAQTC

FOP AASHTO T 335 (22)

41_T335_short_22_errata

Aggregate 13-6

Pub. October 2022

PERFORMANCE EXAM CHECKLIST

**DETERMINING THE PERCENTAGE OF FRACTURE IN COARSE AGGREGATE
FOP FOR AASHTO T 335**

Participant Name _____ Exam Date _____

Record the symbols "P" for passing or "F" for failing on each step of the checklist.

Procedure Element	Trial 1	Trial 2
1. Sample properly sieved through specified sieve(s)?	_____	_____
2. Sample reduced to correct size?	_____	_____
3. Sample dried and cooled, if necessary?	_____	_____
4. Each particle examined to determine if the particle meets the fractured criteria?	_____	_____
5. Particles separated into fractured, unfractured, and questionable categories?	_____	_____
6. Dry mass of each category determined to nearest 0.1 g?	_____	_____
7. Questionable category resorted if more than 15 percent of total mass falls in that category?	_____	_____
8. Fractured calculation performed correctly?	_____	_____

Comments: First attempt: Pass _____ Fail _____ Second attempt: Pass _____ Fail _____

Examiner Signature _____ WAQTC #: _____

| AGGREGATE

WAQTC

FOP AASHTO T 335 (22)

WSDOT Errata to FOP for AASHTO T 355

In-Place Density of Asphalt Mixtures by Nuclear Methods

WAQTC FOP for AASHTO T 355 has been adopted by WSDOT with the following changes:

Material

Filler material: *Not used by WSDOT, unless SMA is being placed, then use filler material as described.*

Test Site Location

Replace step 1 with below:

1. WSDOT requires test location selected per WSDOT Test Method 716.

Procedure

Method A – Average of two one-minute tests - Not recognized by WSDOT use Method B:

Calculation of Results

Percent (%) compaction is determined by comparing the in-place wet density as determined by this method to the average Theoretical Maximum Density of the asphalt mixture as determined by WSDOT SOP 729.

Use the following equations to calculate the percent of compaction:

1. Calculate the corrected gauge reading to the nearest tenth as follows:

$$\text{Corrected Gauge Reading} = \text{Wet Density} \times \text{Gauge Correlation Factor}$$

Method B Example:

Reading:	140.8 lb/ft ³
Gauge correlation factor:	× 1.015
Corrected reading =	142.9 lb/ft ³

2. Calculate the percent compaction to the nearest tenth as follows.

$$\% \text{ Compaction} = \frac{\text{Corrected Reading}}{\text{Maximum Density}} \times 100$$

% Compaction Example:

Corrected reading:	142.9 lb/ft ³
Maximum Density:	2.466

$$\text{Theoretical Maximum Density} = 2.466 \times 62.245 \text{ lb/ft}^3 = 153.5 \text{ lb/ft}^3$$

$$\% \text{ Compaction} = \frac{142.9 \text{ lb/ft}^3}{153.5 \text{ lb/ft}^3} \times 100 = 93.1\%$$

APPENDIX – CORRELATION WITH CORES

Correlation with Cores

Replace step 2 with below:

2. Obtain a pavement core from each of the test sites according to WSDOT SOP 734. The core should be taken from the center of the nuclear gauge footprint.
4. Determine and calculate gauge correlation factor according to WSDOT SOP 730.

IN-PLACE DENSITY OF ASPHALT MIXTURES BY NUCLEAR METHODS FOP FOR AASHTO T 355

Scope

This test method describes a procedure for determining the density of asphalt mixtures by means of a nuclear gauge using the backscatter method in accordance with AASHTO T 355-22. Correlation with densities determined under the FOP for AASHTO T 166 is required by some agencies.

Apparatus

- Nuclear density gauge with the factory-matched standard reference block.
- Transport case for properly shipping and housing the gauge and tools.
- Instruction manual for the specific make and model of gauge.
- Radioactive materials information and calibration packet containing:
 - Daily standard count log
 - Factory and laboratory calibration data sheet
 - Leak test certificate
 - Shippers' declaration for dangerous goods
 - Procedure memo for storing, transporting, and handling nuclear testing equipment
 - Other radioactive materials documentation as required by local regulatory requirements

Material

- Filler material: Fine-graded sand from the source used to produce the asphalt pavement or other agency approved materials.

Radiation Safety

This method does not purport to address all of the safety problems associated with its use. This test method involves potentially hazardous materials. The gauge utilizes radioactive materials that may be hazardous to the health of the user unless proper precautions are taken. Users of this gauge must become familiar with the applicable safety procedures and governmental regulations. All operators will be trained in radiation safety before operating nuclear density gauges. Some agencies require the use of personal monitoring devices such as a thermoluminescent dosimeter or film badge. Effective instructions, together with routine safety procedures such as source leak tests, recording and evaluation of personal monitoring device data, etc., are a recommended part of the operation and storage of this gauge.

Calibration

Calibrate the nuclear gauge as required by the agency. This calibration may be performed by the agency using the manufacturer's recommended procedures or by other facilities approved by the agency. Verify or re-establish calibration curves, tables, or equivalent coefficients every 12 months.

Standardization

1. Turn the gauge on and allow it to stabilize (approximately 10 to 20 minutes) before standardization. Leave the power on during the day's testing.
2. Standardize the nuclear gauge at the construction site at the start of each day's work and as often as deemed necessary by the operator or agency. Daily variations in standard count shall not exceed the daily variations established by the manufacturer of the gauge. If the daily variations are exceeded after repeating the standardization procedure, the gauge should be repaired, recalibrated, or both.
3. Record the standard count for both density and moisture in the daily standard count log. The exact procedure for standard count is listed in the manufacturer's Operator's Manual.

Note 1: New standard counts may be necessary more than once a day. See agency requirements.

Test Site Location

1. Select a test location(s) randomly and in accordance with agency requirements. Test sites should be relatively smooth and flat and meet the following conditions:
 - a. At least 10 m (30 ft.) away from other sources of radioactivity.
 - b. At least 3 m (10 ft.) away from large objects.
 - c. If the gauge will be closer than 600 mm (24 in.) to any vertical mass, or less than 300 mm (12 in.) from a vertical pavement edge, use the gauge manufacturer's correction procedure.

Procedure

1. Maintain maximum contact between the base of the gauge and the surface of the material under test.
2. Use filler material to fill surface voids.
3. Spread a small amount of filler material over the test site surface and distribute it evenly. Strike off the surface with a straightedge (such as a lathe or flat-bar steel) to remove excess material.
4. If using thin-layer mode, enter the anticipated overlay thickness into the gauge.

Note 2: If core correlation is required, entered thickness, anticipated thickness, and nominal core thickness may be required to match.

Method A – Average of two one-minute tests

1. Place the gauge on the test site, perpendicular to the roller passes.
2. Using a crayon (not spray paint), mark the outline or footprint of the gauge.
3. Extend the source rod to the backscatter position.
4. Take a one-minute test and record the wet density reading.
5. Rotate the gauge 90 degrees centered over the original footprint. Mark the outline or footprint of the gauge.
6. Take another one-minute test and record the wet density reading.
7. If the difference between the two one-minute tests is greater than 40 kg/m^3 (2.5 lb/ft^3), retest in both directions. If the difference of the retests is still greater than 40 kg/m^3 (2.5 lb/ft^3) test at 180 and 270 degrees.
8. The density reported for each test site shall be the average of the two individual one-minute wet density readings.

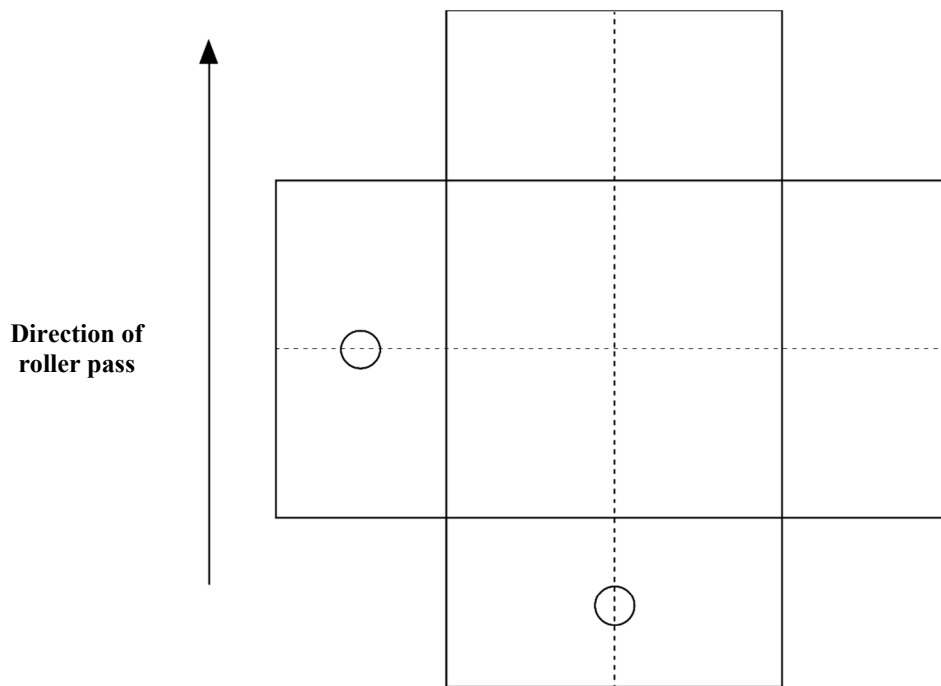
**Method A****Footprint of the gauge test site**

Method B – One four-minute test

1. Place the gauge on the test site, parallel to the roller passes.
2. Using a crayon (not spray paint), mark the outline or footprint of the gauge.
3. Extend the source rod to the backscatter position.
4. Take one 4-minute test and record the wet density reading.

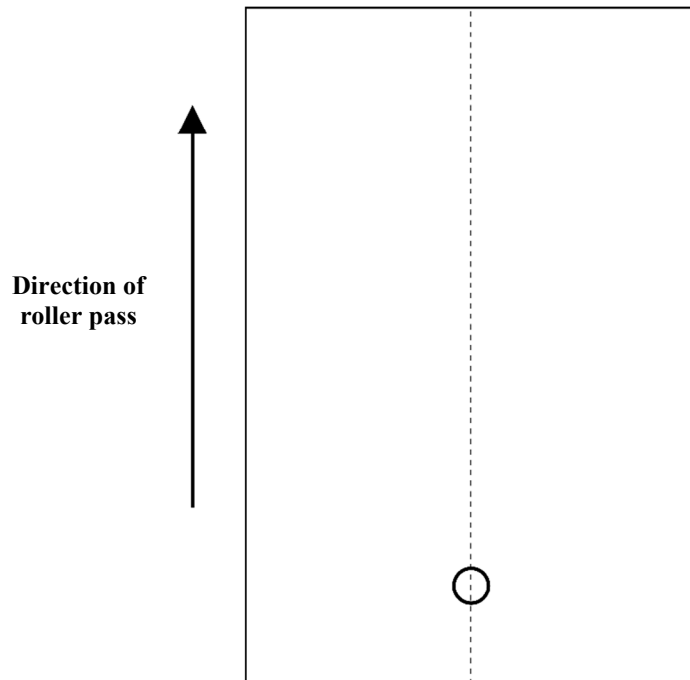
**Method B****Footprint of the gauge test site**

Calculation of Results

Percent (%) compaction is determined by comparing the in-place wet density as determined by this method to the appropriate agency density standard. See appropriate agency policy for use of density standards.

$$\% \text{ Compaction} = \frac{\text{Corrected Reading}}{\text{Maximum Density}} \times 100$$

Method A Example:

Reading #1: 141.5 lb/ft³

Reading #2: 140.1 lb/ft³ Are the two readings within the tolerance? (YES)

Reading average: 140.8 lb/ft³

Core correction: +2.1 lb/ft³

Corrected reading: 142.9 lb/ft³

Method B Example:

Reading: 140.8 lb/ft³

Core correction: +2.1 lb/ft³

Corrected reading 142.9 lb/ft³

Example percent (%) compaction:

From the FOP for AASHTO T 209:

$$G_{mm} = 2.466$$

$$\text{Theoretical Maximum Density} = 2.466 \times 62.245 \text{ lb/ft}^3 = 153.5 \text{ lb/ft}^3$$

$$\% \text{ Compaction} = \frac{142.9 \text{ lb/ft}^3}{153.5 \text{ lb/ft}^3} \times 100 = 93.1\%$$

Report

- On forms approved by the agency
- Test ID
- Location of test and thickness of layer tested
- Mixture type
- Make, model and serial number of the nuclear moisture-density gauge
- Calculated wet density of each measurement and any adjustment data
- Density standard
- Compaction to the nearest 0.1 percent
- Name and signature of operator

APPENDIX – CORRELATION WITH CORES

(Nonmandatory Information)

The bulk specific gravity (G_{mb}) of the core is a physical measurement of the in-place asphalt mixture and can be compared with the nuclear density gauge readings. Comparing the core value to the corresponding gauge values, a correlation can be established.

The correlation can then be used to adjust the gauge readings to the in-place density of the cores. The core correlation is gauge specific and must be determined without traffic allowed on the pavement between nuclear density gauge readings and obtaining the core. When using multiple nuclear density gauges each gauge should be correlated to the core locations before removal of the core.

When density correlation with the FOP for AASHTO T 166 is required, correlation of the nuclear gauge with pavement cores shall be made on the first day's paving (within 24 hours) or from a test strip constructed before the start of paving. Cores must be taken before traffic is allowed on the pavement.

Correlation with Cores

1. Determine the number of cores required for correlation from the agency's specifications. Cores shall be located on the first day's paving or on the test strip. Locate the test sites in accordance with the agency's specifications. Follow the "Procedure" section above to establish test sites and obtain densities using the nuclear gauge.
2. Obtain a pavement core from each of the test sites according to AASHTO R 67. The core should be taken from the center of the nuclear gauge footprint.

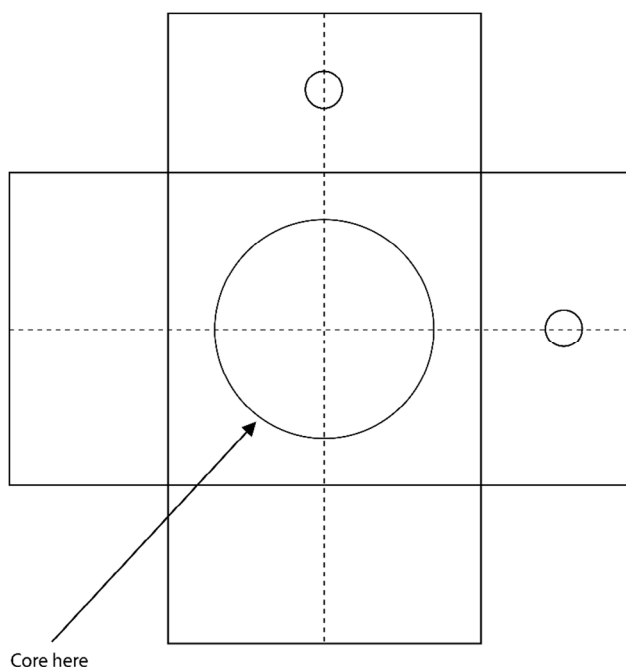

Method A – Footprint of the gauge test site. Core location in the center of the footprint.

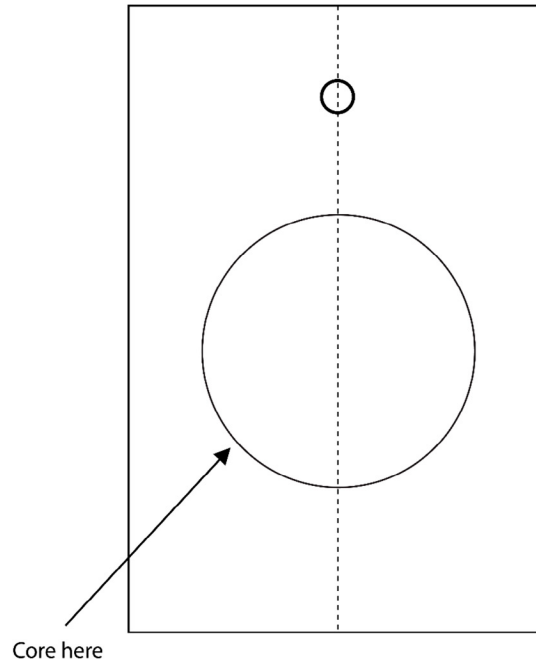

Method B - Footprint of the gauge test site.

3. Determine the density of the cores by the FOP for AASHTO T 166, Bulk Specific Gravity of Compacted Asphalt Mixtures Using Saturated Surface Dry Specimens.
4. Calculate a correlation factor for the nuclear gauge reading as follows:
 - a. Calculate the difference between the core density and the average nuclear gauge density at each test site to the nearest 1 kg/m^3 (0.1 lb/ft^3). Calculate the average difference and standard deviation of the differences for the entire data set to the nearest 1 kg/m^3 (0.1 lb/ft^3).
 - b. If the standard deviation of the differences is equal to or less than 40 kg/m^3 (2.5 lb/ft^3), the correlation factor applied to the average nuclear gauge density shall be the average difference calculated above in 4.a.
 - c. If the standard deviation of the differences is greater than 40 kg/m^3 (2.5 lb/ft^3), the test site with the greatest variation from the average difference shall be eliminated from the data set and the data set properties and correlation factor recalculated following 4.a and 4.b.
 - d. If the standard deviation of the modified data set still exceeds the maximum specified in 4.b, additional test sites will be eliminated from the data set and the data set properties and correlation factor recalculated following 4.a and 4.b. If the data set consists of less than five test sites, additional test sites shall be established.

Note A1: The exact method used in calculating the nuclear gauge correlation factor shall be defined by agency policy.

Note A2: The above correlation procedure must be repeated if there is a new job mix formula. Adjustments to the job mix formula beyond tolerances established in the contract documents will constitute a new

job mix formula. A correlation factor established using this procedure is only valid for the particular gauge used in the correlation procedure. If another gauge is brought onto the project, it shall be correlated using the same procedure. Multiple gauges may be correlated from the same series of cores if done at the same time.

Note A3: For the purpose of this procedure, a job mix formula is defined as the percent and grade of paving asphalt used with a specified gradation of aggregate from a designated aggregate source. A new job mix formula may be required whenever compaction of the wearing surface exceeds the agency's specified maximum density or minimum air voids.

Calculations

Correlation Factor

$$\sqrt{\frac{\sum x^2}{n-1}}$$

Where:

Σ = Sum

x = Difference from the average Difference

n-1 = number of data sets minus 1

Example

Core #	Core results from T 166:	Average Gauge reading	Difference:	x	x ²
1	144.9 lb/ft ³	142.1 lb/ft ³	2.8 lb/ft ³	-0.7	0.49
2	142.8 lb/ft ³	140.9 lb/ft ³	1.9 lb/ft ³	0.2	0.04
3	143.1 lb/ft ³	140.7 lb/ft ³	2.4 lb/ft ³	-0.3	0.09
4	140.7 lb/ft ³	138.9 lb/ft ³	1.8 lb/ft ³	0.3	0.09
5	145.1 lb/ft ³	143.6 lb/ft ³	1.5 lb/ft ³	0.6	0.36
6	144.2 lb/ft ³	142.4 lb/ft ³	1.8 lb/ft ³	0.3	0.09
7	143.8 lb/ft ³	141.3 lb/ft ³	2.5 lb/ft ³	-0.4	0.16
8	142.8 lb/ft ³	139.8 lb/ft ³	3.0 lb/ft ³	0.9	0.81
9	144.8 lb/ft ³	143.3 lb/ft ³	1.5 lb/ft ³	-0.6	0.36
10	143.0 lb/ft ³	141.0 lb/ft ³	2.0 lb/ft ³	-0.1	<u>0.01</u>
Average Difference:			+2.1 lb/ft ³	$\Sigma x^2 = 2.5$	

IN-PLACE DENSITY

WAQTC

FOP AASHTO T 355 (22)

Number of data sets

$$n - 1 = 10 - 1 = 9$$

Standard deviation

$$\text{standard deviation} = \sqrt{\frac{2.5}{9}} = 0.53$$

Given:

$$\text{Sum of } x^2 = 2.5$$

$$\text{Number of data sets} = 9$$

The standard deviation of 0.53 is less than 2.5 therefore no cores are eliminated. The average difference from all ten cores is used.

PERFORMANCE EXAM CHECKLIST

**IN-PLACE DENSITY OF ASPHALT MIXTURES BY NUCLEAR METHODS
FOP FOR AASHTO T 355**

Participant Name _____ Exam Date _____

Record the symbols “P” for passing or “F” for failing on each step of the checklist.

Procedure Element	Trial 1	Trial 2
1. Gauge turned on approximately 10 to 20 minutes before use?	_____	_____
2. Gauge calibrated, and standard count recorded?	_____	_____
3. Test location selected appropriately [600 mm (24 in.) from vertical projections or 10 m (30 ft.) from any other radioactive sources]?	_____	_____
4. Filler spread evenly over test site?	_____	_____
5. Excess filler material removed by striking off the surface?	_____	_____
6. Gauge placed on pavement surface and footprint of gauge marked?	_____	_____
7. Source rod extended to backscatter position?	_____	_____
8. Method A:		
a. One-minute count taken; gauge rotated 90°, resealed, and another one-minute count taken?	_____	_____
b. Densities averaged?	_____	_____
c. If difference of the wet densities is greater than 40 kg/m ³ (2.5 lb/ft ³), retest conducted in both directions?	_____	_____
9. Method B:		
a. One four-minute count taken?	_____	_____
10. Core correlation applied if required?	_____	_____
11. Percent compaction calculated correctly?	_____	_____

Comments: First attempt: Pass _____ Fail _____ Second attempt: Pass _____ Fail _____

Examiner Signature _____ WAQTC #: _____

IN-PLACE DENSITY

WAQTC

FOP AASHTO T 355 (20)



WSDOT SOP 730

Correlation of Nuclear Gauge Densities With Hot Mix Asphalt (HMA) Cores

1. When evaluating HMA compaction:

1.1 A gauge correlation is required:

- a. For each combination of gauge and HMA Mix Design (initial JMF).
- b. When gauge mode changes (i.e., back scatter to thin layer).
- c. When wearing course lift thickness changes per Note 1.
- d. When a gauge is recalibrated.

Note 1: For density determined with "Thin Layer Mode," a layer thickness change of greater than 0.08 feet requires a new correlation. For density determined with "Back Scatter Mode," a layer thickness change of greater than 0.15 feet requires a new gauge correlation.

1.2 A gauge correlation is not required but may be considered by the Regional Materials Engineer when:

- a. Base material changes from the original correlation base (i.e., from a surfacing base to an asphalt base).
- b. The same gauge HMA Mix Design (Reference Mix Design) combination are used on a different contract within the same construction year.
- c. When JMF has been adjusted in accordance with [Standard Specifications](#) Section 9-03.8(7)A.

2. Gauge correlation is based on ten in-place HMA densities and ten cores taken at the same location as the in-place density.
 - 2.1 In-place HMA densities shall be determined in accordance with WSDOT FOP for WAQTC T 355.
 - 2.2 Cores should be taken no later than the day following paving and before traffic has been allowed on roadway. Correlation cores are not required to be taken at record density locations. Therefore, a site outside the traveled way should be considered for worker safety, as long as the lift thickness matches that of the plan lift thickness of the record density locations.

Note 2: If a core becomes damaged, it shall be eliminated from the average.

Note 3: Cores may be taken sooner than the day after paving if the HMA is cooled to prevent damage during coring and removal of cores. Water, ice, or dry-ice may be used to cool the pavement. Another method of cooling that may be used is substitution of nitrogen gas or CO₂ for drilling fluids.

3. Obtain a pavement core from each of the test sites in accordance with WSDOT SOP 734. The core shall be taken in the nuclear gauge footprint.
 - 3.1 For either gauge mode, back scatter or thin layer, locate the core in the approximate center of the nuclear gauge footprint. If the core thickness exceeds the plan pavement thickness by more than 0.04 feet, then the core shall be saw cut to the plan thickness prior to performing density testing. If a core thickness is less than the plan thickness by more than 0.04 feet, it shall be eliminated from the average.
4. Bulk Specific Gravity (G_{mb}) of core shall be determined in conformance with WSDOT FOP for AASHTO T 166 Bulk Specific Gravity of Compacted Hot Mix Asphalt (HMA) Using Saturated Surface-Dry Specimens.

Calculate core density as follows, round to the nearest 0.1 pcf:

$$\text{Core Density} = G_{mb} \times 62.245 \text{ pcf}$$

Calculate gauge correlation factor as follows:

$$\text{Density Ratio} = \frac{(\text{core density})}{(\text{nuclear gauge wet density})}$$

Round Density Ratio to the nearest 0.001

$$\text{Gauge correlation factor} = \frac{(\text{Sum of ratios})}{(\text{number of cores})}$$

5. Gauge Correlation Factor shall be determined to 0.001.
6. Report the Gauge Correlation Factor using MATS or DOT [Form 350-112](#).