



**Washington State  
Department of Transportation**

---

# **Pavement Policy**

**SEPTEMBER 2018**

MULTIMODAL DEVELOPMENT AND DELIVERY  
STATE PAVEMENT OFFICE

## Americans with Disabilities Act (ADA) Information

### English

**Title VI Notice to Public** It is the Washington State Department of Transportation's (WSDOT) policy to assure that no person shall, on the grounds of race, color, national origin or sex, as provided by Title VI of the Civil Rights Act of 1964, be excluded from participation in, be denied the benefits of, or be otherwise discriminated against under any of its federally funded programs and activities. Any person who believes his/her Title VI protection has been violated, may file a complaint with WSDOT's Office of Equal Opportunity (OEO). For additional information regarding Title VI complaint procedures and/or information regarding our non-discrimination obligations, please contact OEO's Title VI Coordinator at 360-705-7090.

**Americans with Disabilities Act (ADA) Information** This material can be made available in an alternate format by emailing the Office of Equal Opportunity at [wsdotada@wsdot.wa.gov](mailto:wsdotada@wsdot.wa.gov) or by calling toll free, 855-362-4ADA(4232). Persons who are deaf or hard of hearing may make a request by calling the Washington State Relay at 711.

### Spanish

**Notificación de Título VI al Público** Es la póliza de el Departamento de Transportes del Estado de Washington de asegurar que ninguna persona sea excluida de participación o sea negado los beneficios, o sea discriminado bajo cualquiera de sus programas y actividades financiado con fondos federales sobre la base de raza, color, origen nacional o sexo, como proveído por el Título VI de el Acto de Derechos Civiles de 1964. Cualquier persona que cree que sus protecciones de Título VI han sido violadas, puede hacer una queja con la Oficina de Igualdad de Oportunidades (OEO). Para información adicional con respecto a procedimientos de quejas de Título VI y/o información con respecto a nuestras obligaciones sin discriminación, por favor de comunicarse con el Coordinador de Título VI de la Oficina de Igualdad de Oportunidades (OEO) 360-705-7090.

### Información del Acta Americans with Disabilities Act (ADA)

Este material es disponible en un formato alternative. Envíe su petición por correo electrónico al equipo de Oficina de Igualdad de Oportunidades (OEO) en [wsdotada@wsdot.wa.gov](mailto:wsdotada@wsdot.wa.gov) o llamando gratis, 855-362-4ADA (4232). Personas sordas o con problemas de audición pueden solicitar llamando el relé de estado de Washington al 711. For public events (like Open Houses, etc) English Accommodation requests for people with disabilities can be made by contacting the WSDOT Diversity/ADA Affairs team at [wsdotada@wsdot.wa.gov](mailto:wsdotada@wsdot.wa.gov) or by calling toll-free, 855-362-4ADA (4232). Persons who are deaf or hard of hearing may make a request by calling the Washington State Relay at 711. Spanish Solicitudes de alojamiento para personas con discapacidad pueden hacer comunicándose con el equipo de Asuntos de diversidad/ADA WSDOT en [wsdotada@wsdot.wa.gov](mailto:wsdotada@wsdot.wa.gov) o llamando al número gratuito, 855-362-4ADA (4232). Personas sordas o con problemas de audición pueden solicitar llamando el relé del estado de Washington al 711.

Washington State Department of Transportation  
Multimodal Development and Delivery  
Pavement Office

PO Box 47365 Olympia, WA 98504-7365

[www.wsdot.wa.gov/Business/MaterialsLab/Pavements/Default.htm](http://www.wsdot.wa.gov/Business/MaterialsLab/Pavements/Default.htm)

# TABLE OF CONTENTS

1.	INTRODUCTION	1
1.1	Purpose	1
1.2	Relationship to WSDOT Design Manual	1
1.3	Scope and Applicability	1
2.	BASIS OF WSDOT DESIGN POLICY	3
2.1	Background	3
2.2	PCCP	3
2.3	HMA Pavement	5
2.4	Surface Treatment Pavements	6
2.5	Re-use of Existing Pavement Structures	6
2.6	Pavement Preservation	7
3.	PAVEMENT DESIGN CONSIDERATIONS	9
3.1	Design Period	9
3.2	Traffic	9
3.3	Subgrade Soils	10
3.4	Frost Action	10
3.5	Design Resources	10
4.	PAVEMENT TYPE SELECTION	13
4.1	Application of Pavement Type Selection	13
4.2	Submittal Process	14
5.	NEW PAVEMENT DESIGN	17
5.1	Design Procedures	17
5.2	Determination of Flexible Pavement Layer Thicknesses	17
5.3	Determination of Rigid Pavement Layer Thicknesses	22
5.4	Permeable Pavements	24
6.	PAVEMENT REHABILITATION	27
6.1	Cold In-Place Recycling	27
6.2	Full Depth Reclamation	29
6.3	Crack, Seal and Overlay	29
6.4	Unbonded PCCP Overlay	30
6.5	HMA Structural Overlay	31
7.	PAVEMENT PRESERVATION	33
7.1	Chip Seals	33
7.2	Hot Mix Asphalt	36
7.3	PCCP	41

7.4	Other Pavement Preservation Treatments	43
7.5.	Strategic Maintenance	45
7.6.	Skid Collision Reduction Policy	46
8.	DESIGN DETAILS	51
8.1	General Design Details	51
8.2	HMA Design Details	52
8.3	PCCP Design Details	55
9.	PAVEMENT DESIGN REPORT	57
9.1	Project Description	57
9.2	Site Evaluation	58
9.3	Pavement Design	59
9.4	Design Details	59
9.5	State Pavement office Pavement Design Report Approval	60
	REFERENCES	61
	APPENDIX 1 – DOWEL BAR TYPE SELECTION	67
	APPENDIX 2 – FROST DEPTH CONTOUR MAPS	71
	APPENDIX 3 – PAVEMENT TYPE SELECTION CRITERIA	75
	APPENDIX 4 – EXAMPLE PAVEMENT TYPE SELECTION REPORT	89
	APPENDIX 5 – WSDOT PROBABILISTIC INPUTS	117
	APPENDIX 6 – PROBABILISTIC ANALYSIS EXAMPLE	121
	APPENDIX 7 – PROJECT SPECIFIC DETAILS	133
	APPENDIX 8 – WSDOT PAVEMENT TYPE SELECTION COMMITTEE AND SAMPLE MEMORANDUM	135
	APPENDIX 9 - BASIS OF WSDOT PAVEMENT DESIGN POLICY FOR DESIGN BUILD PROJECTS	139

## **1. INTRODUCTION**

### **1.1 PURPOSE**

The purpose of this document is to establish a uniform policy for the selection of pavement types, design of pavement structures, determining rehabilitation methods and selecting pavement materials for use by Washington State Department of Transportation (WSDOT) pavement designers throughout the state. It is not intended as a replacement for engineering judgment. Nor is it a comprehensive manual on pavement design and designers using this document should have a basic understanding of pavement design, pavement construction and paving materials.

### **1.2 RELATIONSHIP TO WSDOT DESIGN MANUAL**

Pavement design information previously contained in the Design Manual is largely replaced by this document. Refer to Division 6 of the Design Manual for any additional pavement related information.

### **1.3 SCOPE AND APPLICABILITY**

This manual is intended for design of highway pavement and other facilities that are part of Washington's highway system. Facilities owned by WSDOT but not part of the highway system are not required to comply with this document. Pavement and facilities maintained by local agencies should be designed to the standards of the local agency.

This manual contains standards for selecting pavement types, designing pavement structures and selecting pavement materials. Specific requirements for pavement materials are covered in other WSDOT manuals including the Standard Specifications and the Materials Manual.

This document is maintained by the Multimodal Development and Delivery Construction Division State Pavement Office (State Pavement Office). The State Pavement Office should be contacted with any questions regarding this manual.



## **2. BASIS OF WSDOT DESIGN POLICY**

### **2.1 BACKGROUND**

WSDOT's pavement design policy is a product of experience, research findings (state, national and international) and various analyses. The policy is based upon pavement design practices that WSDOT has found to produce serviceable and cost effective pavements for the conditions in Washington State. Generally, these practices follow conventional pavement design procedures. Practices that have shaped WSDOT's pavement design policy include:

- Designing pavement structures for long-life (50 years or more),
- Designing HMA pavement to ensure that cracking occurs from the top down instead of from the bottom up,
- Reusing the existing pavement structure as much as practical when rehabilitating an existing pavement, and
- Incorporating pavement preservation at both the capital project level as well as the state forces maintenance level.

These practices are the basis of many of the requirements in this pavement design policy. Background information describing how these practices came about is provided in following sections.

### **2.2 PCCP**

The policy of designing long-life portland cement concrete pavement (PCCP) grew out of the historical performance of PCCP in Washington. Paving concrete used in Washington has historically performed well structurally and has not suffered from any significant durability problems. The limiting failure mechanisms have been those that do not involve the concrete material itself such as faulting, roughness and studded tire wear. The performance of the paving concrete makes long life PCCP feasible provided the non-concrete material related failure mechanisms are designed to perform over a long design life. The following describes the strategies used by WSDOT for each PCCP design element to design long life PCCP.

### **2.2.1 THICKNESS**

WSDOT designed the PCCP constructed during the 1960's and 1970's as part of the original interstate construction with an 8 or 9 inch thickness. Originally designed for a 20-year life, many are still in service, far exceeding their design lives; although most have required rehabilitation activities such as dowel bar retrofits and grinding. With a moderate increase in thickness to account for increased equivalent single axle loads (ESALs), the structural performance of the earlier pavements show that PCCP in Washington could be constructed to resist structural failure for 50 years or more.

Washington allows studded tires from November through March. Rutting (wear) in the wheel paths due to studded tires has been deep enough to require correction on some PCCP sections. Wear due to studded tires will continue to be a problem. WSDOT designs new PCCP with an extra inch of thickness to account for diamond grinding to remove ruts caused by studded tire wear.

### **2.2.2 DURABILITY**

PCCP in Washington have not suffered from significant durability problems that can limit pavement life in other parts of the country. The durability of Washington's PCCP primarily arises from the availability of high quality aggregates. Supplies of high quality aggregates appear to be available for the foreseeable future allowing the production of concrete that can provide a long pavement life.

### **2.2.3 JOINTING AND LOAD TRANSFER**

A major failure mechanism that affected the performance of WSDOT's original PCCP sections was load transfer at transverse joints. Originally constructed without dowel bars, PCCP was susceptible to faulting. Many of these PCCP sections required rehabilitation in the form of dowel bar retrofits and grinding. To address faulting, new pavements are doweled to improve joint load transfer.

Experience has shown that spacing transverse contraction joints at 15 feet did not result in significant amounts of shrinkage cracking. The 15-foot spacing was retained as the standard spacing for transverse contraction joints.



#### **2.2.4 DOWEL BAR MATERIALS**

A long pavement life necessitates that dowel bars be able to resist corrosion. Inspection of epoxy coated dowel bars removed from in service pavements revealed that they are susceptible to corrosion under Washington conditions. To achieve a long life, WSDOT requires stainless steel or equivalent dowels in all new PCCP (see Appendix 1 for dowel bar materials). Epoxy coated dowel bars are allowed in applications that do not have as long of a life such as dowel bar retrofits and replacing damaged panels in an existing PCCP.

#### **2.2.5 PCCP BASE**

In the past, base depths under PCCP were determined primarily by the requirement for support of construction traffic. Currently, it is recognized that the layer directly beneath PCCP slabs is a critical element in the performance of PCCP. WSDOT has previously used asphalt treated base (ATB) to support construction traffic prior to placement of PCCP. Subsequent WSDOT experience has indicated variable performance for ATB material beneath various Interstate PCCP. For this reason, HMA base is required as the supporting layer for PCCP slabs for high traffic roadways.

### **2.3 HMA PAVEMENT**

WSDOT's bases its long-life HMA design policy on constructing thicker pavements so that cracking will primarily be top down. Cracks in HMA pavements, thicker than approximately 6 inches, tend to start at the top of the pavement and propagate down instead of starting at the bottom and propagating up. By correcting surface distress on a thicker HMA pavement before it propagates into the lower layers, the underlying structure can be preserved allowing the pavement to have a long life.

#### **2.3.1 THICKNESS**

Traditional HMA pavement design methods have focused on providing a structure that limits the amount of bottom-up cracking over the pavement's life. This method can allow the use of thinner HMA thicknesses which reduce costs during the initial construction. In these methods, cracking starts at the bottom of the pavement and progress upwards through the entire pavement structure. At the end of the pavement's life, bottom-up cracking becomes widespread resulting in the pavement losing its ability to carry loads. Restoring the load carrying capacity requires a costly rehabilitation or reconstruction that usually requires replacement or reprocessing of the existing HMA pavement structure. WSDOT has found that cracking in thicker HMA pavement occurs from

the top down. If timely preservation is performed to correct the top-down cracking, damage to the underlying layers can be prevented thus preserving the pavement structure. It is WSDOT's policy to use a long design life that results in a relatively thick HMA pavement structure. The thick HMA pavement can then be preserved using thin mill and inlay projects that remove the top-down cracks by milling off the top lift of HMA and inlaying with an equal thickness of new HMA. The thicker pavement costs more for initial construction but this cost is offset by the savings realized by the lower cost to preserve the pavement.

### **2.3.2 HMA PRESERVATION**

The goal of HMA preservation is to protect the underlying structure by replacing top layers before distress that initiates at the top of the pavement damages the underlying structural layers. WSDOT employs two complimentary strategies to preserve HMA pavement. The first is the thin mill and inlay mentioned above. The goal of the mill and inlay is to remove the top layer of HMA which eliminates most of the top-down cracks and the aged, crack-susceptible top layer of HMA and replaces it with new HMA. The second strategy is to use preservation treatments such as crack sealing, surface treatments and patching to extend the time between the thin mill and inlay projects.

### **2.4 SURFACE TREATMENT PAVEMENTS**

Chip seals are a major surface treatment used by WSDOT due to their simplicity, low cost and the ability to withstand studded tire wear. Although they are not often thought of as long-life pavement structures, the underlying pavement structure on a chip seal roadway can have a long life. This requires that additional chip seals be periodically applied to prevent water intrusion and damage to the underlying structure. Despite the frequent reapplication of the chip seal surface, these types of roadway can have a much lower life cycle cost than PCCP or HMA roadways provided the location and traffic levels are appropriate.

### **2.5 RE-USE OF EXISTING PAVEMENT STRUCTURES**

For existing pavement structures that require significant structural enhancements, long-lasting pavements can be achieved by incorporation of the existing pavement. Structural designs that incorporate the existing pavement are similar to new pavement designs but considerations associated with the existing pavement are required. A reliable procedure is available that identifies when existing pavements can be used in-place and the methods necessary to

incorporate the original material into the new pavement structure while achieving long life. Recent national research aided by information and support from WSDOT has provided additional understanding and design aids for achieving long-lasting designs which incorporate the existing (or modified) pavement structure. The national research produced “rePave” which is used by WSDOT for selecting rehabilitation strategies.

## **2.6 PAVEMENT PRESERVATION**

WSDOT uses principles associated with pavement preservation to manage the state highway system. The preservation cycle begins immediately after construction since the effects of traffic, climate, and traction devices will deteriorate pavement structures. Preservation starts with how a new or reconstructed pavement structure is designed and constructed and continues through the complete life-cycle.



### **3. PAVEMENT DESIGN CONSIDERATIONS**

#### **3.1 DESIGN PERIOD**

The design period is the time from original construction to a terminal condition for a pavement structure. The American Association of State Highway and Transportation Officials (AASHTO) essentially defines design period, design life and performance period as being the same terms. AASHTO defines an analysis period as the time for which an economic analysis is to be conducted. Further, the analysis period can include provisions for periodic surface renewal or rehabilitation strategies which will extend the overall service life of a pavement structure before complete reconstruction is required.

The design period used by WSDOT is chosen so that the design period traffic will result in a pavement structure sufficient to survive through the analysis period. It is recognized that intermittent treatments will be needed to preserve the surface quality and ensure that the structure lasts through the analysis period. The required design period for all WSDOT highways is 50 years.

The 50-year design period can be reduced for unique, project specific conditions such as temporary pavement sections, HOV lanes, future realignment or grade changes.

Doubling the design period equivalent single axle loads (ESALs) adds about 0.5 to 1.0 inches of HMA or PCCP to the required initial structural thickness of a HMA or PCCP design. As such, modest increases in pavement thickness can accommodate significantly increased traffic as characterized by ESALs.

#### **3.2 TRAFFIC**

The volume and character of traffic, expressed in terms of 18,000 lb. ESALs, is a measure of the traffic loading experienced by a pavement. The ESAL loading on a highway strongly influences pavement structural design requirements. Both HMA and PCCP pavement structures can be designed to meet any ESAL requirement; however, this does not imply similar maintenance and rehabilitation requirements.

### 3.3 SUBGRADE SOILS

The characteristics of native soils directly affect the pavement structure design. A careful evaluation of soil characteristics is a basic requirement for each individual pavement structure design. Subgrade resilient modulus is the primary material input into the *AASHTO Guide for Design of Pavement Structures* (1993).

### 3.4 FROST ACTION

Greater depths of base or selected free-draining borrow materials are necessary in areas where frost action is severe or the subgrade soil is extremely weak. The total depth of the pavement structure is extremely important in high frost penetration areas. Additional thickness of non-frost susceptible base or subbase materials has been effectively used to combat this problem. An effective measure is to have the pavement structure (total of surface and base courses) equal to at least one-half the maximum expected depth of freeze when the subgrade is classified as a frost susceptible soil. The depth of freeze is based on the design freezing index (30 year temperature record) or measurements made by WSDOT during the severe winter of 1949-1950 (Appendix 2). The winter of 1949-1950 produced the greatest depth of freeze during the past 70 years.

### 3.5 DESIGN RESOURCES

WSDOT uses a range of tools and information to help assess, scope, and design pavement structures. Some of the design resources include the following:

- Washington State Pavement Management System (WSPMS)
- [Pavement Interactive \(https://www.pavementinteractive.org/\)](https://www.pavementinteractive.org/): A resource with basic pavement-oriented content along with links to numerous pavement application programs. The PI was originally developed with the support of the several state DOTs (including WSDOT) and the Federal Highway Administration (FHWA).
- Everseries software: A PC based pavement analysis tools which includes Everstress (general layered elastic analysis tool), Evercalc (backcalculate pavement layer moduli from FWD deflection basins), and Everpave (HMA overlay design for flexible pavements).
- AASHTO Guide for Design of Pavement Structures (1993): This guide is used to design HMA and PCCP.

## WSDOT Pavement Policy

- [PaveXpress \(https://www.pavexpressdesign.com/\)](https://www.pavexpressdesign.com/): A web based online tool for designing new and reconstructed HMA and PCCP by the AASHTO 1993/1998 processes.
- [rePave \(http://www.pavementrenewal.org/\)](http://www.pavementrenewal.org/): A web based online process to scope long-lasting pavements which incorporate the existing pavement structure. This tool is a result from the SHRP2 R23 study “Using Existing Pavement in Place and Achieving Long Life.”
- [Rapid Road Rehabilitation \(https://rapidroadrehab.headlight.paviasystems.com/\)](https://rapidroadrehab.headlight.paviasystems.com/): Web based software tool used to analyze highway pavement rehabilitation strategies including productivity, project scheduling, traffic impacts, and initial project costs.
- [RealCost \(https://www.fhwa.dot.gov/infrastructure/asstmgmt/lccasoft.cfm\)](https://www.fhwa.dot.gov/infrastructure/asstmgmt/lccasoft.cfm): Engineering economic tool developed by FHWA which uses life cycle cost assessment to compare economic investments for new construction, reconstruction, rehabilitation and maintenance projects. Initial construction and discounted future rehabilitation(s), maintenance, and user costs are factored in the analysis along with salvage value.

As design tools continue to evolve, WSDOT will review and adopt if judged as improved procedures (or software).





## 4. PAVEMENT TYPE SELECTION

There are three primary areas that must be addressed to select a pavement type: pavement design analysis, life cycle cost analysis, and project specific details. Each of these areas can have a significant impact on the selected pavement type and requires a detailed analysis. The overall process is shown in Figure 4.1. The specific requirements for each step and examples are included in Appendix 3 through 8.

Pavement type selection is applicable to all new alignments including ramps, roundabouts, collector-distributors, acceleration-deceleration lanes, and existing pavement reconstruction on interstate, principal arterials, and any other roadway that may benefit from this analysis. Pavement type selection is not necessary for chip seal surfaced roadways. For mainline widening, if the selected pavement type is the same pavement type as the existing, then a pavement type selection is not required. When comparing life cycle costs of the different alternatives, the comparison must be based on the total costs, which include initial construction, maintenance, rehabilitation, and user costs.

Pavement types shall be considered equal if the total cost difference (including all the costs listed above) for the higher cost alternative does not exceed the lower cost alternative by more than 10 percent. Otherwise, the lower cost alternative shall be selected.

### 4.1 APPLICATION OF PAVEMENT TYPE SELECTION

The following is a list of considerations for new construction or reconstruction of mainline, ramps, collector-distributors, roundabouts, acceleration-deceleration lanes, intersections and shoulders.

- **Mainline new and reconstructed:** A pavement type selection must be completed on all mainline pavements that are more than 1 lane mile in length or pavement cost more than \$1.0 million except those highways designated as having or is planned to have a chip seal surface. For roadway segments shorter in length or lower in cost, Contact the State Pavement Office for further direction on the need to conduct a pavement type selection.
- **Ramps:** Both PCCP and HMA shall be considered for ramps with mature geometrics (where lane configuration or right of way restricts the expansion of the roadway footprint), high traffic and high truck percentages.

- **Collector-Distributors:** Design collector-distributors similar to ramps above.
- **Roundabouts:** Construct roundabouts with the same pavement type as the intersecting roadway. If the proposed pavement type is different from the mainline pavement type a life cycle cost justification is required.
- **Acceleration-Deceleration Lanes:** Treat the same as collector-distributors.
- **Intersections:** Most intersections will not require an analysis separate from the rest of the highway. Intersections with chronic rutting should be examined in detail to determine the nature and cause of the rutting and whether alternate pavement types should be considered. Contact the State Pavement Office for further guidance and direction regarding options for addressing chronic intersection rutting.
- **Shoulders:** The choice of HMA or PCCP shoulders for new PCCP is dependent upon the future use of the roadway structure. When evaluating the use of PCCP shoulders the initial capitalization costs must be considered in addition to the life-cycle cost. Any increase in initial cost for PCCP shoulders must be approved by the State Pavement Office. Future traffic in this context implies either diverted traffic, construction or the shoulder will become a primary lane of traffic at a future date.
  - **Shoulders Will Not be used for Future Traffic:** Shoulders for this application are designed as HMA pavement.
  - **Shoulders will be used for Future Traffic:** Shoulders for this application may be designed as HMA or PCCP. Design PCCP shoulders to be used for future traffic the full width of the future lane and for the anticipated ESALs. Construct PCCP shoulders for future traffic with HMA base, tie bars and dowels.
  - **Urban Roadways:** It is recommended that shoulders be constructed with the same section used for mainline PCCP including HMA base, tie bars and dowels.

#### 4.2 SUBMITTAL PROCESS

The pavement type selection, including all applicable subsections (pavement design analysis, cost estimate and life cycle cost analysis, including the results of the RealCost evaluation including all applicable RealCost input files and project specific details shall be submitted electronically to the Pavement Design Engineer at the State Pavement Office. The pavement type selection analysis shall be reviewed and distributed to the Pavement Type Selection Committee (Appendix 3 through 7) for approval. The report submittal shall include detailed

explanation of the various applicable items, as those outlined above, that supports the selection of the recommended pavement type.

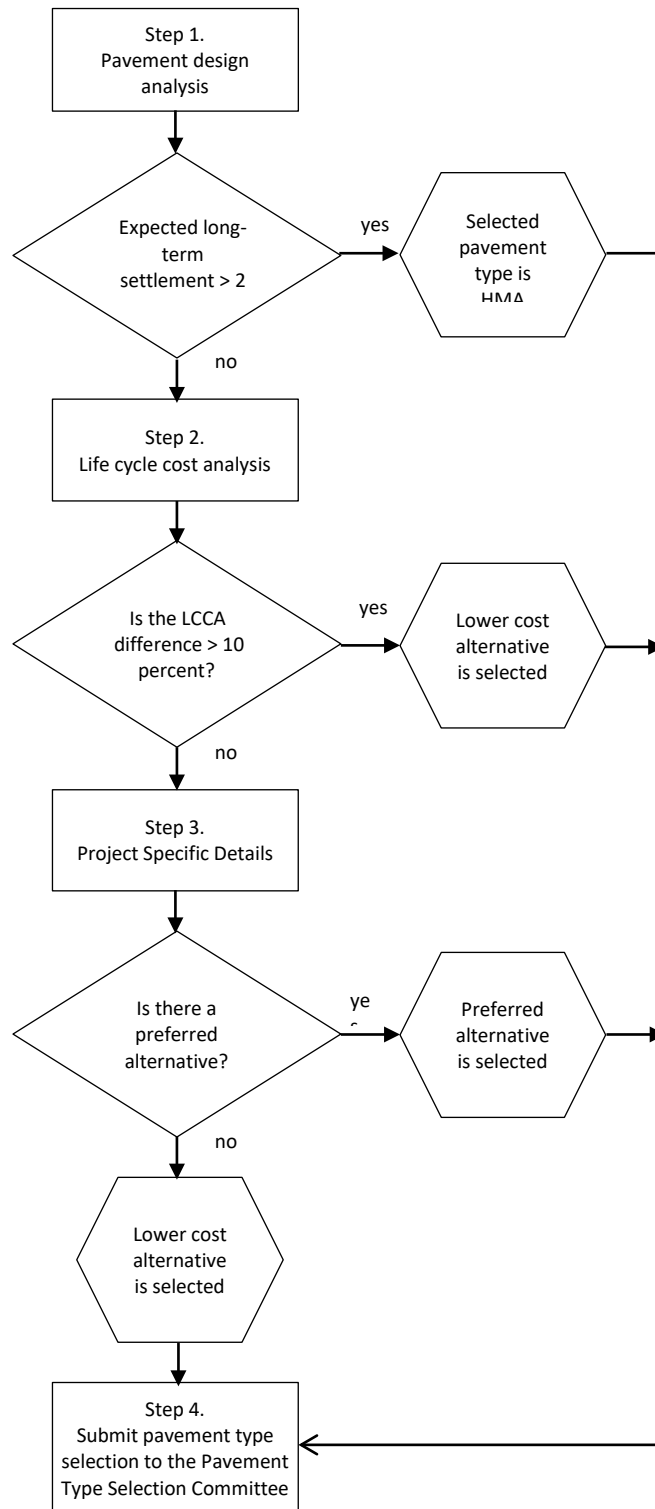

**Figure 4.1. Pavement Type Selection Flow Chart**



## **5. NEW PAVEMENT DESIGN**

### **5.1 DESIGN PROCEDURES**

"New pavement design" shall include reconstructed as well as new pavement structures.

The primary design procedure for pavement structures is the AASHTO Guide for Design of Pavement Structures (1993); however, the Mechanistic-Empirical Pavement Design Guide (MEPDG version 1.0) along with WSDOT pavement historical data and experience was used in the development and validation of the design tables. Minimum layer thicknesses are controlled by requirements contained in Section 8.2.3. Requirements for maximum lift thicknesses are specified within WSDOT's Standard Specifications for Road, Bridge, and Municipal Construction (which also describes other pavement material requirements such as gradation, fracture, cleanliness, etc.).

### **5.2 DETERMINATION OF FLEXIBLE PAVEMENT LAYER THICKNESSES**

#### **5.2.1 INTRODUCTION**

Layer thicknesses and total pavement structure over subgrade soils for HMA pavements are based on four criteria:

- Depth to provide a minimum level of serviceability for the design period recognizing that periodic surface renewals may be needed,
- Depth to prevent excessive rutting,
- Depth to prevent premature fatigue cracking of the HMA layers, and
- Depth to provide adequate frost depth protection.

#### **5.2.2 MAINLINE ROADWAY**

The structural design of mainline flexible pavements can be broadly divided into those with fewer than 1,000,000 ESALs for the design period and those greater than 1,000,000 ESALs. Those pavements with AADT less than 10,000 shall be considered for a chip seal wearing course over CSBC. For pavements with ESALs less than 1,000,000 and ADT levels greater than 10,000 both chip seal and HMA surfaces shall be considered. Table 5.1 provides typical layer thicknesses for HMA surfaced flexible pavements for ESAL levels up to 200 million. The HMA structural design

thicknesses provided in Table 5.1 assume a subgrade modulus of 10,000 psi which is typical of most WSDOT roadways. Table 5.1 also shows PCCP slab and base thicknesses for convenience (see Section 5.3 for specifics about PCCP design). HMA structural designs other than those shown in Table 5.1 can be used, if justified, by use of job specific input values in the AASHTO Guide for Design of Pavement Structures (1993). Table 5.2 provides commentary about the assumptions and input values used to develop Table 5.1. Input values different than those in Table 5.2 must be approved by the State Pavement Office.

Table 5.3 provides typical layer thicknesses for flexible pavements with design ESAL levels of 1,000,000 or less. The chip seal surface course is considered the most economical choice for low ESAL pavements.

**Table 5.1. Layer Thicknesses for New or Reconstructed Pavements**

Design Period ESALs	Layer Thicknesses, ft.				
	HMA Pavement		PCCP		
	HMA	CSBC Base	PCCP Slab	Base Type and Thickness	
< 5,000,000	0.50	0.50	0.67	CSBC only	0.35
5,000,000 to 10,000,000	0.67	0.50	0.75	HMA over CSBC	0.35 + 0.35
10,000,000 to 25,000,000	0.83	0.50	0.83	HMA over CSBC	0.35 + 0.35
25,000,000 to 50,000,000	0.92	0.58	0.92	HMA over CSBC	0.35 + 0.35
50,000,000 to 100,000,000	1.00	0.67	1.00	HMA over CSBC	0.35 + 0.35
100,000,000 to 200,000,000	1.08	0.75	1.08	HMA over CSBC	0.35 + 0.35

**Table 5.2. Commentary for Pavement Design Assumptions and Inputs for Table 5.1.**

<p><b>Design Procedures:</b> Two design procedures were used to develop Table 5.1 along with results from national and international studies. The primary procedure used was the AASHTO Guide for Design of Pavement Structures (1993). The secondary procedure was the MEPDG (version 1.0).</p>
<p><b>HMA Pavement Assumptions:</b> The thicknesses shown in Table 5.1 are a combination of results largely from AASHTO 93. The results were modified as needed with additional information from the MEPDG 1.0, WSDOT historical pavement performance data and experience. The assumptions used in AASHTO 93 for HMA pavement design included: <math>\Delta PSI = 1.5</math>, <math>S_o = 0.5</math>, <math>m = 1.0</math>, <math>a_{HMA} = 0.50</math>, <math>a_{CSBC} = 0.13</math>, <math>M_R = 10,000</math> psi, and <math>E_{base} = 30,000</math> psi. Thicker CSBC layers may be required for frost design.</p>
<p><b>PCCP Assumptions:</b> The thicknesses shown in Table 5.1 are a combination of results largely from AASHTO 93. The results were modified as needed with additional information from MEPDG 1.0, WSDOT historical pavement performance data and experience. The assumptions used in AASHTO 93 for PCCP design included: <math>J = 3.2</math> (dowels), <math>S_o = 0.4</math>, <math>E_c = 4,000,000</math> psi, <math>C_d = 1.0</math>, <math>\Delta PSI = 1.5</math>, <math>S_c = 700</math>psi, <math>k = 200</math> pci (if CSBC is the only base layer), <math>k = 400</math> pci (HMA base paved over CSBC).</p>
<p><b>Base Layers for PCCP:</b> For ESAL levels less than 5,000,000, it is assumed PCCP slabs will be placed on CSBC. For higher ESAL levels, PCCP slabs will be placed on HMA base (0.35 ft. thick) over CSBC base (minimum of 0.35 ft. thick). Thicker CSBC layers may be required for frost design.</p>
<p><b>Subgrade Modulus for HMA Pavements:</b> For HMA pavements, a subgrade resilient modulus of 10,000 psi was used. This is a reasonable assumption based on prior laboratory and field tests statewide. Higher subgrade moduli can be achieved but generally only with granular, low fines materials or some type of subgrade stabilization. It is critical that all WSDOT pavement structures be constructed on well-designed and constructed subgrades.</p>
<p><b>Reliability Levels:</b> A reliability level of 85% was used in AASHTO 93 for ESAL levels of less than 10,000,000. A reliability level of 95% was used for ESAL levels of 10,000,000 and higher.</p>
<p><b>Other Observations:</b></p> <ul style="list-style-type: none"> <li>• ESAL levels: For the ESAL levels in Table 5.1, the difference in HMA and PCCP layer thicknesses are about 1.0 inch for each doubling of ESAL level.</li> <li>• By constructing or reconstructing HMA pavements on a stiffer subgrade (greater than 10,000 psi), reductions in the total HMA thickness can be made; however, this must be done by use of the approved design method (AASHTO 93).</li> <li>• Typically, surface renewal techniques for HMA pavements involves: (1) adding HMA thickness, or (2) planing/milling the existing surface course and replacing with an equal thickness of HMA. PCCP surface renewal involves diamond grinding which permanently reduces the PCCP slab thickness.</li> </ul>

**Table 5.3. Pavement Layer Thicknesses for Low ESAL Levels and New or Reconstructed Pavements— Chip Seal Surfaced**

Design Period ESALs	Subgrade Condition	Required SN	Layer Thicknesses, <sup>1</sup> ft.	
			Reliability = 75%	
			Chip Seal <sup>3</sup>	CSBC <sup>2</sup>
< 100,000	Poor	2.53	0.08	1.50
	Average	1.93	0.08	1.10
	Good	1.45	0.08	0.90 <sup>4</sup>
100,000-250,000	Poor	2.95	0.08	1.80
	Average	2.25	0.08	1.30
	Good	1.71	0.08	1.00
250,000-500,000	Poor	3.31	0.08	2.00
	Average	2.53	0.08	1.50
	Good	1.93	0.08	1.10
500,000-1,000,000	Poor	3.77	0.08	2.30
	Average	2.86	0.08	1.70
	Good	2.17	0.08	1.25

<sup>1</sup>AASHTO Guide for Design of Pavement Structures (1993) for flexible pavements and the following inputs:

- $\Delta PSI = 1.7$
- $S_0 = 0.50$
- $m = 1.0$
- $a_{chip\ seal} = 0.20$  (assumes  $E_{chip\ seal} = 100,000$  psi)
- $a_{CSBC} = 0.13$
- $SN = a_{chip\ seal} (1") + a_{CSBC} (CSBC)$
- Subgrade Condition (effective modulus)
  - Poor:  $M_R = 5,000$  psi
  - Average:  $M_R = 10,000$  psi
  - Good:  $M_R = 20,000$  psi
 (Note: Effective modulus represents the subgrade modulus adjusted for seasonal variation)

<sup>2</sup>Gravel base may be substituted for a portion of CSBC when the required thickness of CSBC  $\geq 0.70$  ft. The minimum thickness of CSBC is 0.35 ft. when such a substitution is made.

<sup>3</sup>Newly constructed chip seal assumed thickness = 0.08 ft.

<sup>4</sup>CSBC thickness increased for a total pavement structure of approximately 1.00 ft. based on moisture and frost conditions.



### 5.2.3 RAMPS, FRONTAGE ROADS, AND WEIGH STATIONS

Ramps shall be designed for the expected traffic.

Frontage roads and weigh stations that are maintained by WSDOT shall be designed in accordance with the AASHTO Guide for Design of Pavement Structures (1993). Frontage roads that counties and cities are to accept and maintain but constructed by WSDOT shall be designed to the standards of the accepting agency.

The total depth of the pavement section must be at least one-half of the maximum expected depth of freezing when the subgrade is classified as a frost susceptible soil. The depth of expected freeze can be based on calculations by use of the design freezing index or the field data gathered by WSDOT during the winter of 1949-1950 (see Appendix 2).

### 5.2.4 REST AREAS

The minimum HMA pavement requirements for rest area roadways and parking areas are:

**Table 5.4 HMA Pavement Thickness Requirements for Rest Areas**

<ul style="list-style-type: none"> <li>• Access Roads and Truck Parking</li> </ul>	0.50 ft. HMA 0.50 ft. CSBC
<ul style="list-style-type: none"> <li>• Car Parking</li> </ul>	0.35 ft. HMA 0.50 ft. CSBC

Project specific traffic and subgrade soil conditions may require thicker pavement layers. Such designs shall be done in accordance with the AASHTO Guide for Design of Pavement Structures (1993). The total depth of the pavement section must be at least one-half of the maximum expected depth of freezing when the subgrade is classified as a frost susceptible soil.

### 5.2.5 SHOULDERS

The requirements for HMA pavement shoulders are:

**Table 5.5 HMA Pavement Thickness Requirements for Shoulders**

<ul style="list-style-type: none"> <li>• Interstate</li> </ul>	0.35 ft. HMA (0.50 ft. HMA for truck chain-up areas) 0.35 ft. CSBC Variable depth of additional base*
<ul style="list-style-type: none"> <li>• Non-Interstate</li> </ul>	0.25 ft. HMA (0.50 ft. HMA for truck chain-up areas) 0.35 ft. CSBC Variable depth of additional base*

\* The Gravel Base or CSBC shall extend to the bottom of the mainline base course.

Design HMA shoulder pavement thickness the same as the travelled way in the following locations:

- Ramps
- Intersections where turning movements will result in vehicles tracking on the shoulders
- Areas designated for shoulder driving
- Slow vehicle turnouts
- WSP Shoulder weighing/inspection sites

The mainline full-depth pavement section may be extended 0.5 to 1.0 feet into the shoulder to provide structure to support off-tracking vehicles.

Pavement thicknesses different than described above require approval by the State Pavement Office.

The total depth of the pavement section must be at least one-half of the maximum expected depth of freezing when the subgrade is classified as a frost susceptible soil.

### **5.3 DETERMINATION OF RIGID PAVEMENT LAYER THICKNESSES**

The principal type of PCCP used by WSDOT in the past, and will be continued for the foreseeable future, is a plain, jointed PCCP with dowel bars.

All new construction, reconstruction and lane widening shall be conducted such that the PCCP lane edges and the lane stripe are congruent, except when the outside lane is paved 14 feet in width in which case the lane shall be striped at 12 feet (see 8.3.1).

#### **5.3.1 INTRODUCTION**

Based on the past performance of PCCP on the state route system under a variety of traffic conditions (various ESAL levels) and on city streets (such as the City of Seattle), it is advisable to use slab thicknesses of 0.67 feet or greater even if the ESAL levels would suggest that lesser slab thicknesses would be adequate. A slab thickness of 0.67 feet or greater provides some assurance of adequate long-term performance given that other design details are adequately accommodated.

**5.3.2 MAINLINE ROADWAY**

Table 5.1 provides layer thicknesses for PCCP for ESAL levels up to 200 million. The PCCP thicknesses included in Table 5.1 are supported on granular or HMA base depending upon the ESAL level. Table 5.2 provides commentary about the assumptions and input values used to develop the PCCP layer thicknesses.

PCCP slab thicknesses other than those shown in Table 5.1 can be used if justified by project specific input values used in the AASHTO Guide for Design of Pavement Structures (1993). Table 5.2 provides commentary about the assumptions and input values used to develop Table 5.1. Input values different than those in Table 5.2 must be approved by the State Pavement Office.

The total depth of the pavement section must be at least one-half of the maximum expected depth of freezing when the subgrade is classified as a frost susceptible soil.

**5.3.3 PCCP INTERSECTIONS AND ROUNDABOUTS**

The same requirements apply as described in paragraph 5.3.2. Jointing details, PCCP construction limits and specifics concerning roundabout construction requires approval by the State Pavement Office.

**5.3.4 RAMPS, FRONTAGE ROADS, AND WEIGH STATIONS**

The same requirements apply to PCCP ramps and frontage roads as for HMA pavements as noted in Paragraph 5.2.3.

**5.3.5 REST AREAS**

The minimum PCCP requirements for rest area roadways and parking areas are:

**Table 5.6 PCCP Thickness Requirements for Rest Areas**

• Access Roads	0.75 ft. PCCP (doweled) 0.35 ft. CSBC
• Truck Parking	0.67 ft. PCCP (undoweled) 0.35 ft. CSBC
• Car Parking	0.67 ft. PCCP (undoweled) 0.35 ft. CSBC

Project specific traffic and subgrade soil conditions may require thicker pavement layers. Such designs shall be done in accordance with the AASHTO Guide for Design of Pavement Structures (1993).

The total depth of the pavement section must be at least one-half of the maximum expected depth of freeze when the subgrade is classified as a frost susceptible soil.

### **5.3.6 SHOULDERS**

When shoulders will not be used for future traffic, the PCCP shoulder pavement section must match the mainline thickness and be placed over granular base.

Shoulders that will carry future traffic are designed as full depth HMA or PCCP, built to match the mainline traffic lanes. These shoulders are constructed using the same full depth section as the mainline, with lane widths following the Design Manual requirements.

## **5.4 PERMEABLE PAVEMENTS**

Conventional impermeable pavement does not allow water to penetrate into the ground where it can be naturally filtered and cleaned before entering streams and underground water supplies. Permeable pavements are a method of managing stormwater that eliminates the need of a separate collection, treatment and storage system. Water simply flows through the permeable pavement and directly into the underlying soil.

### **5.4.1 INTRODUCTION**

Permeable pavement suits new construction of very low volume, slow speed locations with infrequent truck traffic.

### **5.4.2 APPLICATION**

Permeable pavements shall be considered and used for the following applications:

- Sidewalks, bicycle trails, community trail/pedestrian path systems, or any pedestrian-accessible paved areas (such as traffic islands)
- Light vehicle access areas such as maintenance/enforcement areas on divided highways
- Public and municipal parking lots, including perimeter and overflow parking areas
- Driveways

**5.4.3 PAVEMENT STRUCTURE**

Permeable pavements include an engineered structure consisting of permeable hot mix asphalt or concrete wearing surface, aggregate storage layer and a subgrade soil with sufficient infiltration capability to drain water from the aggregate storage layer.

**5.4.4 PAVEMENT DESIGN REQUIREMENTS**

The minimum pavement thickness requirements for permeable pavement applications are:

**Table 5.7 Thickness Requirements for Permeable Pavement**

<b>Facility</b>	<b>HMA</b>	<b>PCCP</b>
<ul style="list-style-type: none"> <li>Light Vehicle Access Areas</li> </ul>	0.50 ft. Permeable HMA 0.50 ft. (permeable base)	0.75 ft. Undoweled Permeable PCCP 0.50 ft. (permeable base)
<ul style="list-style-type: none"> <li>Truck Parking</li> </ul>	0.50 ft. Permeable HMA 0.50 ft. (permeable base)	0.75 ft. Undoweled Permeable PCCP 0.50 ft. (permeable base)
<ul style="list-style-type: none"> <li>Car Parking</li> </ul>	0.35 ft. Permeable HMA 0.50 ft. (permeable base)	0.67 ft. Undoweled Permeable PCCP 0.50 ft. (permeable base)
<ul style="list-style-type: none"> <li>Pedestrian Sidewalks and Trails</li> </ul>	0.25 ft. Permeable HMA 0.35 ft. (permeable base)	0.35 ft. Undoweled Permeable PCCP 0.35 ft. (permeable base)

**5.4.5 PERMEABLE BASE STORAGE LAYER**

The permeable base storage layer thicknesses shown above are based on the minimum structural needs of the permeable pavement application. Reference the WSDOT Highway Runoff Manual to determine the thicknesses based on subgrade infiltration and the pavement storage capacity needs. In some cases, additional permeable base thickness may be required for frost design purposes. Permeable base aggregate shall consist of permeable ballast. Alternate gradations require State Pavement Office approval.



## **6. PAVEMENT REHABILITATION**

If a pavement section reaches a point where preservation is no longer cost effective, rehabilitation will be required to restore its structural capacity. Employing a rehabilitation strategy that takes advantage of the remaining structure in the existing pavement is usually more economical than reconstruction. Rehabilitation methods detailed below that re-use the remaining structure of the existing pavement should be considered before reconstructing a pavement. A life cycle cost analysis of the viable alternatives is required to determine if one of these methods or reconstruction is the best option. Alternatives other than those listed here may also be considered with the approval of the State Pavement Office. Use a 50-year design life for design of rehabilitations.

National guidelines have been developed (with help from WSDOT) for designing long-lasting structural enhancements that incorporate existing pavements. These guidelines are available in a final report on SHRP2 Project R23 and through a web-based program called rePave. It is recommended that rePave be used for preliminary project scoping. The final structural design shall be in coordination with and approved by the State Pavement Office.

A summary of the applicability of the rehabilitation methods is shown in Table 6.1

### **6.1 COLD IN-PLACE RECYCLING**

Cold in-place recycling (CIR) is a mobile non-heating mechanical process that recycles an existing pavement in place by removing a specified depth of HMA surfacing, pulverizing the bituminous material, mixing in measured amounts of emulsified liquid asphalt and lime slurry, paving and compacting the recycled material back on the roadway. Following the CIR processing the surface is overlaid with an HMA or chip seal wearing surface.

CIR is best suited to the lower traffic levels and dryer conditions of rural highways in Eastern Washington. To cure, CIR needs dry conditions making it unsuitable to the wetter climate on west side of the state. The process also requires lengthy work zones using piloted traffic making it less suitable to higher volume roadways or urban environments. CIR can be used to recycle to a depth of 4 inches but the composition of the existing pavement needs to be relatively consistent

to avoid difficulties in controlling the emulsion rates. Because CIR is only able to recycle the surface layers, it is not able to correct deep failures or subgrade problems. Ideal candidates for CIR are pavements showing distresses from transverse, reflective, or fatigue cracking, oxidation and raveling within the HMA or HMA/Chip Seal composite layer.

**Table 6.1 Applicability of Rehabilitation Methods**

<b>Treatment Option</b>	<b>Candidate Pavement</b>	<b>Distresses Corrected</b>	<b>Traffic Limitations</b>	<b>Other Limitations</b>
Cold In-Place Recycling	Chip Seal and HMA less than 0.50 feet combined thickness without extensive base and subgrade problems	Cracking, ravelling, oxidization, rutting	Requires extended lane closure and pilot car operation	Requires dry conditions to cure, up to 4 inches can be recycled
Full Depth Reclamation	Bituminous pavements less than 1.0 foot total thickness with full depth failures	Corrects most distresses except for subgrade problems	Lane/road closures, limited traffic can drive on FDR prior to paving	Requires investigation of existing material, subgrade must be able to support FDR equipment
Crack, Seal and Overlay	Cracked faulted and rough PCCP, panels must be stable and not shattered, base and subgrade must be in good condition	Cracking, faulting, studded tire wear	Traffic may be allowed on cracked PCCP after removing loose material and filling voids	Unstable and shattered panels require repair prior to overlay, increases roadway elevation
Unbonded PCCP Overlay	Distressed PCCP or HMA that does not have extensive full depth failures	All types of distress in the existing HMA or PCCP	Requires extended closures.	Unstable areas must be corrected, increases roadway elevation. Requires HMA bond breaker on existing PCCP.
Structural HMA Overlay	HMA pavements where preservation treatments are no longer cost effective but underlying layers have remaining structure	Surface distresses, top down cracking, rutting, ravelling	Lane closures	Lower lifts must be structurally sound

In CIR design, it is desirable to recycle the full depth of the bituminous layers to ensure that any cracking is eliminated but the base and subgrade must be adequate to support the CIR equipment. If full depth removal is not possible, at least two thirds of the bituminous layers should be recycled to prevent any full depth cracks from reflecting into the CIR. Typically, 1.5 inches of remaining bituminous material is sufficient to support the CIR train. Core the existing pavement to ensure that the existing pavement depth is sufficient.



The new pavement structure can be designed using AASHTO Guide for Design of Pavement Structures (1993) using a 0.40 layer coefficient for the CIR. A reduced structural coefficient should also be used for any bituminous layer and base remaining after recycling. The HMA layer placed over CIR typically ranges from 0.15 to 0.25 feet although thicker sections may be necessary for higher truck traffic. At a minimum, a chip seal with two applications of emulsion and aggregate should be placed over the CIR to prevent ravelling.

## **6.2 FULL DEPTH RECLAMATION**

Full Depth Reclamation (FDR) is a rehabilitation method where the full depth of the existing bound pavement layers are pulverized and mixed in with the base and subgrade. Stabilization agents may be added to increase the strength of the reclaimed mixture as well as additional aggregate as needed. FDR is capable of reclaiming the existing pavement structure up to a depth of one foot in a single pass but the total bituminous layer depth needs to be at least one inch less than the total reclaimed depth to allow the reclaimer to operate effectively.

Although a limited amount of traffic can be allowed on FDR prior to paving, FDR is most appropriate to roadways where longer closures can be accommodated. Since the full depth of the pavement layer is reclaimed, FDR is appropriate to repair any distress other than subgrade problems.

Many different materials have been used as stabilizing agents with asphalt emulsions and portland cement the most common. FDR requires the sampling of materials from the roadway to determine moisture content and test trial mixtures in the lab in order to determine a suitable application rate for the stabilizing agents. In pavement design, a structural coefficient of 0.20 is typically used with the AASHTO Guide for Design of Pavement Structures (1993).

## **6.3 CRACK, SEAT AND OVERLAY**

Cracking and seating existing PCCP reduces the effective panel size from WSDOT's standard 12 feet by 15 feet panel to fully cracked segments of pavement between 2 and 6 feet on a side with the general goal that the segments are approximately square. The smaller effective panel size distributes tensile stresses over more joints reducing the strain and resulting reflection cracking in an HMA overlay. Crack, seat and overlay is applicable to PCCP that has reached the end of its useful life and pavement preservation techniques are no longer cost effective. The crack and seat process requires a subgrade that is in relatively good condition and there should not be a

large number of panels that have settled or are shattered. Settled or shattered panels need to be replaced with HMA prior to overlaying.

To insure long pavement life, the minimum overlay thickness should be 0.65 feet of HMA. Thicker overlays may be designed depending on traffic loading, subgrade and site conditions. The overlay can be designed using AASHTO Guide for Design of Pavement Structures (1993). A modulus of 75,000 psi is recommended for the crack and seated PCCP (rePave, 2015). Crack, seat and overlay will increase the roadway grade by the thickness of the overlay. Undercrossings with insufficient vertical clearance and mainline bridges will require removal of the existing PCCP and replacement with new full depth HMA pavement sections to maintain the required grade.

#### **6.4 UNBONDED PCCP OVERLAY**

An unbonded PCCP overlay consists of a new PCCP placed over an existing HMA or PCCP pavement. By using the remaining structure of the existing HMA or PCCP, the thickness of the new PCCP overlay can be designed thinner than if it was a new pavement section. If the existing pavement is PCCP, a separation layer needs to be placed between the old and new pavement. The separation layer isolates the new PCCP overlay from the existing pavement allowing the unbonded overlay to be placed over existing pavement that is in poor condition. Only unstable areas of the existing pavement need to be repaired prior to the overlay.

The thickness of an unbonded overlay may be designed using AASHTO Guide for Design of Pavement Structures (1993). Adjustments should be made to the resulting PCCP thicknesses to account for the conservatively thick sections generated by AASHTO Guide for Design of Pavement Structures (1993). This can be done by adjusting the resulting thickness generated by AASHTO Guide for Design of Pavement Structures (1993) to a thickness that is in proportion to Table 5.1.

An unbonded overlay will increase the roadway elevation by the thickness of the overlay and the separation layer. Undercrossings with insufficient vertical clearance and mainline bridges will require removal of the existing pavement and replacement new full depth pavement sections to maintain the required grade.

## **6.5 HMA STRUCTURAL OVERLAY**

An HMA structural overlay may be considered when pavement preservation treatments are no longer a cost effective alternative to preserve the pavement until the next rehabilitation period. Structural overlays should only be used where past pavement performance has shown that the pavement structure is insufficient. Pavement that is performing adequately should not receive a structural overlay simply because an analysis shows that the structure is not sufficient for the future ESALs. Pavements that have little or no remaining structure are not good candidates for a structural overlay and another treatment should be considered.

Thickness design of structural overlays should be performed using AASHTO Guide for Design of Pavement Structures (1993) by applying a reduced structural value for existing layers that are to remain or by using overlay design procedure in the AASHTO Guide. Prior to constructing the overlay, structural distresses in the existing pavement need to be repaired. This may include milling to remove top down cracking or pavement repair to fix deeper structural problems.



## **7. PAVEMENT PRESERVATION**

Pavement preservation extends the service life of an existing pavement. The pavement preservation strategy selected should extend the pavement service life at the lowest life cycle cost.

The pavement preservation strategy selected depends on the type of pavement (chip seal, HMA or PCCP) and the pavement condition. Roadways with annual average daily traffic (AADT) less than 10,000 are designated chip seal routes and preservation of these routes should follow Section 7.1 Chip Seals. Exceptions (such as paving through urban areas, intersections with a significant number of turning movements, locations with limited chip seal use, etc.) to this policy are evaluated on a case-by-case basis. The AADT criterion of 10,000 does not imply that chip seals cannot or should not be placed on higher AADT routes. If the Region requests placing a chip seal on a higher volume HMA route, the request shall be made based on a pavement analysis and documented in the Regions Pavement Design Report. HMA and PCCP routes will be preserved with the same pavement type as the existing pavement. Approval for application of chip seals on routes with AADT greater than 10,000 and other exceptions requires approval from the State Pavement Engineer.

The primary method of preserving HMA routes is a thin HMA inlay or overlay. Preservation treatments such as crack sealing, patching and chip sealing should be used to extend the time between thin inlays/overlays on all HMA routes.

### **7.1 CHIP SEALS**

Chip seals are an effective method of preserving pavements on low volume roadways at a low life cycle cost. In order to realize the low life cycle cost of a chip seal, work performed to correct deficiencies in the existing pavement needs to be kept to the minimum required to provide serviceable pavement over the life of the chip seal.

### **7.1.1 PAVEMENT DESIGN**

The design period for a chip seal is typically six to eight years. Regions may use any design method that gives acceptable results. Chip seal types other than those provided in Section 5-02 of the Standard Specifications must be approved through the State Pavement Office.

### **7.1.2 PREPARATION OF EXISTING PAVEMENT**

Deficiencies in the existing pavement that may affect the performance of the chip seal will need to be corrected prior to placing the chip seal. Corrective work should be limited to that necessary to preserve the roadway and provide a serviceable pavement for the life of the chip seal.

#### *7.1.2.1 Prelevel*

The use of prelevel prior to placement of a chip seal is limited strictly to spot improvements such as broken shoulders or distressed pavement and is limited to 70 tons of HMA per lane mile. Increased prelevel quantities require approval by the State Pavement Office. Reasons for the increased prelevel quantities include:

1. Removal of hazardous “spot” locations, e.g., ponding areas or to restore proper pavement drainage at a specific location.
2. Correction of deficient superelevation or cross slope when the deficiency is the cause of operational problems as determined from an accident history analysis.
3. Pavement rutting specifically identified (rutting greater than  $\frac{3}{8}$  inch).

When any prelevel is warranted it must be clearly documented in the pavement design and carefully detailed in the contract PS&E so that the use is clearly apparent to the contractor and the construction Project Engineer.

#### *7.1.2.2 Pavement Repair*

Pavement repair on chip seal projects should address areas of load related failure of the existing pavement such as depressed alligator cracked areas. Pavement repair depth should be kept to the minimum required to restore the load carrying capacity of the pavement.

#### *7.1.2.3 Crack Sealing*

Chip seal performance can be enhanced by sealing cracks prior to the chip seal application. Where hot poured crack sealing products have been used, cracking has been delayed and, in some cases, eliminated thus extending the life of the chip seal. Hot poured products are typically

used for cracks between ¼ and 1 inch in width. Sand slurry emulsions are typically more economical for crack widths one inch or greater. There are proprietary products that are effective on very wide cracks. Minor cracks will be addressed by the application of emulsified asphalt during placement of the chip seal. Cracks on chip seal routes should be sealed one year in advance of the chip seal placement to allow crack sealing materials to cure.

### **7.1.3 DESIGN CONSIDERATIONS**

#### *7.1.3.1 Mainline Shoulders*

Shoulders on chip seal roadways do not require treatment as often as the pavement in the travel lane. Shoulders shall only receive a chip seal if warranted by pavement condition.

#### *7.1.3.2 Recessed Lane Markers and Rumble Strips*

Evaluate the existing pavement thickness and condition to determine if rumble strips can be installed on chip seal roadways without causing premature damage to the pavement. If recessed lane markers or rumble strips are used, the existing chip seal surfacing should have a minimum thickness of 0.25 ft., which can include any combinations of chip seal and HMA applications.

Grinding rumble strips on chip seal roadways exposes the previous chip seal layers. Exposure to moisture accumulation and freezing and thawing often leads to delamination. To reduce the possibility of delamination at rumble strip locations, rumble strips shall be ground prior to the chip seal application.

Roadways to receive subsequent chip seals shall be evaluated to determine if the depth of the remaining rumble strips are adequate to allow an additional chip seal. Previous WSDOT experience has shown that a chip seal can be placed over existing rumble strips once and still be effective. Where rumble strips need to be reground, preleveling may be required to remove distressed pavement and provide sufficient pavement structure.

#### *7.1.3.3 Chip Seals over New HMA Overlays*

Chip seal need is generally triggered by one of three conditions:

- Friction: Where a chip seal is placed for friction purposes, the need shall be clearly substantiated by the Region Materials Engineer with supporting friction data;
- Surface Distress: For routes with surface distress as determined by the WSPMS; and

- New HMA: There is strong evidence that application of a chip seal over a new HMA overlay reduces the aging of the HMA binder which reduces top down cracking. This practice of placing a chip seal on HMA within one year following construction of the HMA overlay has been examined by WSDOT with positive findings.

## **7.2 HOT MIX ASPHALT**

Pavement with relatively thin HMA layers (less than six inches) tend to crack from the bottom up requiring replacement of the entire HMA layer at the end of the pavement's life. WSDOT has found that cracking in HMA pavement layers thicker than six inches tends to be from the top of the pavement layer down. Since bottom up cracking is minimal, preservation of these thicker HMA sections involves correcting the top down cracking and other surface distresses leaving the underlying pavement structure intact. If properly maintained the underlying pavement structure can last 50 years or more resulting in a low life cycle cost. HMA preservation should focus on preserving this underlying pavement structure.

### **7.2.1 PAVEMENT DESIGN**

HMA preservation is intended to be non-structural by only replacing the top layer of HMA to remove aged related top-down surface cracking. The thickness of these inlays will be the minimum depth required to remove the majority of the top-down cracking. If additional structure is required, HMA overlay design can be accomplished either by use of the mechanistic-empirical based scheme used in the Everpave<sup>®</sup> computer program or the AASHTO Guide for Design of Pavement Structures (1993), Part III, Chapter 5. The Everpave<sup>®</sup> program is for use with HMA pavements. The AASHTO procedure can be applied to either HMA or PCCP structures. The design period for HMA preservation thickness design for thin inlays/overlays is 15 years.

The Roadway Paving Program cost estimate is based on a pavement inlay depth of 0.15 foot. The required depth for an HMA inlay shall be as noted in the Pavement Design Report. Every effort should be made to keep inlays to the 0.15 foot depth; however, in some cases this may not be possible due to existing structural conditions. Pavement designs greater than 0.15 feet require a detailed analysis, including a pavement design, justifying the increase in thickness.

#### *7.2.1.1 Granular Overlays (Cushion Courses)*

The granular overlay system (often referred to as a "cushion course") is an alternative type of overlay for rehabilitating mostly low volume, rural roads (this does not necessarily imply a low



number of ESALs). The overlay consists of a layer of densely compacted, crushed rock (CSBC) overlain by a generally thin surface layer. The surfacing depth can vary depending on local conditions and requirements; however, the CSBC depth shall not exceed 0.50 feet in order to achieve the maximum structural benefit due to stress stiffening.

#### *7.2.1.2 Subgrade Soils*

Subgrade soil resilient modulus for thin (0.15' or less) overlays or inlays can be obtained from existing soil data or a cursory evaluation of soil conditions. When thicker sections are called for to increase pavement structure, additional soils investigation or deflection survey should be conducted to validate the need for additional structure.

The State Pavement Office performs a pavement deflection survey on selected projects. This survey shall be conducted before the Pavement Design Report to aid the Region Materials Engineer with coring and sampling of each project. The deflection survey shall be conducted, when possible, either in late fall or early spring. The Region Materials Engineer shall coordinate with the State Pavement Office so that most of the deflection surveys are conducted during one time period each year. After conducting the deflection surveys, the State Pavement Office will report the results of the survey to the Region Materials Engineer.

### **7.2.2 PREPARATION OF EXISTING PAVEMENT**

For an HMA thin inlay/overlay to perform well, specific distresses in the existing pavement need to be corrected. There may be multiple methods to address a distressed pavement dependant on the type and severity of distress. For example, cracking can be repaired by full depth pavement repair or planing depending on the depth of the cracking. Various distress repair and overlay strategies should be evaluated to determine which is most cost effective.

#### *7.2.2.1 Prelevel*

The use of prelevel prior to placement of an overlay is strictly limited to the correction of safety related deficiencies unless otherwise stated in the Pavement Design Report. Safety-related uses of prelevel are as follows:

- To remove hazardous “spot” locations, e.g., ponding areas or to restore proper pavement drainage at a specific location.
- To correct deficient superelevation or cross slope when the deficiency is the cause of operational problems as determined from an accident history analysis.

- To address pavement rutting specifically identified in the Pavement Design (rutting of less than  $\frac{3}{8}$  inch will generally be addressed with the overlay).

A shallow grind, with a depth equal to the depth of the ruts is an alternative to prelevel. The cost of grinding versus prelevel should be evaluated when prelevel is needed.

When prelevel is warranted as outlined above, it must be clearly documented in the pavement design and carefully detailed in the contract PS&E so that the use is clearly apparent to the contractor and the construction Project Engineer.

#### *7.2.2.2 Crack Sealing*

The item “crack sealing” will only be used when specified in the Pavement Design Report. Crack sealing will be done only on cracks  $\frac{1}{4}$  inch and wider, see Standard Specification 5-04.3(4)A. Minor cracks will be addressed by the use of tack coat. Use sand slurry to fill cracks wider than 1 inch and all cracks in areas to be overlaid with HMA. Hot poured products should be used for cracks between  $\frac{1}{4}$  and 1 inch in width in areas that will not be paved. Sand slurry emulsions are typically more economical for filling cracks one inch or greater.

#### *7.2.2.3 Pavement Repair*

As WSDOT’s HMA pavements become thicker, due to successive overlays, failures tend to be limited to the surface course. Distress in thicker HMA pavements (generally greater than six inches) typically occurs as top down cracking. Top down cracks often penetrate only the wearing surface of a roadway and do not affect the aggregate base or subgrade. Options for rehabilitating pavements with top down cracking include planing and inlaying or overlaying depending upon the extent and depth of the distress. In most cases, pavement coring will identify the depth of the required pavement repair.

Thinner pavements (generally less than six inches) can experience distress throughout the HMA thickness and sometimes into the aggregate base and subgrade. In these cases, full depth replacement of the HMA may be warranted, however, the repair of the pavement failures can range from removing the entire pavement section to only the depth of the last overlay. Coring shall be performed to determine the depth of required repair. Depending on the distress, removal and replacement of aggregate base and subgrade may be necessary. It is important that the Project Offices work closely with the Region Materials Office to determine the cause and extent of the pavement failures.

While pavement repair is preferred to totally remove the distressed pavement, increasing the overlay depth in localized areas can also be considered if conditions warrant. The additional cost of the overlay, however, shall be compared to the cost of providing pavement repair.

### **7.2.3 DESIGN CONSIDERATIONS**

#### *7.2.3.1 Mainline Thin Mill and Fill Preservation*

Pavement preservation that requires the milling of mainline and inlaying the milled thickness with HMA should extend a minimum of 0.5 foot (preferably a foot) into the shoulder. The extension of the milling into the shoulder moves the resulting longitudinal joint away from traffic and extends pavement life. If rumble strips are distressed, extend the milling to include the rumble strip.

A major advantage of a mill and fill versus an overlay is that a mill and fill allows paving of only the lanes needing immediate preservation. An overlay requires paving of the full width of the roadway regardless of condition often resulting in overlaying of pavement which is not currently in need of preservation. In order to minimize cost, inlay only lanes presently in need of preservation on multilane roadways. Similarly, only mill and fill turn lanes, parking strips and shoulders if warranted by the pavement condition.

#### *7.2.3.2 Mainline Shoulders*

Mainline shoulders will generally require a thin inlay/overlay every other rehabilitation cycle. When shoulders do require treatment, it is often only the portion nearest the travel lane that needs preservation. In these cases, only paving a four or five foot strip nearest fog stripe should be considered.

#### *7.2.3.3 Fog Sealing*

Shoulders shall be fog sealed based on the Region Materials Office recommendations. Lanes paved with dense graded HMA are typically not fog sealed unless an open texture forms shortly after construction. Fog seals to address this issue have been shown to be effective in helping to reduce the excessive surface voids.

#### *7.2.3.4 Pavement Markings, Recessed Lane Markers and Rumble Strips*

Recessed lane markers, methyl methacrylate striping, thermoplastic stop bars, arrows, or other coated materials shall be removed prior to placement of the HMA overlay.

Rumble strips on shoulders may be overlaid with a minimum depth of 0.15 feet HMA as long as there is no shift in the existing lane configuration that will cause the wheel path to cross over the underlying rumble strips. If this is the case, reflection of the underlying rumble strip will occur.

On HMA inlay projects where the rumble strips need replacement, the width of the inlay can be increased outside of the fog line to include the rumble strip area.

Rumble strips on shoulders that will carry traffic as a detour shall be preleveled or ground and inlaid with a minimum depth of 0.15 feet HMA. A typical option is to plane and inlay a three foot width from the fog line towards the shoulder edge.

Rumble strips located between directional traffic shall be preleveled or removed by planing and inlaying. The centerline joint should be offset so that the rumble strips are not ground into the lower density HMA near the joint where practical.

HMA shoulders shall be compacted to the same requirements as the traveled lanes per WSDOT Standard Specification 5-04.3(10) where freeze thaw, heavy moisture or chronic rumble strip distress is present.

#### *7.2.3.5 Increased Milling Depth for Delaminations*

Pavement thicknesses shall not be arbitrarily increased based on perceived concerns that the underlying layers will delaminate on a rotomill and inlay project. A thicker lift can be approved, however, cores obtained at a minimum of 0.25 mile intervals must substantiate that a delaminated layer exists.

#### *7.2.3.6 Tack Coat*

A tack coat is required between all HMA layers (new construction and overlay).

#### *7.2.3.7 Correcting Shoulder Slopes*

Roadways with a 0.02 ft./ft. cross slope on the lanes and 0.05 ft./ft. on the shoulders may be corrected provided the shoulder width is four feet or less. On roadways with shoulders wider than four feet, the correction will be deferred depending on funding.

#### *7.2.3.8 Removal of Open Graded Pavements Prior to Overlays*

Open-graded pavements shall be removed prior to overlaying with dense-graded HMA. Removal of the open-graded asphalt layer is necessary to avoid stripping of the open-graded layer once a

new layer of HMA is placed. On lower volume roadways, cold in-place recycling of an OGEAP layer is an acceptable rehabilitation alternative.

On planing and inlay projects, where only the travelled lanes are preserved, open-graded pavements may remain on the shoulders for many thin inlay/overlay cycles. However, where there is potential for the existing shoulder to become a travelled lane, the open-graded asphalt layer shall be removed prior to any future overlays.

#### *7.2.3.9 HMA Surfaced Bridge Decks*

Most bridges with existing HMA surfaces should be paved at the same time as the adjacent roadway. Even if the HMA on the bridge is in relatively good condition, it is often more cost effective to pave the bridge at the same time as the roadway rather than to pave it later under a standalone project.

Removal of some of the existing HMA prior to paving may be necessary to prevent excess dead load caused by the build-up of HMA layers. To ensure adequate compaction, paving depths should follow the minimum provided in Section 8.2.3. See the Bridge Condition Report or contact the Bridge and Structures Office for specific milling and overlay depth requirements.

### **7.3 PCCP**

Dowel bar retrofit, localized panel replacements (as necessary) and diamond grinding have proven to be effective PCCP preservation methods in Washington State. These preservation options restore transverse joint load transfer, replace PCCP panels that have a high risk of failure, and provide a smooth driving surface.

Preservation of PCCP is limited to dowel bar retrofits, diamond grinding and replacing distressed panels. HMA overlays without pre-treating the existing PCCP are susceptible to reflection cracking and are not an approved method of rehabilitating PCCP.

Dowel bar retrofits can be effective since WSDOT did not place dowels in PCCP up until 1993. Dowel bars placed in the wheel paths have been shown to significantly restore load transfer and hence reduce reoccurring faulting. Dowel bar retrofits can be expected to perform adequately for about 10 to 15 years. Following this, it is common WSDOT experience to observe accelerated slab deterioration.

### **7.3.1 PAVEMENT DESIGN**

PCCP preservation does not increase the structural load carrying capacity of the pavement (other than to improve load transfer across joints) so no specific thickness design requirements apply.

### **7.3.2 DISTRESS CORRECTION**

The focus of PCCP preservation is to correct specific pavement distress and thus extend the life of the pavement and improve serviceability.

#### *7.3.2.1 Faulting/Load Transfer*

Improvement of load transfer should be accomplished by retrofitting the pavement with dowel bars. Ideal candidate projects for dowel bar retrofitting are those PCCP roadways that are 25 to 35 years old and have fault measurements less than  $\frac{1}{8}$  inch. Pavements that are 35 years or older and have faulting greater than  $\frac{1}{2}$  inch shall be considered for diamond grinding only without dowel bar retrofitting.

#### *7.3.2.2 Panel Replacements*

Panels cracked into three or more pieces or settled by more than  $\frac{1}{2}$  inch should be replaced. The minimum panel replacement length is 6 feet. The replacement panel thickness generally matches the existing pavement. Thicker replacement panels require approval by the State Pavement Office. WSDOT's [Panel Replacement Criteria for PCCP Rehabilitation](#) provides additional information on selecting panels for replacement.

#### *7.3.2.3 Diamond Grinding*

Roughness caused by studded tires or faulting should be corrected by diamond grinding. Make the final pass of grinding parallel to the direction of travel for the completed project.

Contractors have requested additional compensation on several projects based on the ruts in the field being deeper than the rut depths indicated in the contract. When PCCP grinding is required, there needs to be a method for the contractor to assess the rut depth accurately. One method that appears to have been successful on several projects is to provide a time when the contractors can access the site during lane closures.

The accuracy of rut depth data collected by the State Pavement Office is only sufficient for system wide analysis and is not accurate enough for bidding purposes. If rut depth data collected by the

State Pavement Office is provided to the contractor, it must be made clear the data is for information only.

#### 7.3.2.4 *Shoulders*

Shoulders should be evaluated for preservation at the time of PCCP preservation. Diamond grinding of the adjacent PCCP often requires the grinding of existing shoulder to prevent leaving a vertical edge between the lane and shoulder.

#### 7.3.2.5 *Hot Mix Asphalt Overlays of PCCP*

Overlaying HMA on PCCP includes a range of rehabilitation strategies that must be considered including the condition of the existing PCCP and whether the PCCP is doweled or non-doweled.

Non-Doweled PCCP: HMA overlays without pre-treating the existing PCCP are susceptible to reflection cracking and are not an approved method of rehabilitating PCCP. Pre-treatment of non-doweled pavement may consist of panel replacements, dowel bar retrofitting or a combination of both. In some instances, cracking and seating and overlaying may be a suitable option.

Doweled PCCP: Diamond grinding can become problematic for PCCP with dowels as each successive diamond grind reduces concrete cover above the dowels. PCCP with less than three inches of concrete cover over the dowel bars should not be ground. Overlaying doweled PCCP with HMA requires approval from the State Pavement Office.

Normally non-doweled pavements will require a thicker overlay as compared to doweled pavements. In either case, overlaying PCCP with HMA requires approval from the State Pavement Office.

## **7.4 OTHER PAVEMENT PRESERVATION TREATMENTS**

The bulk of WSDOT flexible pavement preservation consists of single chip seals and HMA inlays. These strategies have proven to be a cost effective means to preserve highways in Washington State. However, other preservation treatments are used to successfully preserve pavements. These treatments may be considered when selecting a preservation treatment. The Table 7.1 details the applicability of some of these treatments:

**Table 7.1 Applicability of Preservation Treatments**

<b>Treatment Option</b>	<b>Candidate Pavement</b>	<b>Distress Corrected</b>	<b>Traffic Limitations</b>	<b>Other</b>
Hot Chip Seal	Chip seal projects where time to open to traffic or loose chips is a factor	Same as chip seal	Lane closures, can be opened to traffic sooner than a conventional chip seal	Reduces the amount of loose chips and dust
Double Chip Seal	Flushed roadways or where a more durable chip seal is needed	Same as chip seal	Same as chip seal	Two chip sizes are often used
Hot In-Place Recycling	HMA pavements that do not have deep failure or materials problems	Surface cracking, ravelling	Lengthy lane closures required during paving	Best suited for roadways without sharp curves, few side roads or driveways and few overhead utilities, not suitable for wearing surface

#### **7.4.1 HOT CHIP SEALS**

Hot chip seals consist of an application of asphalt binder followed by application of aggregate similar to a standard chip seal. Unlike a standard chip seal, the aggregate is pre-coated with asphalt at an asphalt plant before it is placed on the roadway. Pre-coating the chips improves the binding to the roadway and reduces dust allowing the roadway to be opened to traffic sooner than a conventional chip seal. A hot chip seal should be considered on higher volume roadways to allow earlier opening to traffic without excessive loose chips.

#### **7.4.2 DOUBLE CHIP SEAL**

A double chip seal is essentially two single chip seals, one placed on top of the other. The chip size of the second application is often smaller than the first allowing for improved “key in” of the chips. WSDOT has successfully constructed a double chip seal using the same aggregate for both applications. Double chip seals are often used where damage by truck traffic is an issue.

#### **7.4.3 HOT IN-PLACE RECYCLING**

Hot in-place recycling (HIR) employs a train of specialized equipment to remove, process and repave the existing pavement in one pass. The HIR recycling train is slower and less manoeuvrable than conventional paving equipment. Roadways with sharp curves or many side



streets and driveways that must be kept open to traffic may not be good candidates for HIR. The HIR equipment also needs sufficient space off the roadway at about one to two mile intervals to park the HIR equipment between shifts. HIR is capable of recycling the top two inches of the pavement at a constant width of about 12 feet. The constant width makes it difficult to use HIR on wider travel lanes or roadways where there are many turn lanes that require preservation. The addition of recycling agents and aggregate allow some improvement of the recycled HMA but existing pavement with severe materials problems like stripping should be avoided. Paving fabrics and an excess of rubberized crack sealers can also be problematic. HIR can be considered as an alternate to an inlay where the roadway geometrics are compatible with the HIR equipment. HIR is susceptible to ravelling and is not suitable for use as a final wearing surface. A surface treatment or HMA overlay is required to be placed over all HIR pavements.

## **7.5. STRATEGIC MAINTENANCE**

Preventive Preservation is anticipated, planned work designed to extend the service life of a roadway one to six years and to maximize the time between pavement preservation treatments. WSDOT Maintenance personnel usually perform preventive preservation work but the work can be performed under contract. The goals of preventive preservations include:

- Maintain serviceability
- Extend pavement life
- Lower the life cycle cost of the pavement

### **7.5.1 CHIP SEALS**

Due to their relatively short service life, preventive preservation of chip seal surfaced roadways should kept to a minimum to maintain serviceability and hold the pavement in its present condition until the next chip seal. Since chip seals are a form of Preventive Preservation treatment, using an early seal coat treatment to slow deterioration is not practical.

Crack sealing is a good choice of preservation treatment for a chip seal because the crack sealing can be incorporated into a future chip seal. If the sealant is still in good condition, the new chip seal can be placed over the sealed cracks eliminating the need to seal the cracks as part of the chip seal project. Patching may be required for areas with delamination, depressions in the roadway, shoving or flushing since these types of distress may indicate a deeper failure.

### **7.5.2 HOT MIX ASPHALT**

Hot mix asphalt can benefit from both early preventive preservation to slow deterioration and repairing the worst areas to extend pavement life. Placing a seal coat to slow down asphalt binder aging over the HMA before significant distress has occurred will help slow deterioration. The seal coat protects the HMA surface from the environment and slows the asphalt binder aging process delaying the onset of cracking. There has been limited use of early seal coats on HMA pavement in Washington but it is standard practice in some states.

WSDOT conducted an extensive long-term [Preventive Maintenance Study](#) of using preservation treatments to repair distressed areas of HMA pavements to extend pavement life (Anderson et al.). The study looked at crack sealing, chip sealing, patching and thin overlays to preserve roadways that were at or near the due date for rehabilitation. All treatment types extended pavement life provided the treatment was appropriate for the distress and was performed at the right time. The result of this study indicate that selective preventive preservation is able to cost effectively extend pavement life. To take advantage of the saving, WSDOT has implemented a policy to require at least one application of preventive preservation before programming a capital preservation project.

### **7.5.3 PCCP**

Preventive preservation of PCCP involves diamond grinding, dowel bar retrofitting, and repairing cracked or spalled PCCP panels. The scale and equipment required for dowel bar retrofits and PCCP grinding projects limits this type of work to capital preservation projects. When panel replacement and spall repair can extend pavement life, Preventive Preservation by WSDOT Maintenance can be cost effective.

## **7.6. SKID COLLISION REDUCTION POLICY**

Friction is an important pavement characteristic. In addition to structure, ride and rutting, friction must be addressed to preserve a pavement's serviceability. WSDOT's Skid Collision Reduction Policy is described in detail in the following sections.

### **7.6.1 SKID COLLISION REDUCTION**

This Policy Statement provides guidance for the use of pavement friction tests collected by the State Pavement Office. This Policy Statement is adopted from WSDOT Policy P 2035 dated May 18, 2011 which has been retired.

### **7.6.2 BACKGROUND**

The FHWA Technical Advisory on Pavement Friction Management ([T 5040.38](#)) states that “. . . a state highway agency should implement a program to manage pavement friction on its public roads.” The advisory refers to the American Association of State Highway Transportation Officials (AASHTO) *Guide for Pavement Friction* (AASHTO, 2008) as the source of information for developing a pavement friction program.

WSDOT is in the process of developing a friction management program. Until that program is developed, WSDOT will follow the procedure described in this Skid Collision Reduction Policy.

The literature maintains that collision histories are the best indicators of the cause of wet weather collisions. Wet weather collisions may be caused by complex interactions among roadway, vehicle, human, and environmental factors. Collisions may result from unpredictable factors and random variables.

### **7.6.1 POLICY STATEMENT**

It is the policy of WSDOT to minimize the risk of wet weather skid collisions by using the Skid Collision Reduction Policy as follows.

The following rules and responsibilities are established.

#### *7.6.1.1 Test Pavement Friction Every Two Years*

Pavement friction tests must be conducted on state routes every two years at one-mile intervals to help identify potential skid collision locations.

- Undivided roads are tested only in one direction.
- Divided roads with fewer than three lanes are tested in both directions in the outer lane.
- Divided roads with three or more lanes are tested in both directions in the second lane from the outside.

#### 7.6.1.2 *Identify and Rank Safety Needs*

Use these two primary sources to identify and rank statewide safety needs:

- Crash history analysis.
- Roadway geometric/condition modeling that uses skid number assessment. Skid numbers are considered in the development of appropriate solutions to address both collision history and potential collision locations.

#### 7.6.1.3 *Locations with Skid Numbers at or Below 30*

Locations with skid numbers at or below 30 must be retested promptly. These retests must be completed within the same calendar year and reported to regional authorities. Corrective actions may be required depending on analyses and site inspections.

#### 7.6.1.4 *Pavement Office*

The Pavement Office is responsible for the following:

- Test pavement friction on a systematic basis (ASTM E-274-Rib Tire) throughout the state highway system on a two-year cycle.
- Test newly constructed or overlaid pavement that is one lane mile or longer one month or more after completion and before the construction season ends, unless prevented by weather conditions.
- Retest locations with skid numbers at or below 30 promptly.
  - Retests consist of at least five friction tests taken within one quarter mile of the point of the skid number at or below 30.
  - Retests report the original low skid number.
  - Retests report the average of the five retests.
- Provide the pavement friction test results to the Regional Administrator.

#### 7.6.1.5 *Regional Administrator*

The Regional Administrator is responsible for the following:

- Manage the Skid Reduction Program within the region to ensure compliance with this Policy Statement.

## WSDOT Pavement Policy

- Provide the pavement friction test results to the Region Operations Engineer.
- In the absence of a Region Operations Engineer, designate a position to carry out those responsibilities and inform the Assistant Secretary.

### *7.6.1.6 Region Operations Engineer or Designee*

The Region Operations Engineer or designee is responsible for the following:

- Review friction test results.
- Compare prior pavement friction test results at or below 30 with current friction test results. Determine whether or not adverse collision history has developed at these locations. If so, check whether or not improvements have been scheduled or completed.
- Review pavement friction test results with skid numbers at or below 30 with the Region Maintenance Engineer and Region Traffic Engineer.
- When tests and reviews indicate it is needed, coordinate construction improvements with the Region Maintenance Area Superintendent or with the Region Project Development Office.

### *7.6.1.7 Region Maintenance Area Superintendent*

The Region Maintenance Area Superintendent is responsible for the following:

- Conduct joint field reviews with the Region Traffic Engineer at each site that has skid numbers at or below 30.
- Schedule construction of the appropriate surface treatment to improve skid resistance.
  - Use state forces or contract.
  - Inform the Region Operations Engineer or designee.
- Remove any “Slippery When Wet” signs installed and inform the Region Traffic Engineer.

### *7.6.1.8 Region Traffic Engineer*

The Region Traffic Engineer is responsible for the following:

- Conduct joint field reviews with the Region Maintenance Area Superintendent at each site that has skid numbers at or below 30.

## WSDOT Pavement Policy

- Analyze traffic data records to determine high or potentially high risk of wet weather collision rates in those areas with skid numbers at or below 30.
- At locations where crash rates or roadway/roadside modeling indicates that a problem exists, recommend solutions either to the Region Operations Engineer or the Region Maintenance Area Superintendent for correction.
- Direct installation of “Slippery When Wet” signs, when needed, at sites with average skid numbers at or below 30.
- Direct other immediate corrective action as needed.

### *7.6.1.9 Region Program Management*

The Region Program Management Office is responsible to program suitable improvements at locations having a low skid number and a high collision rate, where maintenance has not yet made alterations.

## **8. DESIGN DETAILS**

This section provides design standards that are relevant to all phases of pavement design: new pavement, rehabilitation and preservation. These requirements are to be followed when designing the applicable pavement type or situation.

### **8.1 GENERAL DESIGN DETAILS**

#### **8.1.1 TRAFFIC DATA**

Traffic data from the Transportation Information and Planning Support (TRIP's) traffic file will be used on most projects, as contained in the Washington State Pavement Management System (WSPMS). Where the State Pavement Office or Region Materials Engineer believes the data in the file is not adequate, a special traffic count on the project can be requested to verify the data. If the region does not have personnel to conduct the traffic counts, the Transportation Data, GIS and Modeling Office shall be contacted for assistance.

#### **8.1.2 SUBGRADE DRAINAGE**

For a pavement section to perform well, a system must be provided to avoid prolonged periods of high water content in the base and subgrade. Excess water under the pavement weakens subgrade and unbound base layers, increases the potential for frost heave and can result in pumping with the associated faulting and loss of support. WSDOT's standard practice for providing subgrade drainage is to use a layer of CSBC under the bound pavement layers. For most pavements in Washington, a CSBC layer is adequate to remove any water that enters through cracks and openings in the pavement surface.

Unless the underlying soil is highly permeable, a path needs to be provided for water in the CSBC layer to exit the pavement structure. The preferred method is to daylight the CSBC in the side slope or ditch. If daylighting the CSBC is not possible, an underdrain parallel to the roadway needs to be installed adjacent to the paved shoulder and below the CSBC layer. The underdrain should be connected to the storm drainage system or be routed to another suitable discharge location. Underdrain systems must receive periodic maintenance to remain effective.

## 8.2 HMA DESIGN DETAILS

### 8.2.1 ESAL LEVEL FOR DEVELOPING HMA MIX DESIGN

For HMA roadways the HMA mix designs ESALs shall be based on 15 years.

In order to reduce the likelihood of stripping, the mix design ESALs for HMA under PCCP shall be less than 0.3 million.

HMA shoulders on PCCP roadways are often required to go for long intervals between repaving. To produce a durable mix, the preferred mix design ESALs are less than 0.3 million. If there is other HMA work on the project and the quantity of shoulder HMA is small, consideration should be given to using the same mix design ESALs as the other HMA on the project.

WSDOT has found that HMA mixes designed for 30 million ESALs or more (125 gyrations) are prone to premature cracking and raveling due to the lower binder content. Only use mix designs of 30 million ESALs or higher where severe rutting has occurred in the past and other methods will not mitigate the rutting. The use of mix designs with ESALs of 30 million or more requires State Pavement Office approval.

### 8.2.2 PG BINDER SELECTION CRITERIA

WSDOT uses the Multiple Stress Creep Recovery Test (MSCR) to grade HMA binders. Performance-Graded Binder used within travel lanes on state routes should conform the following table.

**Table. 8-1 Performance-Graded Binder Selection**

ESAL Level or Traffic Speed			Binder Grade	
15-Year ESALs (millions)		Traffic Speed (mph)	Eastern Washington (Including Mountain Passes)	Western Washington
< 7	and	> 40	PG64H-28*	PG58H-22*
7 to 20	or	15 to 40	PG64H-28	PG58H-22
> 20	and/or	< 15	PG64V-28	PG58V-22

\*Use PG58H-22 or PG64H-28 on all WSDOT projects. PG58S-22 or PG64S-28 may be used on other projects at the discretion of the contracting agency.



The binder-grade selection criteria is based on 15-year ESALs. Select the binder grade that corresponds to the HMA on the project that will carry the highest 15-year ESAL level or lowest traffic speed on the project. When the ESAL level or traffic speed indicates that more than one grade of binder could be used on a project, and using multiple binder grades is not desirable, binder grades may be substituted as follows: Binders with a High Designation “H” may be substituted for binders with a Standard Designation “S”. Binders with a Very High Designation “V” may be substituted for binders with an “S” or “H” designation.

Use the same binder grade for all lifts of HMA regardless of depth.

HMA used under PCCP should be PG64H-28 in Eastern Washington including Mountain Passes and PG58H-22 in Western Washington.

As an alternative to the above binder selection criteria, the LTPP Bind Online tool located at the [LTPP InfoPave](#) website may be used to determine the binder grade. The following inputs should be used:

Target Rutting Depth (mm):	12.5
ESALs:	Use 20 years ESALs
Base HT PG:	64 east / 58 west

Adjust the temperatures of the resulting MSCR binder grade from LTPP Bind Online to the temperature grade corresponding to a grade on Table 8.1. For example, LTPP Bind Online results in a grade of PG52H-16 for a project in Western Washington. The binder grade would need to be adjusted to PG58H-22 to match the temperature of the standard grade used by projects in Western Washington. Binders with an “S” designation in LTPP Bind Online would also need to be adjusted to an “H” designation for WSDOT projects.

### **8.2.3 MINIMUM HMA LIFT THICKNESS**

To ensure that adequate compaction is achieved, the following minimum lift thicknesses by class of mix shall be followed. Deviations from the minimum requirements need approval from the State Pavement Office:

**Table 8.2 HMA Minimum Lift Thickness**

<b>Class of HMA Mix</b>	<b>Minimum Lift Thickness ft.</b>
3/8 inch	0.10
1/2 inch	0.15
3/4 inch	0.22
1 inch	0.30

**8.2.4 HMA FOR PCCP BASE AND SHOULDERS**

HMA used beneath PCCP and HMA shoulders on PCCP roadways shall be compacted to the same requirements as the traveled lanes per WSDOT Standard Specification 5-04.3(10).

The HMA base under new PCCP should extend a minimum of 6 inches beyond the edge of the PCCP to ensure a stable base is provided at the edge of the concrete.

**8.2.5 LONGITUDINAL JOINTS**

Longitudinal joints placed in the wheel path perform poorly and often require corrective maintenance work before the rest of the pavement. Widening an existing roadway often results in the longitudinal joint between the old and new pavement that is in the wheel path. In these situations place the final lift of HMA so the longitudinal joints in the final lift is on the lane line. This may require staging the project so that the entire roadway is inlayed or overlaid following completion of the widening or grinding a portion of the existing pavement so the full width of the final lift in the new lane can be paved in one pass.

**8.2.6 MOUNTAIN PASS PAVING CRITERIA**

WSDOT has experienced repeated HMA pavement with poor performance or failures on mountain passes. To ensure the highest level of performance the following design/construction elements are required:

- Utilize a Material Transfer Vehicle (MTV) such as a Shuttle Buggy
- Use a notch wedge joint for all longitudinal joints with an unconfined edge
- Place longitudinal joint adhesive on the vertical face of the notch wedge joint

- Compact shoulders to the same requirements as the traveled lanes in accordance with WSDOT Standard Specification 5-04.3(10)
- Extend paving limits to one foot beyond the edge stripe or outside the existing rumble strips
- Utilize trucks with tarps during the placement of HMA
- Require cyclic density testing or the use of a Pave-IR system to eliminate cyclic temperature differentials in the HMA
- Consider the use of HMA Class 3/8 inch for the wearing course.
- Require HMA paving be complete before the onset of cold weather that will make achieving density difficult.

### **8.3 PCCP DESIGN DETAILS**

#### **8.3.1 USE OF WIDENED OUTSIDE LANE**

If shoulders are constructed with HMA, at a minimum, the right most lane (truck lane) shall be constructed 14 feet wide and striped at 12 feet.

#### **8.3.2 DOWEL BARS AND TIE BARS**

Newly constructed PCCP shall use corrosion resistant dowel bars conforming to Standard Specification 9-07.5(2) (stainless steel, zinc clad etc.). Dowel bar selection criteria for mainline roadway, roundabouts, intersections and shoulders are detailed in Appendix 1.

PCCP shoulders shall be tied in all cases and doweled if expected to carry future traffic.

Dowels shall be used for the entire transverse joint where a widened PCCP lane (see 9.3.1) is constructed in the right shoulder. The dowel bars should be placed starting 1.0 foot from the longitudinal joint between the PCCP panel and the HMA shoulder.

#### **8.3.3 SHOULDERS**

The PCCP placed on shoulders shall be placed concurrent with the outside lane.

#### **8.3.4 JOINTING PLANS**

The Standard Plans provide jointing details for mainline PCCP travel lanes and shoulders. Additional jointing details are required to be included in the contract plans for jointing layouts that

are not covered in the Standard Plans such as intersections, roundabouts and tapers. Include proposed joint locations, joint type and isolation joints for utilities. Identify where dowel bars and tie bars are required in the jointing plans. Submit jointing plans to the State Pavement Office for approval with the pavement design report or during PS&E development.

The jointing plan included in the contract documents provides a baseline for pavement construction but there are often alternative joint locations that will provide equivalent pavement performance. Contractors are encouraged to propose alternate jointing plans to improve constructability. The State Pavement Office approves alternate jointing proposals.

### 8.3.5 INTERSECTIONS LIMITS

The limits for reconstruction with PCCP shall be determined based on an evaluation of the existing pavement conditions. The area of pavement rutting or distress shall be limited to the vehicle start and stop areas. The major arterial approach legs to intersections may require PCCP from 200 to 500 feet (Uhlmeier, 2003) back from the crosswalk (Figure 8.1).

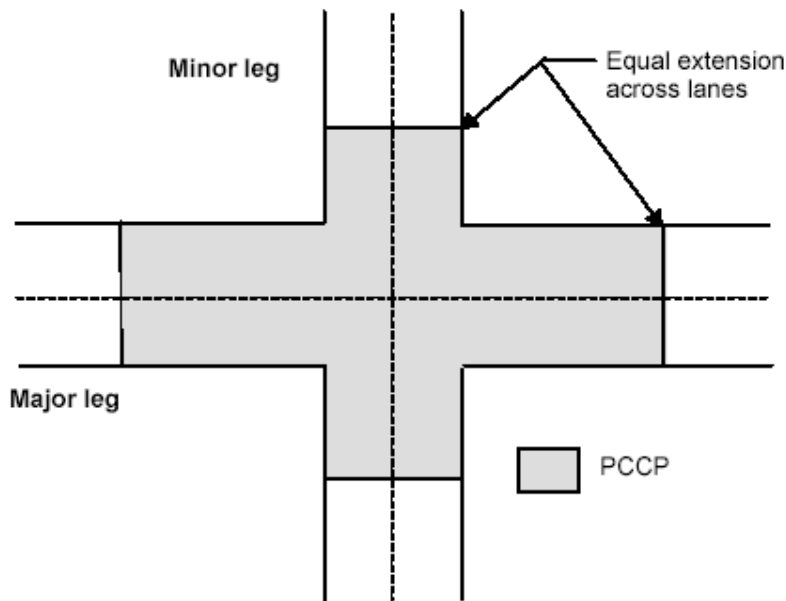

Figure 8.1. PCCP Intersection Limits

## **9. PAVEMENT DESIGN REPORT**

A Pavement Design Report is required for all HMA and PCCP preservation, rehabilitation, reconstruction and new construction projects, and is recommended for chip seal overlays where structural problems are evident. The Region Materials Engineer will prepare the report for review by the State Pavement Office. The report will summarize the existing pavement and site conditions, include discussion of special features or problems, and provide pavement design/rehabilitation requirements.

A Pavement Design Report is optional if all pavement work is incidental to other work on the project provided the new pavement structure is at least equivalent to the existing structure. Examples of incidental pavement work include removing and replacing pavement within the limits of structure excavation or increasing the pavement thickness at bridge ends to match into a bridge overlay. A Pavement Design Report is also not required if all of the pavement work on the project is temporary and will be removed as part of the project. If a Region opts to prepare a Pavement Design Report, an information copy should be sent to the State Pavement Office so it can be scanned and archived.

A Pavement Design Report will generally consist of four elements: a description of the project, an evaluation to the conditions at the project site, the pavement thickness design and the specific design details. Some elements that are specific to pavement preservation and rehabilitation will not be needed in Pavement Design Reports that address the design of new pavement only. Each element is described further in the sections that follow.

### **9.1 PROJECT DESCRIPTION**

Items that need to be included are: a description of the project (including vicinity maps and plan views if needed to describe the project location), purpose of project, present and future lane configuration, status and scope of project, possible construction contingencies, State Route number, milepost limits, project name, work order number, Project Item Number, and anticipated construction dates.

## **9.2 SITE EVALUATION**

The site evaluation includes specific details of the project that will have an impact on the pavement design. At a minimum include the following in the Pavement Design Report:

### **9.2.1 TRAFFIC DATA**

Include the ADT and estimated ESALs in the design period for each pavement section in the design. ESAL data will generally be supplied by WSPMS. An explanation should be included when other sources of ESAL data are used in the design.

### **9.2.2 CLIMATE CONDITIONS**

Unusual climate conditions such as mountain passes or freeze and thaw conditions that affect the design should be described.

### **9.2.3 SUBGRADE SOILS AND GEOLOGY**

Describe soil conditions encountered in the project limits including the basis of the subgrade modulus used in the pavement design in the report. The basis of the subgrade modulus may be a combination of current or previous soils investigations; previous Pavement Design Reports, field samples and falling weight deflect meter deflection testing. If a deflection survey was conducted the results should be included. Include pertinent topographic features as they relate to subgrade soil changes and pavement performance. Provide documentation of the subgrade modulus values included in the pavement design.

### **9.2.4 PAVEMENT CONDITION (PRESERVATION AND REHABILITATION ONLY)**

Description and photographs of existing pavement conditions with reference to pavement distress, subgrade soils, geologic features, drainage, frost distress or traffic. Provide a summary documenting the HMA and base course thicknesses and the nature of the base and subgrade soils (as noted in section 7.2.3). HMA core sampling shall be taken within the travel lanes every 0.25 to 0.50 miles of the projects length in order to provide a mechanistic-empirical design. Areas of distress that require treatment other than the overall roadway (such as frost heaves or localized pavement failures caused by weak subgrade) shall also be noted. Include a table with core location and core condition in the Pavement Design Report along with photos of distressed cores.

### **9.2.5 DRAINAGE AND WATER CONDITIONS**

Drainage and water conditions that affect the pavement design or may affect pavement performance needs to be explained. Describe pertinent drainage features such as ditches, subgrade drains, drainage blankets, etc., both functioning and non-functioning. Where wet subgrades are encountered, moisture contents should be determined.

### **9.2.6 CONSTRUCTION HISTORY (PRESERVATION AND REHABILITATION ONLY)**

Provide a description or layer profile of the pavement structure and limits as they relate to past contracts.

## **9.3 PAVEMENT DESIGN**

The Pavement Design Report shall include PCCP and HMA design thicknesses where new construction warrants alternate pavement types. The specific design method used in the design shall be included along with justification of design inputs that are different than required by the pavement policy. Pavement designs shall be provided in sufficient detail to develop the contract plans.

## **9.4 DESIGN DETAILS**

Specific criteria concerning pavement design such as correction of special problems, unique use of materials or procedures, drainage features, and frost distress corrections shall be documented.

### **9.4.1 MATERIALS**

The report should describe material requirements that are not covered by the Standard Specifications. Explain the use of a PG binder grade other than the base grade for the project location and include the 15 year design ESALs for HMA mix design. Include state owned materials sources along with special materials when warranted.

### **9.4.2 CONSTRUCTION CONSIDERATIONS**

Strategies to correct specific types of pavement distress including preleveling, digouts, subsealing and crack sealing should be included. Items such as project timing, potential problems with materials sources, etc., should be covered.

### **9.4.3 PCCP JOINTING DETAILS**

Any PCCP that requires jointing details other than that shown in the Standard Plans (such as roundabouts, intersections or non-standard pavement sections) shall be approved by the State Pavement Office.

### **9.4.4 BRIDGE**

The HMA bridge deck rehabilitation treatment option selected for each bridge is to be included in the Pavement Design Report. Concurrence from the Bridge and Structures office shall be included if the bridge deck rehabilitation treatment differs from the options listed in the Bridge Condition Report. Attach a copy of the Bridge Condition Report(s) to the Pavement Design Report.

### **9.4.5 SPECIAL FEATURES**

Review any unique features pertinent to the project not covered under other topics.

## **9.5 STATE PAVEMENT OFFICE PAVEMENT DESIGN REPORT APPROVAL**

The State Pavement Office reviews and evaluates the final Pavement Design Report prepared by the Regions for new construction, reconstruction, pavement rehabilitation and pavement preservation. When necessary, a review comments report is prepared for various requirements of the project. Generally, concurrence will be provided in a signature and date block provided in the Region Pavement Design Report.



## REFERENCES

- AASHTO. 1993. *AASHTO Guide for Design of Pavement Structures*. Washington D.C.: American Association of State Highway and Transportation Officials.
- AASHTO. 2008. *Guide for Pavement Friction*. Washington DC: American Association of State Highway and Transportation Officials.
- ACPA. 2016. *Subgrades and Subbases for Concrete Pavements*. Engineering Bulletin EB204P, Skokie IL: American Concrete Pavement Association.
- Anderson, K.W., J.S. Uhlmeyer, and M.A. Russell. 2009. *Use of Recycled Concrete Aggregate in PCCP*. WA-RD 726.1, Olympia, WA: Washington State Department of Transportation.
- Anderson, K.W., J.S. Uhlmeyer, J. Weston, K. Willoughby, M. Russell, and C. Fraisure. 2018. *Preventive Maintenance Study – Final Report*. WA-RD 871.2, Olympia, WA: Washington State Department of Transportation.
- Anderson, K.W., J.S. Uhlmeyer, T. Sexton, M. Russell, and J. Weston. 2014. *Evaluation of Long-Term Pavement Performance and Noise Characteristics of the Next Generation Concrete Surface*. WA-RD 767.2, Olympia, WA: Washington State Department of Transportation.
- Anderson, K.W., J.S. Uhlmeyer, T. Sexton, M. Russell, and J. Weston. 2013. *Summary Report on the Performance of Open Graded Friction Course Quieter Pavements: I-5 Lynnwood, SR-520 Medina, I-405 Bellevue*. WA-RD 817.1, Olympia, WA: Washington State Department of Transportation.
- Anderson, K.W., L.M. Pierce, and J.S. Uhlmeyer. 2008. *Brief History of the Performance of Rubberized Pavements in Washington State*. WA-RD 693.1, Olympia, WA: Washington State Department of Transportation.
- Aschenbrener, T., E.R. Brown, N. Tran, and P.B. Blankenship. 2017. *Demonstration Project for Enhanced Durability of Asphalt Pavements through Increased In-place Pavement Density*. NCAT Report 17-05, Auburn AL: National Center for Asphalt Technology - Auburn University.
- Brown, E.R., M.R. Hainin, A. Cooley, and G. Hurley. 2004. *Relationship of Air Voids, Lift Thickness, and Permeability in Hot Mix Asphalt Pavements*. NCHRP Report 531, Washington D.C.: Transportation Research Board.
- Davids, W.G., and G.M. Turkiyyah. 1998. *G.M., Modeling of Rigid Pavements: Joint Shear Transfer Mechanisms and Finite Element Solution Strategies*. WA-RD 455.1, Olympia, WA: Washington State Department of Transportation.
- Dell'Isola, A.J., and S.J. Kirk. 1981. *Life Cycle Costing for Design Professionals*. New York: McGraw-Hill.
- FHWA. 2016. *Bases and Subbases for Concrete Pavement*. Tech Brief FHWA-HIF-16-005, Washington DC: Federal Highway Administration.
- FHWA. 1998. *Life Cycle Cost Analysis in Pavement Design*. FHWA-SA-98-079, Washington DC: Federal Highway Administration.

FHWA. 2010. *Technical Advisory on Pavement Friction Management*. Washington DC: Federal Highway Administration. Accessed August 2018.  
<https://www.fhwa.dot.gov/pavement/t504038.cfm#p01>.

FHWA. 1987. *Techniques for Pavement Rehabilitation, Participants Notebook FHWA-HI-90-022*. Washington DC: Federal Highway Association.

Hansen, M., J. Mahoney, N. Jackson, C. Hunter, and L. Pierce. 2007. *Assessment of the I-5 Portland Cement Concrete Pavements in King County*. WA-RD 682.1, Olympia, WA: Washington State Department of Transportation.

Jackson, D.C., N.C. Jackson, and J.P. Mahoney. 1990. "Washington State Chip Seal Study." *Transportation Research Record, Journal of the Transportation Research Board Issue 1259* 1-10.

Jackson, N., J. Mahoney, and J. Puccinelli. 2014. *Using Existing Pavement in Place and Achieving Long Life*. SHRP 2 Report S2-R23-RR-1, Washington D.C: Transportation Research Board.

Jackson, N., J. Puccinelli, and J. Mahoney. 2014. *Guide to Using Existing Pavement in Place and Achieving Long Life*. SHRP 2 Report S2-R23-RW-2, Washington D.C.: Transportation Research Board.

Jackson, N.C., and D.J. O'Neil. 1991. *An Evaluation of Granular Overlays in Washington State - A Summary*. WA-RD, Olympia, WA: Washington State Department of Transportation.

Kay, K., and N.C. Jackson. 1988. *Pavement Performance Equations*. WA-RD 143.1, Olympia, WA: Washington State Department of Transportation.

Kay, K., and N.C. Jackson. 1993. *The WSDOT Pavement Management System - A 1993 Update*. WA-RD 274.1, Olympia, WA: Washington State Department of Transportation.

Kleskovic, P.Z. 1980. *A Discussion of Discount Rates for Economic Analysis of Pavement, Draft Report*. Washington DC: FHWA Pavement Division.

Lary, J.A., and J. Sharma. 1984. *Evaluation of Frost Related Effects on Pavements*. WA-RD 67.1, Olympia, WA: Washington State Department of Transportation.

Lee, S.W., N.C. Jackson, and D.E. Newcomb. 1988. *Mechanistic-Based Overlay Design Procedure for Washington State Flexible Pavements*. WA-RD 170.1, Olympia, WA: Washington State Department of Transportation.

Li, J., D.R. Luhr, J.S. Uhlmeier, and J.P. Mahoney. 2014. *Evaluation of Maintenance Effectiveness for WSDOT Pavement Network*. Transportation Research Board 93rd Annual Meeting, Washington D.C.: Transportation Research Board.

Li, J., D.R. Luhr, M. Russell, T. Rydholm, and J.S. Uhlmeier. 2017. "Cost Effective Performance Management for Washington State Pavement Assets." *Transportation Research Record: Journal of the Transportation Research Board Issue 2639* 102-109.

Li, J., Uhlmeier, J.S., J.P. Mahoney, and S.T. Muench. 2010. "Updating the Pavement Design Guide Catalog for the Washington State Department of Transportation: Using 1993 AASHTO Guide, Mechanistic Empirical Pavement Design Guide, and Historical Performance." *Transportation Research Record: Journal of the Transportation Research Board Issue 2154* (Transportation Research Board) 124-129.

Linden, R.L., J.P. Mahoney, and N.C. Jackson. 1989. "Effects of Compaction on Asphalt Concrete Performance." *Transportation Research Record Journal of the Transportation Research Board Issue 1271* 20-28.

Luhr, D.R., J. Li, J.S. Uhlmeier, and J.P. Mahoney. 2012. "Preservation Strategies for Concrete Pavement Network of Washington State Department of Transportation." *Transportation Research Record: Journal of the Transportation Research Board Issue 2306* 11-20.

Luhr, D.R., J. Li, J.S. Uhlmeier, and J.P. Mahoney. 2012. "Preservation Strategies for Flexible Pavement Network of Washington State Department of Transportation." *Transportation Research Record: Journal of the Transportation Research Board Issue 2306* 28-35.

Mahoney, J.P., C.L. Monismith, J. Coplantz, J.T. Harvey, V. Kannekanti, L.M. Pierce, J.S. Uhlmeier, N. Sivanesswarn, and T. Hoover. 2007. *Pavement Lessons from the 50-Year-Old Interstate highway System: California, Oregon, and Washington*. Transportation Research Circular E-C118, Washington D.C.: Transportation Research Board.

Mahoney, J.P., M. Slater, C. Keifenheim, J. Uhlmeier, T. Moomaw, and K. Willoughby. 2014. *WSDOT Chip Seal Optimal Timing, Design and Construction considerations*. WA-RD 837.1, Olympia, WA: Washington State Transportation Center, Washington State Department of Transportation.

Mahoney, J.P., M.S. Rutherford, and R.G. Hicks. 1986. *Guidelines for Spring Highway Use - Criteria for Highway Load Restrictions: Where, How Much and When*. WA-RD 80.2, Olympia WA: Washington State Transportation Center, Washington Department of Transportation.

Mallick, R.B., Cooley Jr. L.A., M.R. Teto, R.L. Bradbury, and D. Peabody. 2003. *An Evaluation of Factors Affecting Permeability of Superpave Designed Pavements – NCAT Report 03-02*. NCAT Report 03-02, Auburn AL: National Center for Asphalt Technology, Auburn University.

Maupin, Jr. G.W. 2010. *Investigation of Optimized Mixture Design for Superpave Surface Mixtures*. Final Report VTRC 11-R5, Charlottesville VA: Virginia Transportation Research Council.

MnDOT. 2014. *Best Practices in Pavement Design for Design-Build Projects*. Transportation Research Synthesis 1402, Saint Paul, MN: Minnesota Department of Transportation.

Muench, S.T., and J.P. Mahoney. 2001. *A Quantification and Evaluation of WSDOT's Statistical Acceptance Specification*. WA-RD 490.2, Olympia, WA: Washington State Department of Transportation.

Muench, S.T., L.M. Pierce, J.S. Uhlmeier, and K.W. Anderson. 2010. *A Brief History of Long-Life WSDOT Concrete Pavements*. WA-RD 744.2, Olympia, WA: Washington State Department of Transportation.

Newcomb, D.E., A.A. Bubushait, and J. Sharma. 1983. *State-of-the-Art on Pavement Overlay Design Procedures, Vol. I and II*. WA-RD 65.1 and 65.2, Olympia, WA: Washington State Department of Transportation.

OMB. 1992 - Updated 2015. *Guidelines and Discount Rates for Benefit-Cost Analysis of Federal Programs, Circular No. A-94 (Revised)*. Office of Management and Budget.

Penn DOT. 2001. *Publication 242 - Pavement Policy Manual*. Pennsylvania Department of Transportation.

Peters-Davis, K., and D.H. Timm. 2009. *Recalibration of the Asphalt Layer Coefficient*. NCAT Report 09-03, Auburn AL: National Center for Asphalt Technology - Auburn University.

Peterson, D.E. 1985. *Life Cycle Cost Analysis of Pavements*. NCHRP Synthesis of Highway Practice No. 122, Washington DC: Highway Research Board.

Pierce, L.M. 1994. "Portland Cement Concrete Pavement Rehabilitation in Washington State: Case Study." *Transportation Research Record, Journal of the Transportation Research Board Issue 1449* 189-198.

Pierce, L.M., and S.T. Muench. 2009. *Evaluation of Dowel Bar Retrofit for Long-Term Pavement Life in Washington State*. WA-RD 727.1, Olympia, WA: Washington State Department of Transportation.

Pierce, L.M., J.P. Mahoney, Muench S.T., J. Li, J.S. Uhlmeyer, K. Willoughby, and D.R. Luhr. 2010. "Utilization of Bituminous Surface Treatments for Maintaining Asphalt Concrete Pavements Due to Restricted Budgetary Constraints in Washington State." *Compendium of Papers from the First International Conference on Pavement Preservation*. Newport Beach CA: California Department of Transportation; Federal Highway Administration; Foundation for Pavement Preservation. 73-84.

Pierce, L.M., J.S. Uhlmeyer, and J.T. Weston. 2009. *Dowel Bar Retrofit Do's and Don'ts*. WA-RD 576.1, Olympia, WA: Washington State Department of Transportation.

rePave. 2014. *SHRP2 R23 Scoping Methodology Including Advanced Renewal Systems*. Accessed May 27, 2015. <http://www.pavementrenewal.org/>.

Rutherford, M.S., R.G. Hicks, and T. Rwebangira. 1985. *Guidelines for Spring Highway Use Restrictions*. WA-RD 80.1 and FHWA - RD-86-501, Olympia, WA: Washington State Department of Transportation.

Sharma, J., and J. Hallin. 1983. *Evaluation of Present Legislation and Regulations on Tire Sizes, Configurations and Load Limits*. WA-RD 59.1, Olympia, WA: Washington State Department of Transportation.

Tayabji, S., and L. Seungwook. 2007. *Tech Brief – Long-Life Concrete Pavements: Best Practices and Directions from the States*. Tech Brief FHWA-HIF-07-030, Washington D.C.: Federal Highway Administration.

TRB. 2005. *Factors Affecting Compaction of Asphalt Pavements*. Transportation Research Circular E-C105, Washington D.C.: Transportation Research Board.

Uhlmeyer, J.S. 2003. *PCCP Intersections Design and Construction in Washington State*. WA-RD 503.2, Olympia, WA: Washington State Department of Transportation.

Uhlmeyer, J.S., J.P. Mahoney, J.S. Lovejoy, and G.E. Gibson. 2001. "Granular Overlays on Low-Volume Roads in Washington State." *Transportation Research Record, Journal of the Transportation Research Board Issue 1778* 182-190.

Uhlmeyer, J.S., K. Willoughby, L.M. Pierce, and J.P. Mahoney. 2000. "Top-Down Cracking in Washington State Asphalt Wearing Courses." *Transportation Research Record 1730* (Transportation Research Board) 110-116.

Willoughby, K., and J. Mahoney. 2007. *An Assessment of WSDOT's Hot Mix Asphalt Quality Control and Assurance Requirements*. WA-RD 517.2, Olympia, WA: Washington State Department of Transportation.

Willoughby, K.A., J.P. Mahoney, L.M. Pierce, J.S. Uhlmeyer, K.W. Anderson, S. Read, S.T. Muench, T.R. Thompson, and R. Moore. 2001. *Construction-Related Asphalt Concrete Pavement Temperature Differentials and the Corresponding Density Differentials*. WA-RD 476.1, Olympia, WA: Washington State Department of Transportation.

Winters, B.C., K. Chatti, T.J. Moran, C.L. Monismith, and S.L. Kramer. 1995. *Vehicle/Pavement Interaction at the PACCAR Test Site*. WA-RD 384.1, Olympia, WA: Washington State Department of Transportation.

WSDOT. 1995. *WSDOT Pavement Guide, Volumes 1 and 2, Final*. Olympia, WA: Washington State Department of Transportation.



## APPENDIX 1 – DOWEL BAR TYPE SELECTION

Dowel bars in portland cement concrete pavement (PCCP) have been proven to extend pavement life. Dowel bars transfer loads from panel to panel, supplementing the aggregate interlock at the panel joint. Aggregate interlock degrades over time, while dowel bars are expected to continue to be effective for upwards of 50 years. WSDOT designs PCCP to last 50 years, so it is critical that the dowel bars remain intact and functional, for this period.

Different materials used for dowel bars have different performance lives, given various exposures to weather and corrosive chemicals. The hardest environment for dowel bars are wet locations with exposure to salts/corrosive agents (either naturally from the environment, such as sea spray, or from chemical anti-icing compounds). Dowel bars placed in dry climates without exposure to salts/corrosive agents experience the mildest environment. For the same moisture and salt/corrosive environment, warmer climates would induce more corrosion than colder environments.

The purpose of the dowel bar type selection process is to balance risk and cost. In an unconstrained funding scenario, one would select the least risky dowel bar material: the one most resistant to corrosion. WSDOT will always be under some type of funding constraint. Risk and cost, for each type of dowel bar material, is illustrated in the following table:

Dowel Bar Type	Cost	Corrosion Resistance
Solid stainless steel	Most expensive	Best corrosion resistance
Stainless steel clad	↓	↓
Stainless steel sleeve with epoxy coated insert	↓	↓
Low-carbon chromium steel (patented steel bar) and Jarden Lifejacket® dowel bar (zinc clad	↓	↓
Epoxy coated (AASHTO M-284)	↓	↓
Black steel (uncoated)	Least expensive	Worst corrosion resistance

Corrosion resistance increases as does cost when moving from black steel to stainless steel dowels. Additionally, there is a direct link, then, between risk and cost: less risk, higher cost; lowest cost, greatest risk of corrosion before 50 years.

### Climate

Wet climates promote corrosion in steel more than drier climates. In general, western Washington has the greatest potential for exposure to moisture in PCCP. Most of eastern Washington is considerably drier, experiencing more snow but less rainfall and less overall moisture.

### Corrosion

PCCP directly adjacent to salt water has a high-risk exposure to corrosive salts. Fortunately, little PCCP has this type of exposure in Washington State. The greatest exposure to corrosive salts will be in locations where the highway is regularly treated with salts/corrosive agents during the winter months. Mountain passes, particularly those with “clear pavement” requirements (wherein Maintenance maintains the highway in a snow/ice free condition) will have the greatest exposure.

## Traffic Loading

Trucks present the greatest loading risk for load transfer between adjacent PCCP panels. Truck lanes (usually Lane 1 (rightmost lane) or Lane 2, depending on the total number of lanes) will have the greatest number of ESALs. Risk of load transfer failure increases with increasing ESALs. Lanes with the greatest truck traffic will need more dowels to ensure efficient load transfer. On multi-lane highways, the travel lanes (Lanes 3, 4 or 5) will typically have much fewer trucks. These lanes can be designed with fewer dowel bars per lane and still reach a 50-year pavement life.

## Dowel Bar Alternatives

### 1. Stainless Steel

- Solid stainless. Solid stainless bars are not recommended at this time due to their high initial cost.
- Stainless steel clad. These bars employ a patented manufacturing process that metallurgically bonds ordinary steel and stainless steel.
- Stainless steel sleeves with an epoxy coated dowel bar insert. These bars have an epoxy-coated bar that is inserted into a thin walled stainless steel tube.

### 2. Low-carbon chromium steel and Zinc Clad

- Low-carbon chromium (ASTM A1035) steel dowel bars. These bars are high chromium but below the threshold to be classified as stainless. In addition, these bars have a dual phase steel microstructure that resists corrosion. Currently patented and manufactured by MMFX Steel Corporation (USA).
- Zinc clad dowel bar supplied by Jarden Zinc Products. This dowel bar is produced by mechanically bonding a solid zinc strip to a standard steel dowel bar. The zinc layer provides two-fold protection: (1) surface barrier to minimize chloride attack and (2) cathodic protection.

### 3. Epoxy Coated

- Epoxy coated. Traditional black steel bars with epoxy coating (ASTM A 934)

## Application of Dowel Bar Type Selection

### 1. New Mainline Construction

The only Dowel Bar Alternatives allowed under new construction are stainless steel alternates, low-carbon chromium steel (ASTM A1035) and Zinc Clad.

Dowel Bar Spacing:

- Truck lanes (lanes 1 and 2 in multi-lane highways): Eleven dowel bars per joint, first dowel bar is located 12 inches from lane edge and spaced on 12 inch centers.
- Non-truck lanes (Lanes 3, 4 or 5 in multi-lane highways): Eight dowel bars per joint (four in each wheel path), first and last dowel bar is located 12 inches from lane edge and spaced on 12 inch centers.
- Dowels shall be used for the portion of widened lanes starting 1.0 foot from the panel shoulder edge.
- HOV lanes: Eight dowel bars per joint (four in each wheel path), first and last dowel bar is located 12 inches from lane edge and spaced on 12 inch centers.

Note: The design for HOV lanes assumes these will remain as HOV lanes. The designer/engineer of record should carefully examine the potential future use of the HOV lanes to estimate the risk of this lane being converted to use by truck traffic. If there is a significant risk of the HOV lane being converted to a truck traffic lane, then the eleven dowel bars per joint configuration should be used.



- Widened truck or outside lanes: Where 14 foot wide panels are used (12 foot land and 2 foot widened shoulder). Dowels are required for the widened shoulder located 12 inches from lane edge and spaced on 12 inch centers.
- Concrete Intersections: Eight dowels per joint, four in each wheel path, first and last dowel bar is located 12 inches from lane edge and spaced on 12 inch centers.

## 2. PCCP Intersections and Roundabouts:

The only Dowel Bar Alternatives allowed under new construction are stainless steel alternates, low-carbon chromium steel and zinc clad.

Dowel Bar Spacing:

- Roundabouts and signalized intersections: First dowel bar is located 12 inches from lane edge and spaced on 12 inch centers. Dowel bars are required for both the major and minor legs of the intersection for the intersection square. Tie bars are sufficient for longitudinal joints for the major and minor legs.
- Roundabout truck aprons: First dowel bar is located 12 inches from lane edge and spaced on 12 inch centers.

## 3. Dowel Bar Retrofit (DBR) and Panel Replacement projects:

Dowel Bar Alternatives: Stainless steel alternatives, low-carbon chromium steel, zinc clad and epoxy coated (ASTM A1078 Type 2)

- DBR projects are projected to have useful lives of about 15 years, reducing the need for corrosion resistant dowel bars. Any of the dowel bar alternatives may be used. Dowel bar spacing remains three bars per wheel path regardless of the dowel type.
- Panel replacement projects may use any of the dowel bar alternatives.

## 4. Dowel Bar Specifications

The WSDOT Standard Specifications include the current dowel bar specifications:

- Section 5-01 - Cement Concrete Pavement Rehabilitation (Requirements)
- Section 5-05 - Cement Concrete Pavement (Requirements)
- Section 9-07.5 - Dowel Bars (Materials)



## APPENDIX 2 – FROST DEPTH CONTOUR MAPS

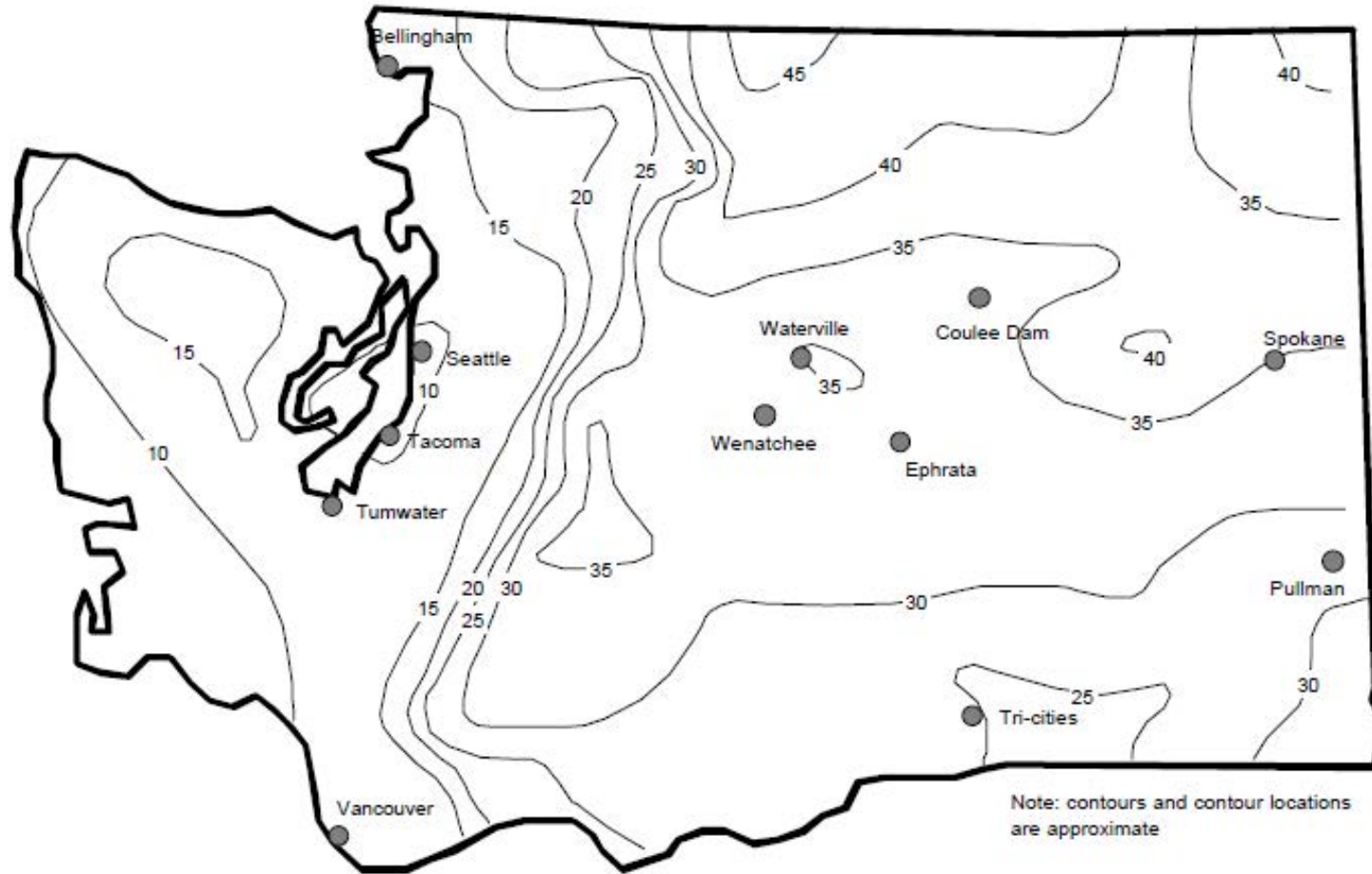

Figure A2.1. Expected depth of freeze (inches) for fine grained soil corresponding to design freezing index (dry density = 100 pcf, wc = 20%)

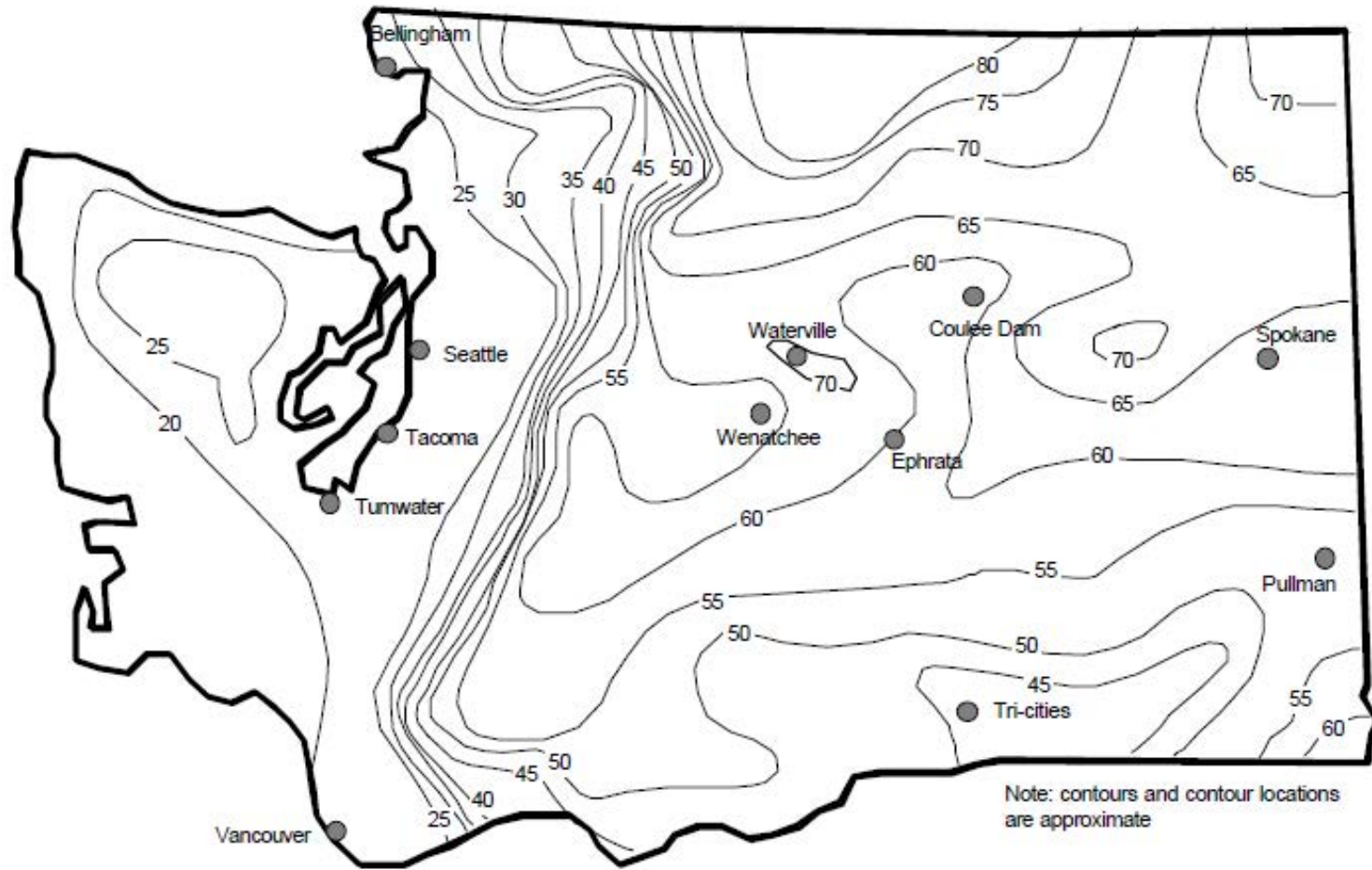

Figure A2.2. Expected depth of freeze (inches) for coarse grained soil corresponding to design freezing index (dry density = 130 pcf, wc = 5%)

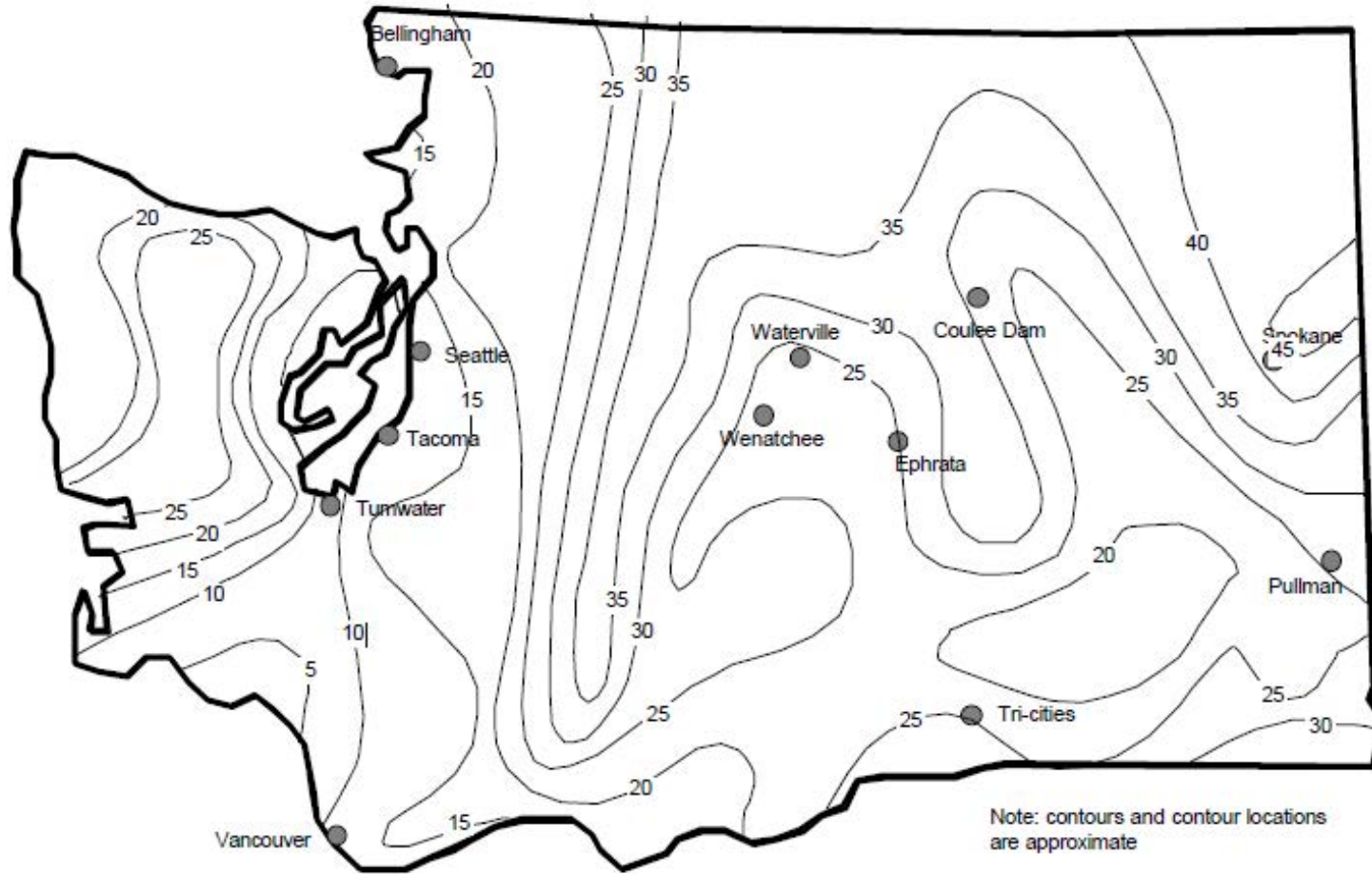

Figure A2.3. Expected depth of freeze (inches) based on field measurements during the winters of 1949 and 1950.



## APPENDIX 3 – PAVEMENT TYPE SELECTION CRITERIA

The information presented in Appendix 3 is intended as a guide for determining the pavement type selection for individual projects. Pavement type selection is a three-part process which includes a pavement design analysis, life cycle cost analysis and evaluation of project specific details. Each of the following section provides examples and discussion necessary to prepare the final pavement type selection determination.

### Pavement Design Analysis

The pavement design should be performed first, since the results may preclude the need to continue with the remainder of the pavement type selection process (life cycle cost analysis and project specific details).

The pavement design analysis includes the review and analysis of the following: subgrade competency, traffic analysis, materials, climate/drainage, environment, construction considerations, and any other pavement design factors.

#### 1. Subgrade Competency

This is the only “go/no go” decision to be made under the pavement design analysis. HMA tends to perform better in situations where long-term settlement is expected. If the engineering evaluation of the subgrade concludes the presence of peat or organic silts or the potential for long-term settlement that exceeds two or more inches, then the pavement type selection is complete and HMA is the selected pavement type. If the engineering evaluation of the subgrade concludes that either pavement type is viable, then the pavement type selection process proceeds to the next step.

#### 2. Classification for Pavement Design

Pavements can be divided into different traffic classes depending on light to heavy traffic. HMA and PCCP can be designed to accommodate these wide traffic ranges. For each of the pavement classes, traffic is quantified according to the number of ESALs. Based on the traffic volume and traffic growth rate, the design traffic loading can be estimated over the structural design period or the analysis period. The design traffic loading determines the pavement thickness needed to support the traffic loading over the structural design period.

Correctly estimating design traffic is crucial to selecting an appropriate pavement type. To calculate the total design traffic per lane that a pavement will carry over its structural design life, it is necessary to estimate present traffic loading. To estimate future traffic loadings, traffic growth rates should be used. Depending on the roadway segment’s importance, conducting a sensitivity analysis to compare growth rates and the impact of the growth rate on pavement thickness may be worthwhile.

#### 3. Materials

Selecting materials for a road pavement design is determined by the availability of suitable materials, environmental considerations, construction methods, economics, and previous performance. To select the materials that best suit the conditions, these factors must be evaluated during the design to ensure a whole-life cycle strategy.

##### 3.1. Availability and Performance

Most road construction materials have been classified and specifications prepared for each of the material classes. Every road pavement, independent of its type and applied materials, is subjected to certain traffic loads and environmental factors. These factors create various deterioration modes under in-service conditions. Deterioration modes and the pavement’s susceptibility to various deteriorating factors depend

on the type of pavement and materials applied. Table A3.1 shows the pavement deterioration modes for HMA and PCCP.

**Table A3.1 Pavement Deterioration Modes**

HMA Pavements	PCCP
<ul style="list-style-type: none"> <li>▪ Surface deterioration                             <ul style="list-style-type: none"> <li>– Decrease in friction</li> <li>– Rutting</li> <li>– Surface cracking</li> <li>– Raveling (stripping)</li> <li>– Roughness</li> <li>– Studded tire wear</li> </ul> </li> <li>▪ Structural deterioration                             <ul style="list-style-type: none"> <li>– Base and subgrade rutting</li> <li>– Fatigue cracking</li> <li>– Reflective cracking</li> </ul> </li> </ul>	<ul style="list-style-type: none"> <li>▪ Surface deterioration                             <ul style="list-style-type: none"> <li>– Decrease in friction</li> <li>– Surface cracking</li> <li>– Curling and warping</li> <li>– Joint raveling</li> <li>– Roughness</li> <li>– Studded tire wear</li> </ul> </li> <li>▪ Structural deterioration                             <ul style="list-style-type: none"> <li>– Cracking</li> <li>– Pumping</li> <li>– Faulting</li> </ul> </li> </ul>

Pavement surface defects may only require surface course maintenance or rehabilitation. Structural deterioration is a defect of the whole pavement structure and treating it may require more extensive pavement rehabilitation. Knowing the difference between these two types of deterioration is important to maintaining and properly understanding pavement durability (or pavement life).

Past performance with a particular material should be considered in tandem with applicable traffic and environmental factors. The performance of similar pavements or materials under similar circumstances should also be considered. Information from pre-existing designs, material tests, and pavement management data can help characterize a specific material’s suitability for pavement applications.

WSDOT’s experience has been that all pavement types are affected by studded tire wear (see Figures A3.1 and A3.2). The abrasion on pavement surfaces caused by studded tires, wears down the pavement surface at a much greater rate than any other pavement/tire interaction. The same can be said for open graded surface courses and wear due to buses with snow chains. Significant surface deterioration has occurred in as little as 4 to 6 years on HMA and 10 to 15 years on PCCP. For the pavement type selection process, this implies that future rehabilitation timing may be reduced for each pavement type due to the damaging effect of studded tires and should be considered in the analysis until such a time that studded tire use is prohibited.



**Figure A3.1. Studded Tire Wear on PCCP**



**Figure A3.2. Studded Tire Wear on HMA**



## WSDOT Pavement Policy

### 3.2. Recycling

To enhance sustainable development, consider using recycled materials in roadway construction. Future rehabilitation or maintenance treatments, if applicable, should incorporate recycled materials whenever possible.

### 3.3. HMA Mixes

WSDOT has used four basic types of dense graded mixes which are described by the nominal maximum aggregate size (NMAS). These are 3/8-inch, 1/2-inch, 3/4-inch, and 1-inch. Recent use has almost entirely consisted of 3/8-inch, 1/2-inch mixes. Binder selection for HMA mixes is based on the PG grading system and the following criteria:

- Base PG grades with no adjustment for traffic speed or ESAL level
  - Western Washington: PG 58H-22
  - Eastern Washington: PG 64H-28
  - PG 58S-22 or PG64S-28 may be used on non-WSDOT projects
- Adjustment for slow traffic (15 to 40 mph) or moderate loading (7 to 20 M ESALs)
  - Western Washington: PG 58H-22
  - Eastern Washington: PG 64H-28
- Adjustment for standing traffic (less than 15 mph) and/or high loading (>20 M ESALs)
  - Western Washington: PG 58V-22
  - Eastern Washington: PG 64V-28

## 4. Climate/Drainage

Both surface runoff and subsurface water control must be considered. Effective drainage design prevents the pavement structure from becoming saturated. Effective drainage is essential for proper pavement performance and is assumed in the structural design procedure. WSDOT rarely includes open graded drainage layers in its pavement structures. This does occur only for extreme subsurface drainage issues.

## 5. Pavement Design

Pavement design shall be conducted in accordance with the WSDOT Pavement Policy. All pavement designs, rehabilitation strategies, and rehabilitation timing must be submitted, for approval, to the Pavement Design Engineer at the State Pavement Office.

### 5.1. Additional PCCP Consideration

WSDOT has demonstrated that the PCCP constructed in the late 1950s through the 1960s are able to obtain a 50-year or more pavement life as long as joint faulting can be overcome. The ability to provide adequate joint design to minimize joint faulting is addressed by requiring the use of non-erodible bases and dowel bars (1-1/2 inch diameter by 18 inch length) at every transverse joint. The use of epoxy-coated dowel bars, both locally and nationally, does not necessarily ensure that a 50-year performance life will be obtained. Dowel bar specifications require the use of corrosion resistant dowel bars (stainless steel alternatives, low-carbon chromium steel (ASTM A1035) or Zinc clad) on all newly constructed PCCP (Appendix 1). Rehabilitation of PCCP will potentially require diamond grinding following 20 to 30 years of traffic to address studded tire wear.

### 5.2. Additional HMA Considerations

For heavily trafficked roadways (primarily the interstate and principal arterials), the pavement thickness should be designed to such a depth that future roadway reconstruction is not necessary. The pavement thickness should be designed for 50 years so that traffic will not generate significant bottom up (fatigue) cracking. Future mill and fill or HMA overlays will be required to address surface distress (rutting or top down cracking) and aging of the HMA surface.

### 5.3. Effect of Studded Tire Wear.

In the past, WSDOT has increased the PCCP slab thickness by one inch to accommodate future diamond grinding(s). The current PCCP slab thicknesses contained in Table 5.1 includes an additional inch for grinding and adding an additional inch when using the design table is no longer necessary. Studded tire damage is also a concern for HMA pavements. WSDOT has constructed a number of stone matrix asphalt (SMA) pavements, but have had a number of construction related difficulties, such that the ability to determine the impact that a SMA will have on reducing studded tire damage is unknown. In the life cycle cost analysis, the accelerated wear on HMA pavements will be incorporated through a shorter performance period on future overlays (but only as supported by Pavement Management data).

## 6. Construction Considerations

Pavement construction issues are an important component of the selection of pavement type. These issues can include:

- Pavement thickness constraints. Consider the impact of utilities below the pavement and overhead clearances may have on limiting the layer thickness and type, and/or limit future overlay thickness.
- Effects on detours, bypasses, and alternate routes. Consider the geometric and structural capacity of detours, bypasses and alternate routes to accommodate rerouted traffic.
- Effects of underground pipes and services on performance. Determine the impact of existing utilities and future utility upgrades on initial and future rehabilitation treatments.
- Anticipated future improvements and upgrades. Consider if the pavement type restricts or minimizes the ability to efficiently and cost effectively upgrade and/or improve the roadway width, geometry, structural support, etc.
- Impact on maintenance operations, including winter maintenance. Will the selected pavement type have impacts due to freeze-thaw (surface and full-depth) or snow and ice removal?
- Grades, curvature, and unique loadings (slow-moving vehicles and starting and stopping). How will steep grades, curvature and unique loadings impact pavement performance? Slow moving vehicles will generate increased strain levels in the HMA pavement structure and these strains can significantly impact pavement performance (i.e. rutting and cracking).
- A schedule analysis may need to be conducted to determine critical construction features (haul truck access, traffic control constraints – road closures, etc.) and their impact on the project. This should also include staging analysis for multiple projects within the project corridor (to ensure that alternate routes are free of traffic delay due to construction activities). The Construction Analysis for Pavement Rehabilitation Strategies [R3](#) software is useful in determining construction impacts and duration.

## 7. Other Factors

Evaluate other factors that are unique to the project or corridor.

## Life Cycle Cost Analysis

Life cycle cost analysis provides a useful tool to assist in the pavement type selection. Only differential factors should be considered. The alternative resulting in the lowest net present value or annualized cost over a given analysis period is considered the most cost efficient.

Life cycle costs refer to all costs that are involved with the construction, maintenance, rehabilitation and associated user impacts of a pavement over a given analysis period. Life cycle cost analysis is an economic comparison of all feasible construction or rehabilitation alternatives, evaluated over the same analysis period. A feasible alternative meets the required constraints, such as geometric alignment, construction period, traffic flow conditions, clearances, right-of-way, etc. (FHWA, 1987). At a minimum, one HMA and one PCCP alternative should be evaluated. The total cost (initial construction, maintenance, rehabilitation, and user costs) of each design alternative can be compared based on the present value or equivalent uniform annual cost.

## WSDOT Pavement Policy

The life cycle cost analysis is conducted using the FHWA life cycle cost analysis software, which is available through the State Pavement Office.

The Federal Highway Administration's policy on life cycle cost analysis "is that it is a decision support tool, and the results of the life cycle cost analysis are not decisions in and of themselves. The logical analytical evaluation framework that life cycle cost analysis fosters is as important as the life cycle cost analysis results themselves." (FHWA, 1998).

Net present value is the economic efficiency indicator of choice (FHWA, 1998). The annualized method is appropriate, but should be derived from the net present value. Computation of benefit/cost ratios is generally not recommended because of the difficulty in sorting out costs and benefits for use in the benefit/cost ratios (FHWA, 1998).

Future costs should be estimated in constant dollars and discounted to the present using a discount rate. The use of constant dollars and discount rates eliminates the need to include an inflation factor for future costs.

### 1. Net Present Value

The present value method is an economic method that involves the conversion of all of the present and future expenses to a base of today's costs (Dell'Isola, 1981). The totals of the present value costs are then compared one with another. The general form of the present value equation is as follows:

$$NPV = F \frac{1}{(1+i)^n}$$

Where,

NPV = Net Present Value

F = Future sum of money at the end of n years

n = Number of years

i = Discount rate

### 2. Annualized Method

The annualized method is an economic procedure that requires converting all of the present and future expenditures to a uniform annual cost (Dell'Isola, 1981). This method reduces each alternative to a common base of a uniform annual cost. The costs are equated into uniform annual costs through the use of an appropriate discount rate (Kleskovic, 1990). Recurring costs, such as annual maintenance, are already expressed as annual costs. A given future expenditure, such as a pavement overlay, must first be converted to its present value before calculating its annualized cost. The general form of the Annualized cost equation is as follows:

$$A = PV \frac{i(1+i)^n}{(1+i)^n - 1}$$

Where,

A = Annual cost

PV = Present Value

n = Number of years

i = Discount rate

### 3. Economic Analysis

The costs to be included in the analysis are those incurred to plan, work on and maintain the pavement during its useful life. All costs that can be attributed to the alternative and that differ from one alternative to another must be taken into account. These include costs to the highway agencies and user costs.

### 3.1. Performance Period

As a pavement ages, its condition gradually deteriorates to the point where some type of rehabilitation treatment is necessary. The timing between rehabilitation treatments is defined as the performance life. An example of this is illustrated in Figure A3.3. Performance life for the initial pavement design and subsequent rehabilitation activities has a major impact on life cycle cost analysis results (FHWA, 1987).

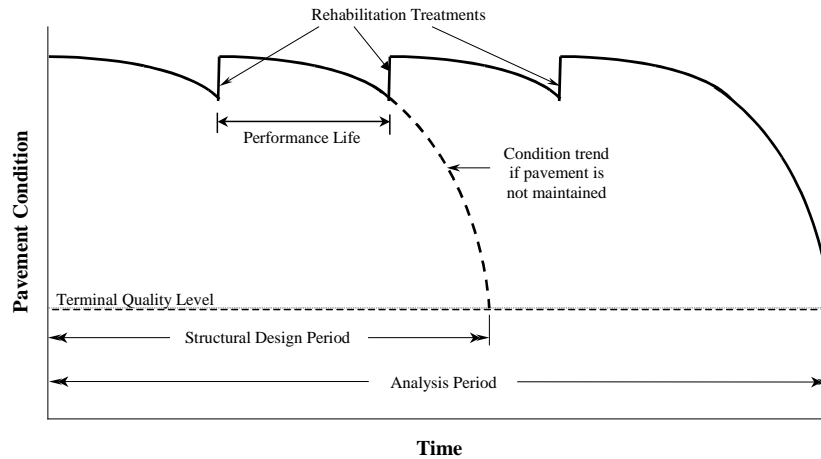

**Figure A3.3. Example of Pavement Performance Life**

When available, the performance life of the various rehabilitation alternatives should be determined based on past performance history. In these cases, the WSPMS provides history on past pavement performance lives. In instances where the anticipated performance life is not well established (i.e., due to improved engineering and technologies), selection of the performance life will be coordinated and concurred upon by the State Pavement Office.

### 3.2. Initial Construction Costs

Unit costs vary according to location, the availability of materials, the scope of the project and any applicable standards. They can be estimated based on previous experiences, generally by averaging the bids submitted for recent projects of similar scope. Typical item costs can be located in bid item tabulations. The bid item costs may need to be adjusted according to local availability and work constraints. Mobilization, engineering and contingencies, and preliminary engineering can be excluded (sales tax should be included) for the initial construction cost estimate, since these costs are similar for HMA and PCCP.

### 3.3. Maintenance and Rehabilitation Costs

The type and frequency of future maintenance and rehabilitation operations vary according to the pavement type being considered. Knowing how a particular pavement type performed in the past is a valuable guide in predicting future performance (Penn DOT, 2001). The WSPMS should be reviewed for past performance of rehabilitation and maintenance schedules. Costs must always be determined as realistically and accurately as possible based on local context and specific project features.

When calculating the rehabilitation costs, include the cost of pavement resurfacing or PCCP rehabilitation, planning or diamond grinding, shoulders, pavement repair, drainage and guardrail adjustments, maintenance and protection of traffic, etc. Mobilization, engineering, contingencies, preliminary engineering, and sales tax should be included in all rehabilitation costs if they were included in the initial construction cost.

Construction duration should reflect the actual construction time that is required for each pavement type. Construction durations should consider improvements, proposals or innovative contracting procedures in construction processes.

If a difference exists in routine maintenance costs between the various alternatives, these costs should be included in the life cycle cost analysis.

Table A3.2 contains a probable scenario corresponding to average traffic and climate conditions, assuming that state-of-the-art practices have been followed during construction and that maintenance and rehabilitation projects are carried out efficiently and on schedule.

**Table A3.2. Rehabilitation Scenario for HMA and PCCP**

Year	HMA Pavement	PCCP
0	Construction or reconstruction	Construction or reconstruction
15	0.15' mill and HMA overlay	
20		Diamond grinding
30	0.15' HMA overlay	
40		Diamond grinding
45	0.15' mill and HMA overlay	
50	Salvage value (if applicable)	Salvage value (if applicable)

### 3.4. Salvage Value

Salvage value is the asset value at the end of the analysis period. The difference between the salvage values of the various alternatives for a project can be small, because discounting can considerably reduce this value, but the size of this reduction is influenced by the actual discount rate chosen. As for the value assigned to the pavement materials, or terminal value, predicting the proportion of recovery or recycling of these materials on-site at the end of the analysis period is uncertain.

If an alternative has reached its full life cycle at the end of the analysis period, it is generally considered to have no remaining salvage value. If it has not completed a life cycle, it is given a salvage value, which is usually determined by multiplying the last construction or rehabilitation cost, by the ratio of the remaining expected life cycle to the total expected life.

$$\text{Salvage Value} = \text{CC} \times \frac{\text{ERL}}{\text{TEL}}$$

Where,

CC = Last construction or rehabilitation project costs

ERL = Expected remaining life of the last construction or rehabilitation project

TEL = Total expected life of the last construction or rehabilitation project

### 3.5. User Costs

It is difficult to determine whether or not one rehabilitation alternative results in a higher vehicle operating cost than another. Therefore, the user costs associated with each of the rehabilitation alternatives shall be determined using only costs associated with user delay. This shall be based on the construction periods and the traffic volumes that are affected by each of the rehabilitation alternatives.

Several studies have been performed that associate cost with the amount of time the user is delayed through a construction project. The method used is not as important as using the same method for each of the alternatives.

The costs associated with user delays are estimated only if the effects on traffic differ among the alternatives being analyzed. For future rehabilitation work, user costs associated with delays can be substantial for heavily travelled roadways, especially when work is frequent.

While there are several different sources for the dollar value of time delay, the recommended mean values and ranges for the value of time (in 2006 dollars) shown in Table A3.3, are reasonable.

**Table A3.3. Recommended Dollar Values per Vehicle Hour of Delay (FHWA, 1998) (adjusted to 2015 dollars)**

Vehicle Class	Value Per Vehicle Hour	
	Value	Range
Passenger Vehicles	\$17.34	\$15 to \$20
Single-Unit Trucks	\$27.90	\$26 to \$30
Combination Trucks	\$33.93	\$32 to \$36

3.6. Other Costs

Surfacing types and characteristics influence the noise emitted on tire-to-pavement contact. If construction of a noise attenuation structure is planned, the cost of that structure must be included in the treatment costs of the alternative being analyzed. The issue of safety can be addressed similarly.

3.7. Discount Rate

"In a life cycle cost analysis, a discount rate is needed to compare costs occurring at different points in time. The discount rate reduces the impact of future costs on the analysis, reflecting the fact that money has a time value" (Peterson, 1985). The discount rate is defined as the difference between the market interest rate and inflation, using constant dollars.

Table A3.4. Shows recent trends in the real treasury interest rates for various analysis periods published in the annual updates to OMB Circular A-94 (OMB).

For all life cycle cost analysis, a discount rate of four percent shall be used as is supported by the long-term rates shown in Table A3.4.

**Table A3.4. Real Treasury Interest Rates (OMB)**

Year	3-Year	5-Year	7-Year	10-Year	30-Year
1979	2.8	3.4	4.1	4.6	5.4
1980	2.1	2.4	2.9	3.3	3.7
1981	3.6	3.9	4.3	4.4	4.8
1982	6.1	7.1	7.5	7.8	7.9
1983	4.2	4.7	5.0	5.3	5.6
1984	5.0	5.4	5.7	6.1	6.4
1985	5.9	6.5	6.8	7.1	7.4
1986	4.6	5.1	5.6	5.9	6.7
1987	2.8	3.1	3.5	3.8	4.4
1988	3.5	4.2	4.7	5.1	5.6
1989	4.1	4.8	5.3	5.8	6.1
1990	3.2	3.6	3.9	4.2	4.6
1991	3.2	3.5	3.7	3.9	4.2

1992	2.7	3.1	3.3	3.6	3.8
1993	3.1	3.6	3.9	4.3	4.5
1994	2.1	2.3	2.5	2.7	2.8
1995	4.2	4.5	4.6	4.8	4.9
1996	2.6	2.7	2.8	2.8	3.0
1997	3.2	3.3	3.4	3.5	3.6
1998	3.4	3.5	3.5	3.6	3.8
1999	2.6	2.7	2.7	2.7	2.9
2000	3.8	3.9	4.0	4.0	4.2
2001	3.2	3.2	3.2	3.2	3.2
2002	2.1	2.8	3.0	3.1	3.9
2003	1.6	1.9	2.2	2.5	3.2
2004	1.6	2.1	2.4	2.8	3.5
2005	1.7	2.0	2.3	2.5	3.1
2006	2.5	2.6	2.7	2.8	3.0
2007	2.5	2.6	2.7	2.8	3.0
2008	2.1	2.3	2.4	2.6	2.8
2009	0.9	1.6	1.9	2.4	2.7
2010	0.9	1.6	1.9	2.2	2.7
2011	0.0	0.4	0.8	1.3	2.3
2012	0.0	0.4	0.7	1.1	2.0
2013	-1.4	-0.8	-0.4	0.1	1.1
2014	-0.7	0.0	0.5	1.0	1.9
2015	0.1	0.4	0.7	0.9	1.4
2016	0.3	0.6	0.8	1.0	1.5
2017	-0.5	-0.3	0.0	0.1	0.7
Average					3.8

### 3.8. Analysis Period

The analysis period is the time period used for comparing design alternatives. An analysis period may contain several maintenance and rehabilitation activities during the life cycle of the pavement being evaluated (Peterson, 1985). In general, the recommended analysis period coincides with the useful life of the most durable alternative. WSDOT's recommended analysis period for all pavement types is 50 years.

### 3.9. Risk Analysis

The deterministic approach to life cycle costs involves the selection of discrete input values for the initial construction costs, routine maintenance and rehabilitation costs, the timing of each of these costs, and the discount rate. These values are then used to calculate a discrete single value for the present value of the specified project. The deterministic approach applies procedures and techniques without regard for the variability of inputs. An example of the deterministic approach is shown in below.

## WSDOT Pavement Policy

Initial Cost = \$1,000,000

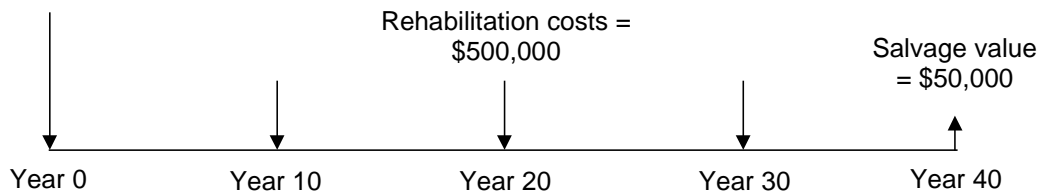

Discount rate = 4 percent

$$\begin{aligned} PW &= \$1,000,000 + \frac{\$500,000}{(1.04)^{10}} + \frac{\$500,000}{(1.04)^{20}} + \frac{\$500,000}{(1.04)^{30}} - \frac{\$50,000}{(1.04)^{40}} \\ &= \$1,709,720 \end{aligned}$$

The deterministic approach is a viable method for determining life cycle costs; however, life cycle cost analysis contains several possible sources of uncertainty. In certain cases, the uncertainty factors may be sizeable enough to affect the ranking of the alternatives. To obtain more credible results, a systematic evaluation of risk should always be carried out. The primary disadvantage of the deterministic approach is that it does not account for the input parameter variability.

The concept of risk comes from the uncertainty associated with future events – the inability to know what the future will bring in response to a given action today (FHWA, 1998). Risk analysis is concerned with three basic questions (FHWA, 1998):

1. What can happen?
2. How likely is it to happen?
3. What are the consequences of it happening?

Risk analysis answers these questions by combining probabilistic descriptions of uncertain input parameters with computer simulation to characterize the risk associated with future outcomes (FHWA, 1998). It exposes areas of uncertainty typically hidden in the traditional deterministic approach to life cycle cost analysis, and it allows the decision maker to weigh the probability of an outcome actually occurring (FHWA, 1998).

The two most commonly used methods of assessing the risk are probabilistic analysis and sensitivity analysis. The probabilistic approach combines probability descriptions of analysis inputs to generate the entire range of outcomes as well as the likelihood of occurrence. Probabilistic analysis represents uncertainties more realistically than does a sensitivity analysis. Sensitivity analysis assigns the same weighting to all extreme or mean values, whereas probabilistic analysis assigns the lowest probability to extreme values. A probabilistic analysis is advocated, but if this is not possible, a sensitivity analysis at the very least should be carried out.

### 3.10. Probabilistic Analysis

The probabilistic approach takes into account the uncertainty of the variables used as inputs in the life cycle cost analysis. The probability distribution is selected for each input variable, which are then used to generate the entire range of outcomes and the likelihood of occurrences for both the associated costs and the performance life. The procedure often used to apply a probability distribution is a “Monte Carlo Simulation”. The Monte Carlo Simulation is a computerized procedure that takes each input variable, assigns a range of values (using the mean and standard deviation of the input variable), and runs multiple combinations of all inputs and ranges to generate a life cycle cost probability distribution. Using the



probabilistic approach allows for the ability of determining the variability or “spread” of the life cycle cost distributions and determining which alternative has the lower associated risk (see Figure A3.4).

WSDOT input values for the probabilistic analysis are contained in Appendix 5. An example of a probabilistic analysis is included in Appendix 6.

By performing the Monte Carlo computer simulation, thousands, even tens of thousands of samples are randomly drawn from each input distribution to calculate a separate what-if scenario (FHWA, 1998). Risk analysis results are presented in the form of a probability distribution that describes the range of possible outcomes along with a probability weighting of occurrence (FHWA, 1998). With this information, the decision maker knows not only the full range of possible values, but also the relative probability of any particular outcome actually occurring (FHWA, 1998).

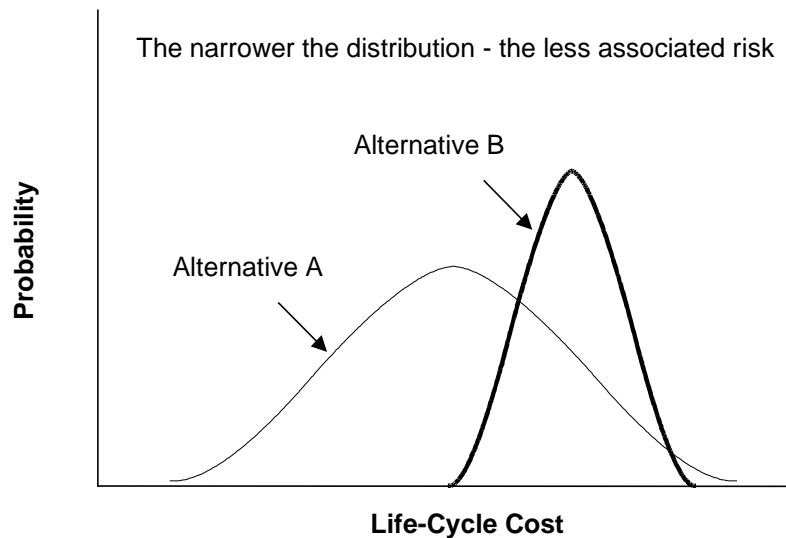

**Figure A3.4. Probability Distribution**

### 3.11. Sensitivity Analysis

Sensitivity analysis is a technique used to determine the influence of major input assumptions, projections, and estimates on life cycle cost analysis results. In a sensitivity analysis, major input values are varied (either within some percentage of the initial value or over a range of values) while all other input values remain constant and the amount of change in results is noted (FHWA, 1998).

An example of a sensitivity analysis is shown below.

- Two pavement design strategies with discount rates that vary from two to six percent over a 35-year analysis period will be described.
- Figure A3.5 summarizes Tables A3.6 and A3.7 show the comparison of net present value at the various discount rates. For this example, Alternative 1 is more expensive at discount rates of five percent and lower, while Alternative 2 is more expensive at discount rates six percent and above.

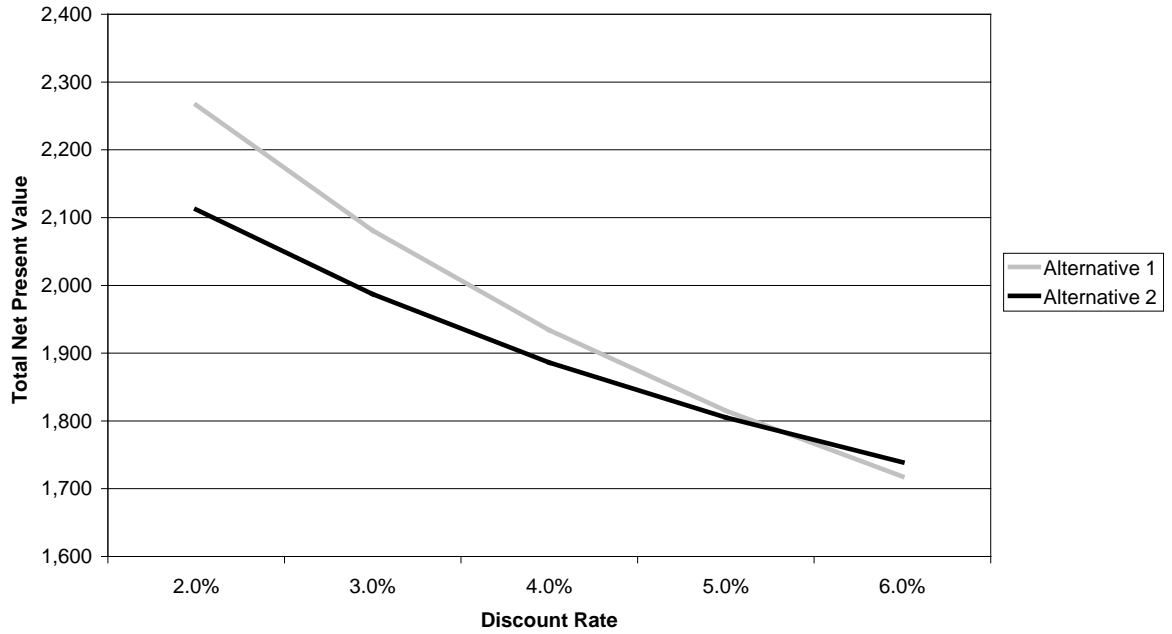

**Figure A3.5. Sensitivity of Net Present Value to Discount Rate**

**Table A3.6. Sensitivity Analysis – Alternative 1 (FHWA, 1998)**

Activity	Year	Cost	Net Present Value				
			2.0%	3.0%	4.0%	5.0%	6.0%
Construction	0	975	975	975	975	975	975
User Cost	0	200	200	200	200	200	200
Rehab #1	10	200	164	149	135	123	112
User Cost #1	10	269	220	200	182	165	150
Rehab #2	20	200	135	111	91	75	62
User Cost #2	20	361	243	200	165	136	113
Rehab #3	30	200	110	82	62	46	35
User Cost #3	30	485	268	200	150	112	85
Salvage	35	-100	-50	-36	-25	-18	-13
TOTAL NPV			2,266	2,081	1,934	1,815	1,718

**Table A3.7. Sensitivity Analysis – Alternative 2 (FHWA, 1998)**

Activity	Year	Cost	Net Present Value				
			2.0%	3.0%	4.0%	5.0%	6.0%
Construction	0	1,100	1,100	1,100	1,100	1,100	1,100
User Cost	0	300	300	300	300	300	300
Rehab #1	15	325	241	209	180	156	136
User Cost #1	15	269	200	173	139	129	112
Rehab #2	30	325	179	134	100	75	57
User Cost #2	30	361	199	149	111	84	63
Salvage	35	-217	-108	-77	-55	-39	-28
Total NPV			2,112	1,987	1,886	1,805	1,739

A primary drawback of the sensitivity analysis is that the analysis gives equal weight to any input value assumptions, regardless of the likelihood of occurring (FHWA, 1998). In other words, the extreme values (best case and worst case) are given the same likelihood of occurrence as the expected value, which is not realistic (FHWA, 1998).

### Project Specific Details

After completing the pavement design analysis and the life cycle cost analysis, evaluation of project specific details must be identified when there are two or more viable alternatives. Finding the HMA and PCCP alternatives to be approximately equivalent, in regards to life cycle cost, the Region must provide project specific details that support the selected pavement type. The fact that these are not easily quantified does not lessen their importance; in fact these factors may be the overriding reason for making the final pavement type selection. These decision factors should be carefully reviewed and considered, by WSDOT engineers most knowledgeable of the corridor and the surrounding environment.

When reporting the project specific details for pavement type selection, the Region must not use reasoning or examples that have already been taken into account within the pavement design analysis or the life cycle cost analysis. Examples of reasoning that should not be presented in the project specific details include:

1. Availability of funds for the more expensive pavement type.
2. Supporting the choice for pavement type based on ESALs or average daily traffic (ADT) that has already accounted for in the life cycle cost analysis.
3. Supporting the choice for pavement type based on user delay that has already accounted for in the life cycle cost analysis.

The Region should include the engineering reasons that suggest the selection of one pavement type over another, given that their life cycle costs are approximately equivalent. Not all factors will come into play on every project, nor will all factors have equal weight or importance on each project. Refer to Appendix 7 for a listing of these considerations.



## APPENDIX 4 – EXAMPLE PAVEMENT TYPE SELECTION REPORT



Memorandum

June 8, 2009

TO: L. Laird  
Chief Engineer  
Assistant Secretary Engineering and Regional Operations

FROM: Jeff Uhlmeyer  
(360) 709-5485

SUBJECT: SR 704, MP 0.00 to MP 6.00 VIC  
Cross Base Highway  
**Pavement Type Selection Protocol Analysis**

Attached for your signature is the Pavement Type Selection Committee approval form for SR 704, Cross Base Highway. Please return the completed approval to the State Materials Lab.

This approval is according to the procedure for activating the Pavement Type Selection Committee. The procedure is described in the attached June 29, 2004 letter (copy included for each committee member) approved by L. Laird. If you need clarification or have comments please call Jeff Uhlmeyer at 709-5485.

JU:ctk  
JU

cc: Jay Alexander, Director Capital Program Development & Management, 47325  
Pasco Bakotich, State Design Engineer, 47329  
Chris Christopher, State Construction Engineer, 47354  
Kevin Dayton, Olympic Region Administrator, 47440



## Memorandum

June 8, 2009

TO: L. Laird, 47315  
Chief Engineer  
Assistant Secretary of Engineering and Regional Operations

FROM: Chris Christopher, 47354  
State Construction Engineer

SUBJECT: Pavement Type Selection

When the pavement type selection has been completed and forwarded to the State Materials Laboratory, the Pavement Division will formulate the Pavement Type Selection Committee (referred to as the Committee) Approval Letter and request that each member of the Committee sign and forward the letter on to the next member. The Committee is not required to convene if the life cycle cost analysis between the alternatives is greater than 15 percent and the recommendations are acceptable to both the Region and the State Materials Laboratory. The Approval Letter shall provide the necessary documentation that supports the Committee's selection of the pavement type.

Projects to be reviewed shall be distributed to the Committee members for approval (see attached example of Approval Letter). Based on this review and obtaining consensus from the Committee, the Pavement Division will either process the Approval Letter, take appropriate action to obtain consensus, or convene the Committee.

In order to expedite the required time and expended level of effort for the review of pavement type selection projects, the following procedure is recommended:

1. The Committee should convene if the pavement type recommended by the Region is contrary to pavement design and engineering analysis recommendations. The pavement design and engineering analysis recommendations shall be subject to the review of the Pavement Division or any member of the Committee. Under these circumstances it shall be the responsibility of the Pavements Division or the Committee member to formulate, in writing, why the selected pavement type is not appropriate and distribute his/her rationale to all members. If all members agree with the recommendations a meeting will not be necessary, otherwise, the Committee should convene.
2. The Committee should convene at the request of any member.

TEB: jsu



**PAVEMENT TYPE SELECTION**

**SR 704**

**Cross Base Highway**

**MP 0.00 to MP 6.00 Vicinity**

The Pavement Type Selection Committee has completed its review of the pavement type selection for project SR 704 Cross Base Highway located in central Pierce County.

This project consists of constructing a new six-mile long East-West divided highway connecting Interstate 5 at Thorne Lane and State Route 7 at 176<sup>th</sup> Street. The proposed roadway section will consist of two Eastbound and two Westbound 12-ft. lanes with 4-ft. inside and 10-ft. outside shoulders. The design allows for the addition of future HOV lanes in the median.

Following the procedure in the Pavement Type Selection Protocol, the analysis indicates the following:

- I. **Pavement Design Analysis.** There are no pavement design issues. Both Hot Mix Asphalt (HMA) and Portland Cement Concrete (PCC) are viable alternatives.
- II. **Life Cycle Cost Analysis.** The HMA cost is 50-53% less than PCC. HMA is the selected option.
- III. **Engineering Analysis.** Not performed. The Life Cycle Cost difference is greater than 15% between the two pavement types.

The Committee based on this analysis approves the use of HMA on this project.

**The Pavement Type Selection Committee**

\_\_\_\_\_  
Chief Engineer  
Assistant Secretary of Engineering and  
Regional Operations

\_\_\_\_\_  
State Design Engineer

\_\_\_\_\_  
State Construction Engineer

\_\_\_\_\_  
Director Capital Program Development and  
Management

\_\_\_\_\_  
Olympic Region Administrator

JU:ck

## **SR 704 - Cross Base Highway**

### **Pavement Type Selection Protocol Analysis**

**October 28, 2005**

**Prepared by:**

Mel Hitzke, PE - Olympic Region Materials Lab  
Terry MacAuley, Olympic Region Materials Lab

**Reviewed by:**

Jeff Uhlmeyer, PE – State Materials Lab – Pavements Division  
Chuck Kinne, PE – State Materials Lab – Pavements Division



## Pavement Type Selection Overview

The purpose of this document is to evaluate and recommend either a hot mix asphalt (HMA) pavement or portland cement concrete (PCC) pavement for SR 704-Cross Base Highway. The Washington State Department of Transportation (WSDOT) Pavement Type Selection Protocol will be used to compare and evaluate these two alternatives. The Protocol requires that a pavement type be selected based on the evaluation of three primary areas: pavement design, life cycle cost and project specific externalities.

## SR 704 Project

The SR 704 Cross Base Highway Project is located in central Pierce County. This project will create a new six-mile long, East-West connection between I-5 at Thorne Lane (MP 123.5) and SR 7 at 176<sup>th</sup> St. (MP 48.3). The proposed multi-lane highway will consist of (4) 12-ft. lanes, 46-ft. wide median, and (2) inside shoulders and 10-ft. outside shoulders. The project is designed to provide for future HOV lanes in the median.

## I. Pavement Design Analysis

### 1. Foundation Analysis and Results

Soils within the project limits are non-plastic medium dense, well graded gravel with sand to poorly graded sand. Based on these favorable soil conditions, both HMA and PCC pavements are viable.

### 2. HMA Design Alternative

The HMA alternative includes 20-ft. of HMA Class  $\frac{1}{2}$ " placed over 0.67-ft. Crushed Surfacing Base Course (CSBC) as shown in Figure A4.1. The inside shoulder is full depth to facilitate the addition of the future HOV lanes (see Appendix 4-A).

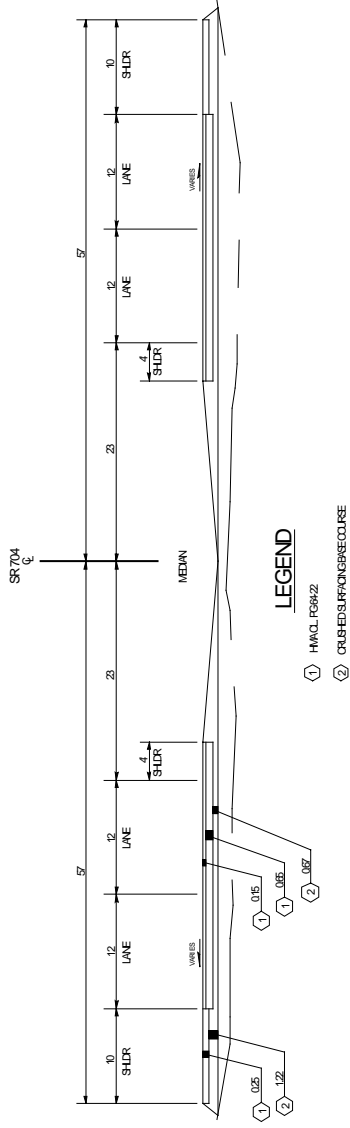

Figure A4.1

### 3. HMA Rehabilitation

A historical analysis of state routes in the vicinity of the proposed project with similar AADT and truck percentage was performed to determine pavement rehabilitation cycles. Based on the WSPMS data a 13-year rehabilitation cycle was selected (see Appendix 4-B, Table A4-B.1).

The rehabilitation cycles are scheduled for 2021, 2034 and 2047. The 2021 and 2047 rehabilitation cycles are full width (edge of paved shoulder (EPS) to EPS) 0.15-ft. HMA overlays. The 2034 rehabilitation is a

WSDOT Pavement Policy

0.15-ft. HMA grind and inlay (Edge of Pavement (EP) to EP) with the fog sealing of shoulders. A summary of the construction and rehabilitations are shown in Table A4.1.

**Table A4.1. HMA Construction and Rehabilitation Summary**

Construction Category	Year	Description
Initial Construction (2008)	0	Construct 2 (12-ft.) lanes in each direction <b>Traveled Lanes and Left Shoulder</b> 0.80-ft. HMA Class 1/2" 0.67-ft. CSBC <b>Right Shoulder</b> 0.25-ft. HMA Class 1/2" 1.22-ft. CSBC
Rehabilitation #1 (2021)	13	Overlay EPS to EPS with 0.15-ft. HMA Class 1/2"
Rehabilitation #2 (2034)	26	Grind & Inlay lanes EP to EP with 0.15-ft. HMA Class 1/2" and fog sealing of shoulders
Rehabilitation #3 (2047)	39	Overlay EPS to EP with 0.15-ft. HMA Class 1/2"

**4. PCC Design Alternative**

The PCC alternative includes a 1.00-ft. thick PCC (with a future diamond grind) over 0.30-ft. HMA base placed over 0.67-ft. CSBC. The PCC is shown in Figure A4.2. Both the inside and outside shoulders would be constructed with 0.35-ft. HMA Class 1/2" placed over 1.25-ft. CSBC. The HMA shoulder section has been increased from 1.25-ft. to 0.35-ft. to allow for section loss from future diamond grinding of the PCC. The additional HMA depth will also provide sufficient support when a temporary traffic shift is required for the addition of HOV lanes (see Appendix 4-A).

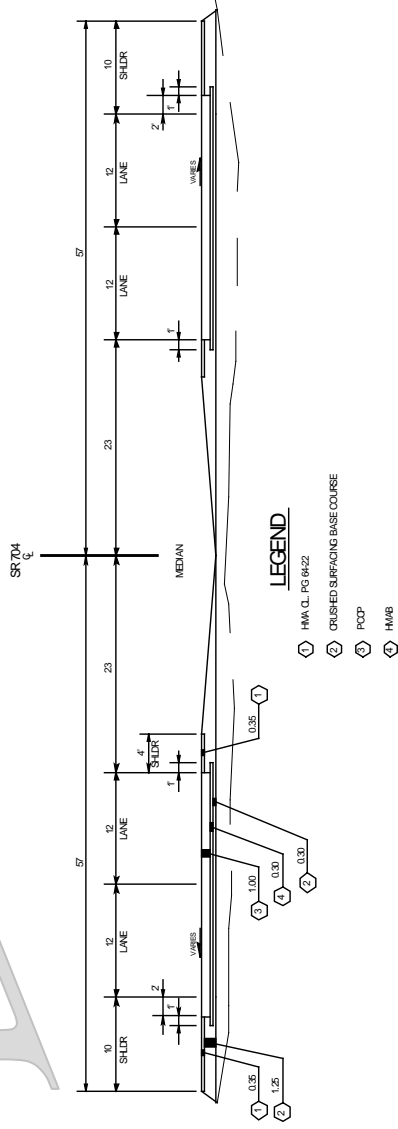

**Figure A4.2**

**5. PCC Rehabilitation**

The 30-year rehabilitation cycles were selected by conducting a historical analysis from state routes in the vicinity with similar AADT's and truck percentages (see Appendix 4-B, Table A4-B.2).

Only one rehabilitation cycle is scheduled for 2038 to diamond grind the wearing surface, clean and reseal all joints and cracks. A summary of the construction and rehabilitation is shown in Table A4.2.

**Table A4.2. PCC Construction and Rehabilitation Summary**

Construction Category	Year	Description
Initial Construction (2008)	0	Construct 2 (12 ft.) lanes each direction  <b>Mainline</b> 1.00-ft. PCC 0.30-ft. HMA base 0.30-ft. CSBC  <b>Shoulders</b> 0.35-ft. HMA Class ½” 1.25-ft. CSBC
Rehabilitation #1 (2038)	30	PCC grinding, cleaning, reseal joints and cracks

## II. Life Cycle Cost Analysis (LCCA)

### 1. The LCCA is based on the following parameters:

- **Roadway Section:** A one-mile section of roadway located between MP 3 and 4 was chosen to represent a typical section.
- **Economic Variables:** Estimated initial construction costs, future rehabilitation costs and user costs for this analysis are in 2005 dollars using a 4% discount rate.
- **Traffic Data:** The initial traffic volume of 15,000 ADT and annual growth factor of 1.92% were provided from a consulting firm contracted by the Olympia Design Office.  
Initial construction will not have traffic; therefore, no user cost will be assessed.
- **Truck Percentage**
  - Single Unit Trucks (4.0%)
  - Combination Trucks (6.0%)
- **Free Flow Capacity:** The LCCA software calculated a Free Flow Capacity of 2137 based on the Transportation Research Board’s “1994 Highway Capacity Manual”.
- **Traffic Speed during Work Zone Conditions:** A 40 mph reduced speed limit was used during the work zone lane closure periods.
- **Functional Classification:** This highway was assigned a “Rural” functional classification due to its location and population density.
- **Queue Dissipation Capacity:** Queue Dissipation Capacity of 1,818 passenger cars/lane/hour was used for all rehabilitation cycles on both alternatives.
- **Maximum ADT (Both Directions):** The ADT for this analysis was capped at 140,000.
- **Maximum Queue Length (Miles):** On this project, a maximum queue length of 2.0 miles was assumed.
- **Work Zone Capacity:** The work zone capacity of 1,340 vehicles per hour per lane (vphpl) was used during lane closure periods.
- **Day-time/Night-time Lane Closures:** This hourly input is based on a 24-hour clock and marks the beginning and ending hours when a lane reduction will be in place during construction activities:
  - Day-time
    - **Inbound:** 9:00 a.m. start time of lane closure and 5:00 p.m. for the reopening time.
    - **Outbound:** 6:00 a.m. start time of lane closure and 3:00 p.m. for the reopening time.

WSDOT Pavement Policy

- o Night-time
  - **Inbound:** 7:00 p.m. start time of lane closure and 5:00 a.m. for the reopening time.
  - **Outbound:** 7:00 p.m. start time of lane closure and 5:00 a.m. for the reopening time.

2. **Estimates**

The initial construction and future rehabilitation estimated costs were based on past WSDOT project bidding and do not represent the actual estimated cost to complete the project. Only items directly related to pavement construction are included (see Appendix 4-C).

3. **LCCA Analysis Software**

Real Cost Version 2.2.0 software was used to perform the analysis (see Appendix 4-D).

4. **Results of LCCA**

The Probabilistic Daytime and Nighttime results are shown in Tables A4.3 and A4.4 and the Deterministic in Tables A4.5 and A4.6 Table A4.7 is a summary for a side-by-side comparison of the results and percent difference. The costs shown here represent the analyzed one-mile section and not the entire 6 mile project length.

**Table A4.3. Probabilistic Results for Day Work Rehabilitation**

Total Cost (present value)	Alternative 1: HMA			Alternative 2: PCC		
	Agency Cost (\$1000)	User Cost (\$1000)	Sum	Agency Cost (\$1000)	User Cost (\$1000)	Sum
Mean	\$2,353.55	\$171.50	\$2,525.05	\$3,600.84	\$193.05	\$3,793.89
Standard Deviation	\$190.06	\$111.66	\$301.72	\$332.74	\$131.70	\$464.44
Minimum	\$1,821.65	\$9.16	\$1,830.81	\$2,589.55	\$5.81	\$2,595.36
Maximum	\$3,033.05	\$545.74	\$3,578.79	\$4,660.71	\$107.78	\$5,268.49

**Table A4.4. Probabilistic Results for Night Work Rehabilitation**

Total Cost (present value)	Alternative 1: HMA			Alternative 2: PCC		
	Agency Cost (\$1000)	User Cost (\$1000)	Sum	Agency Cost (\$1000)	User Cost (\$1000)	Sum
Mean	\$2,353.55	\$43.89	\$2,397.44	\$3,100.84	\$107.72	\$3,638.56
Standard Deviation	\$190.06	\$74.93	\$265.04	\$327.4	\$68.49	\$401.23
Minimum	\$1,821.35	\$4.60	\$1,826.25	\$2,189.55	\$2.92	\$2,592.47
Maximum	\$3,073.05	\$16.55	\$3,089.60	\$4,160.71	\$980.70	\$5,641.41

**Table A4.5. Deterministic Results for Day Work Rehabilitation**

Total Cost (present value)	Alternative 1: HMA			Alternative 2: PCC		
	Agency Cost (\$1000)	User Cost (\$1000)	Sum	Agency Cost (\$1000)	User Cost (\$1000)	Sum
Undiscounted Sum	\$2,879.69	\$559.78	\$3,439.47	\$3,833.67	\$544.86	\$4,378.53
Present Value	\$2,350.10	\$171.47	\$2,521.57	\$3,609.56	\$213.65	\$3,823.21
EUAC	\$109.40	\$7.98	\$117.38	\$168.03	\$9.95	\$177.98

**Table A4.6. Deterministic Results for Night Work Rehabilitation**

Total Cost	Alternative 1: HMA			Alternative 2: PCC		
	Agency Cost (\$1000)	User Cost (\$1000)	Sum	Agency Cost (\$1000)	User Cost (\$1000)	Sum
<b>Undiscounted Sum</b>	\$2,879.69	\$51.71	\$2,931.40	\$3,833.67	\$21.30	\$3,854.97
<b>Present Value</b>	\$2,350.10	\$15.58	\$2,365.68	\$3,609.56	\$8.35	\$3,617.91
<b>EUAC</b>	\$109.40	\$0.73	\$110.13	\$168.03	\$0.39	\$168.42

**Table A4.7. Summary of LCCA Results**

Analysis	Timing	HMA Alternative (\$1000)	PCC Alternative (\$1000)	Percent Difference
<b>Probabilistic (mean present value)</b>	<b>Day</b>	\$2,525.05	\$3,793.89	-50%
	<b>Night</b>	\$2,397.44	\$3,638.56	-52%
<b>Deterministic (present value)</b>	<b>Day</b>	\$2,521.57	\$3,823.21	-52%
	<b>Night</b>	\$2,365.68	\$3,617.91	-53%

### III. Project specific externalities

Identification of project specific externalities is not required, since the cost difference between HMA and PCC alternatives is greater than 15%. The HMA alternative is between 50 and 53 % less than the PCCP alternative for all cases. The Olympic Region recommends the use of HMA for constructing SR 704. Use of HMA represents a substantial savings to WSDOT.

## Appendix 4-A – Pavement Design



Washington State  
Department of Transportation

Memorandum

May 12, 2005

TO: Linda Pierce/Jeff Uhlmeyer, 4-7365

FROM: Mel Hitzke, 4-7440 <sup>mmh</sup>

SUBJECT: SR 704 Cross-Base Highway  
XL-2117  
Surfacing Recommendations

This is the Olympic Region Materials surfacing recommendations for the SR 704 Cross-Base Highway located in central Pierce County. This project will create a new six-mile long, East-West connection between I-5 at Thorne Lane and SR 7 at 176<sup>th</sup> Street. The proposed multi-lane highway will consist of (4) 12-ft. lanes, 46-ft. median, 4-ft. inside shoulders and 10-ft. outside shoulders. The project is designed to provide for future HOV lanes in the median.

The estimated 50-year design ESAL's for this project are 77 million. Based on 90% lane distribution, 70 million ESAL's were used in the pavement design program DARWIN for determining the HMA surfacing depth. The attached ESAL calculations are based on traffic data provided by the Olympia Design Office. The PCC surfacing depths were taken from the WSDOT Pavement Guide, Volume 1, September 2004 Edition, Table 16, using design period ESAL's greater than 50 million with 85% reliability.

The roadway generally follows the existing ground contour with shallow cuts and fills with the exception of a 0.75-mile section on fill ranging from 10-30 feet. The soil classification in this area varies from medium dense, well-graded GRAVEL with sand, to medium dense, poorly graded SAND with gravel. Given these soil parameters it is estimated the R-Value for this area will range from 50-60. A subgrade resilient modulus of 15,000 psi was selected for use in the DARWIN layered thickness design program.

We request that Headquarters Materials Lab review and concur with the following recommendations:

This memo addresses surfacing depths for both flexible and rigid pavement types used in the life cycle cost analysis for this project.

Linda Pierce/Jeff Uhlmeier, 4-7365  
SR 704 Cross-Base Highway XL-2117  
May 12, 2005  
Page 2

**RECOMMENDATIONS:**

**Flexible Pavement**

Mainline and Left Shoulder                      Right Shoulder

0.80-ft. HMA ½" (PG 64-22)                      0.25-ft. HMA ½" (PG 64-22)  
0.67-ft. CSBC                                      1.22-ft. CSBC

The inside shoulder is full depth to facilitate the addition of the future HOV without the need to temporarily shift traffic during construction.

**Rigid Pavement**

Mainline    Shoulders

1.00-ft. PCCP                                      0.35-ft. HMA ½" (PG 64-22)  
0.30-ft. HMAB                                      1.25-ft. CSBC  
0.30-ft. CSBC

**Notes:**

0.05-ft. PCCP added for future diamond grind.

HMA shoulder section has been increased from 0.25-ft. to 0.35-ft. to allow for section loss from future diamond grinding of the PCCP. The additional HMA depth will also provide sufficient support when a temporary traffic shift is required for the addition of HOV lanes.

A LCCA utilizing the recommended surfacing depths will be conducted for this project as required by the "Pavement Type Selection Protocol".

  
Jeff Uhlmeier  
Pavement Design Engineer

5-12-05  
Date

MH:tm  
TM

cc: Gordon Roycroft/Mary Lou Nebergall, 4-7445  
OR Program Management, 4-7440



EXPIRES 1-21-06

## Appendix 4-B – Documentation for HMA Performance Life

Table A4-B.1. HMA Rehabilitation Cycle Determination

Section 2003 ADI, Truck %	SR 6 NB				SR 6 SB				SR 167 NB		SR 167 SB		SR 167 SB	
	ADT 68 K, 12.4% Trucks				ADT 68 K, 12.4% Trucks				ADT 47 K, 8.4% Trucks		ADT 47 K, 8.4% Trucks		ADT 47 K, 8.4% Trucks	
	MP	MP	MP	MP	MP	MP	MP	MP	MP	MP	MP	MP	MP	MP
	118.42	120.27	120.27	120.87	118.00	120.00	120	122.88	8.84	MP 7.22	MP 7.62	MP 8.82	MP 8.72	MP 8.88
1954														
1955														
1956														
1957	0.33' Overlay				0.33' Overlay									
1958	13				13									
1959	13				13									
1960	13				13									
1961	13				13									
1962	13				13									
1963	13				13									
1964	13				13									
1965	13				13									
1966	13				13									
1967	13				13									
1968	13				13									
1969	13				13									
1970	0.25' Overlay				0.25' Overlay									
1971	0.25' Overlay				0.25' Overlay									
1972	0.25' Overlay				0.25' Overlay									
1973	10				10									
1974	10				10									
1975	10				10									
1976	10				10									
1977	10				10									
1978	10				10									
1979	10				10									
1980	0.15' Overlay				0.08' Overlay									
1981	15				15									
1982	15				15									
1983	15				15									
1984	15				15									
1985	15				15									
1986	15				15									
1987	15				15									
1988	15				15									
1989	15				15									
1990	15				15									
1991	15				15									
1992	15				15									
1993	15				15									
1994	15				15									
1995	0.15' Inlay				0.15' Overlay									
1996	15				15									
1997	15				15									
1998	15				15									
1999	15				15									
2000	15				15									
2001	15				15									
2002	15				15									
2003	15				15									
2004	0.17' Overlay				0.17' Overlay									
2005	0.20' Overlay				0.20' Overlay									

Legend: HMA Depth (Yellow), Years Between Rehab (Blue), Average 18.8, Std Dev 2.4



Table A4-B.2. PCC Rehabilitation Cycle Determination

Section	SR 5 NB		SR 5 SB		SR 5 NB & SB		SR 5 NB & SB	
2003 ADT, Truck %	ADT 50K, 10.3% Trucks		ADT 50K, 10.3% Trucks		ADT +100K, 8.0% Trucks		ADT +100K, 8.0% Trucks	
Year	MP	MP	MP	MP	MP	MP	MP	MP
	109.17	116.79	109.14	114.51	128.08	130.58	132.88	134.1
1959					New Constr			
1960								
1961								
1962								
1963								
1964								
1965								
1966							New Constr	
1967								
1968								
1969	New Constr		New Constr					
1970								
1971								
1972								
1973								
1974								
1975								
1976								
1977								
1978								
1979					39			
1980								
1981								
1982								
1983	24							
1984			28					
1985								
1986							38	
1987								
1988								
1989								
1990								
1991								
1992								
1993								
1994								
1995								
1996	DBE, Diamond Grind							
1997								
1998			DBE, Diamond Grind					
1999					DBE, Diamond Grind			
2000								
2001								
2002								
2003								
2004								
2005								
Legend	PCCP		Year Between Rehabil					
Average	32.8		Std Dev	6.7				

## Appendix 4-C – Cost Estimates

Table A4-C.1 Construction Items and Unit Prices

### SURFACING

Ton Crushed Surfacing Base Course \$15.00

### CEMENT CONCRETE PAVEMENT

SY Portland Cement Concrete Pavement Grinding \$9.00

L.F. Clean and Seal Random Cracks \$11.00

L.F. Clean and Reseal Concrete Joints \$2.20

CY Cement Concrete Pavement (Excluding Dowel Bars) \$160.00

2% Ride Smoothness Compliance Adjustment 2%

Each Stainless Steel Dowel Bars \$1.00

L.F. Longitudinal Joint Seal \$1.00

### ASPHALT

Ton HMA CL 3/4" PG 64-22 \$45.00

Ton HMA CL 1/2" PG 64-22 \$45.00

Ton Anti Stripping Additive \$1.00

2% Compaction Price Adjustment (HMA CL 1/2" PG 64-22) 2%

2% Compaction Price Adjustment (HMA CL 3/4" PG 64-22) 2%

3% Job Mix Compliance (HMA CL 1/2" PG 64-22) 3%

3% Job Mix Compliance (HMA CL 3/4" PG 64-22) 3%

SY Planning Bituminous Pavement \$2.00

Ton Asphalt For Fog Seal \$265.00

### TRAFFIC

Day Traffic Control Labor (4 people, 10 hrs./day) \$1,400.00

Day Traffic Control Supervisor \$320.00

Day Traffic Control Vehicle \$70.00

### MISCELLANEOUS

LS Mobilization 5%

EST Engineering and Contingencies 15%

EST Preliminary Engineering 10%

EST Sales Tax 8.4%

WSDOT Pavement Policy

**Table A4-C.2 Initial HMA Construction Year 2008**

**Detail: New HMA Construction - Lanes and Left Shoulder (0.80 ft HMA CL 1/2" PG 64-22 and 0.67 ft CSBC), Right Shoulder ( 0.25 ft HMA CL 1/2" PG 64-22 and 1.22 ft CSBC)**

Quantity	Unit	Bid Item	Unit Price	Amount
33,374	Ton	Crushed Surfacing Base Course	\$15.00	\$500,610
18,245	Ton	HMA CL 1/2" PG 64-22	\$45.00	\$821,025
18,245	Ton	Anti Stripping Additive	\$1.00	\$18,245
\$694,440	2%	Compaction Price Adjustment (HMA CL 1/2" PG 64-22, 18,245 Tons-No shoulders)	2%	\$13,889
\$821,025	3%	Job Mix Compliance (HMA CL 1/2" PG 64-22)	3%	\$24,731
			Items Subtotal	\$1,378,500
			Mobilization (5% of Items Subtotal)	\$68,925 Use same value on PCCP Mobilization
			Contract Items Subtotal (Items Incl. Mobilization)	\$1,447,425
			Sales Tax (3.0% of Contract Items Subtotal)	\$43,423 Use same value on PCCP Sales Tax
			Contract Subtotal (Contract Items Incl. Sales Tax)	\$1,568,895
			Engineering and Contingencies (5% of Contract Subtotal)	\$235,334 Use same value on PCCP Engineering and Contingencies
			Total Construction Subtotal (Contract Incl. Engineering and Contingencies)	\$1,804,229
			Preliminary Engineering (10% of Total Construction Subtotal)	\$180,423 Use same value on PCCP Preliminary Engineering
			<b>Total Project Cost (Total Construction Incl. Preliminary Engineering)</b>	<b>\$1,984,652</b>

WSDOT Pavement Policy

**Table A4-C.3 HMA Rehabilitation #1 Year 2021, #3 Year 2047**

**Detail: Overlay Shoulder to Shoulder 0.15 HMA CL 1/2" PG 64-22**

Quantity	Unit	Bid Item	Unit Price	Amount	Quantity Per Day	Days
150	Ton	Crushed Surfacing Base Course	\$15.00	\$2,250		
4,581	Ton	HMA CL 1/2" PG 64-22	\$45.00	\$206,145	2,000	3
4,581	Ton	Anti Stripping Additive	\$1.00	\$4,581		
\$130,185	2%	Compaction Price Adjustment (HMA CL 1/2" PG 64-22, 2,893 Tons-No shoulders)	2%	\$2,604		
\$206,145	3%	Job Mix Compliance (HMA CL 1/2" PG 64-22)	3%	\$6,184		
					<b>Construction Time (Days)</b>	<b>3</b>
3	Day	Traffic Control Labor (4 people, 10 hr/days @\$35/hr)	\$1,400.00	\$4,200		
3	Day	Traffic Control Supervisor	\$320.00	\$960		
3	Day	Traffic Control Vehicle	\$70.00	\$210		
		Items Subtotal		\$227,134		
		Mobilization (5% of Items Subtotal)		\$11,357		
		Contract Items Subtotal (Items Incl. Mobilization)		\$238,491		
		Sales Tax (8.4% of Contract Items Subtotal)		\$20,033		
		Contract Subtotal (Contract Items Incl. Sales Tax)		\$258,524		
		Engineering and Contingencies (15% of Contract Subtotal)		\$38,779		
		Total Construction Subtotal (Contract Incl. Engineering and Contingencies)		\$297,303		
		Preliminary Engineering (10% of Total Construction Subtotal)		\$29,730		
<b>Total Project Cost (Total Construction Incl. Preliminary Engineering)</b>				<b>\$327,033</b>		

WSDOT Pavement Policy

**Table A4-C.4 HMA Rehabilitation #2 Year 2034**

**Detail: Grind and Inlay Fog Line to Fog Line 0.15 HMA CL 1/2" PG 64-22**

Quantity	Unit	Bid Item	Unit Price	Amount	Quantity Per Day	Days
2,893	Ton	HMA CL 1/2" PG 64-22	\$45.00	\$130,185	1,500	2
2,893	Ton	Anti Stripping Additive	\$1.00	\$2,893		
\$130,185	2%	Compaction Price Adjustment (HMA CL 1/2" PG 64-22)	2%	\$2,604		
\$130,185	3%	Job Mix Compliance (HMA CL 1/2" PG 64-22)	3%	\$3,906		
28,160	SY	Planning Bituminous Pavement	\$2.00	\$56,320		1
3.0	Ton	Asphalt For Fog Seal (Shoulders)	\$265.00	\$795		
				<b>Construction Time</b>	<b>(Days)</b>	<b>3</b>
3	Day	Traffic Control Labor (4 people, 10 hr days)	\$1,400.00	\$4,200		
3	Day	Traffic Control Supervisor	\$320.00	\$960		
3	Day	Traffic Control Vehicle	\$70.00	\$210		
				Items Subtotal	\$202,073	
				Mobilization (5% of Items Subtotal)	\$10,104	
				Contract Items Subtotal (Items Incl. Mobilization)	\$212,177	
				Sales Tax (8.4% of Contract Items Subtotal)	\$17,823	
				Contract Subtotal (Contract Items Incl. Sales Tax)	\$230,000	
				Engineering and Contingencies (15% of Contract Subtotal)	\$34,500	
				Total Construction Subtotal (Contract Incl. Engineering and Contingencies)	\$264,500	
				Preliminary Engineering (10% of Total Construction Subtotal)	\$26,450	
				<b>Total Project Cost ( Total Construction Incl. Preliminary Engineering)</b>	<b>\$290,950</b>	

WSDOT Pavement Policy

**Table A4-C.5 Initial PCCP Construction Year 2008**

**Detail: PCCP New Construction 1.00 ft PCCP with Stainless Steel Dowel Bars on 0.30' HMA CL 3/4" PG 64-22 Base, 0.30' CSBC, Shoulder 0.35' HMA CL 1/2" PG 64-22 w/ 1.25' CSBC**

<b>Quantity</b>	<b>Unit</b>	<b>Bid Item</b>	<b>Unit Price</b>	<b>Amount</b>
10,169	CY	Cement Concrete Pavement (Excluding Dowel Bars)	\$160.00	\$1,627,040
14,120	EA	Stainless Steel Dowel Bars	\$15.00	\$211,800
50,036	L.F.	Longitudinal Joint Seal	\$2.00	\$100,072
\$1,627,040				
0	CALC	Ride Smoothness Compliance Adjustment	2%	\$32,541
27,176	Ton	Crushed Surfacing Base Course	\$15.00	\$407,640
6,751	Ton	HMA CL 3/4" PG 64-22	\$45.00	\$303,795
3,376	Ton	HMA CL 1/2" PG 64-22	\$45.00	\$151,920
10,127	Ton	Anti Stripping Additive	\$1.00	\$10,127
\$455,715	3%	Job Mix Compliance (HMA CL 3/4" PG 64-22 & HMA CL 1/2" PG 64-22)	3%	\$13,671
		Items Subtotal		\$2,858,606
		Use HMA's Initial Construction Mobilization		\$68,920
		Contract Items Subtotal (Items Incl. Mobilization)		\$2,927,526
		Use HMA's Initial Construction Sale Tax		\$121,575
		Contract Subtotal (Contract Items Incl. Sales Tax)		\$3,049,101
		Use HMA's Initial Construction Engineering and Contingencies		\$235,334
		Total Construction Subtotal (Contract Incl. Engineering and Contingencies)		\$3,284,435
		Use HMA's Initial Construction Preliminary Engineering		\$180,423
		<b>Total Project Cost ( Total Construction Incl. Preliminary Engineering)</b>		<b>\$3,464,858</b>

WSDOT Pavement Policy

**Table A4-C.6 PCCP Rehabilitation #1 Year 2038**

Detail: **Grind PCCP and Clean and Reseal Joints**

Quantity	Unit	Bid Item	Unit Price	Amount	Quantity Per Day	Days
28160	SY	Portland Cement Concrete Pavement Grinding	\$9.00	\$253,440	5,000	6
48624	L.F.	Saw Clean and Seal Concrete Joints	\$2.20	\$106,973	17,000	3
140	L.F.	Clean and Seal Random Cracks	\$11.00	\$1,540		
3.0	Ton	Asphalt For Fog Seal (Shoulders)	\$265.00	\$795		
253440	Calc	Ride Smoothness Compliance Adjustment	2%	\$5,069		
		<b>Construction Time (Days)</b>				<b>9</b>
9	Day	Traffic Control Labor (4 people, 10 hr days)	\$1,400.00	\$12,600		
9	Day	Traffic Control Supervisor	\$320.00	\$2,880		
9	Day	Traffic Control Vehicle	\$70.00	\$630		
		Item Subtotal		\$383,927		
		Mobilization (5% of Item Subtotal)		\$19,196		
		Contract Items Subtotal (Contract Incl. Mobilization)		\$403,123		
		Sales Tax (8% of Contract Items Subtotal)		\$33,862		
		Contract Subtotal (Contract Items Incl. Sales Tax)		\$436,985		
		Engineering and Contingencies (15% of Contract Subtotal)		\$65,548		
		Total Construction Subtotal (Contract Incl. Engineering and Contingencies)		\$502,533		
		Preliminary Engineering (10% of Total Construction Subtotal)		\$50,253		
<b>Total Project Cost ( Total Construction Incl. Preliminary Engineering)</b>				<b>\$552,786</b>		

## Appendix 4-D – LCCA Worksheets

**Table A4-D.1 Economic Variables, Analysis Options, Project Details and Traffic**

<b>1. Economic Variables</b>	
Value of Time for Passenger Cars (\$/hour)	LCCATRIANG(12,13.96,16)
Value of Time for Single Unit Trucks (\$/hour)	LCCATRIANG(20,22.34,24)
Value of Time for Combination Trucks (\$/hour)	LCCATRIANG(25,26.89,29)
<b>2. Analysis Options</b>	
Include User Costs in Analysis	
Include User Cost Remaining Service Life Value	
Use Differential User Costs	
User Cost Computation Method	
Include Agency Cost Remaining Service Life Value	
Traffic Direction	
Analysis Period (Years)	
Beginning of Analysis Period	
Discount Rate (%)	LCCATRIANG(3,4,5)
<b>3. Project Details and Quantity Calculations</b>	
State Route	
Project Name	
Region	
County	
Analyzed By	
Mileposts	
Begin	
End	
Length of Project (miles)	6.00
Comments	This project will create a new multi-lane East-West Highway, 6 miles long between I-5 at Thorne Lane and SR 7 at 176th Street.
<b>4. Traffic Data</b>	
AADT Construction Year (total for both directions)	30,866
Cars as Percentage of AADT (%)	90.0
Single Unit Trucks as Percentage of AADT (%)	
Combination Trucks as Percentage of AADT (%)	
Annual Growth Rate of Traffic (%)	
	LCCANORMAL(1.92,1)
Speed Limit Under Normal Operating Conditions (mph)	
No of Lanes in Each Direction During Normal Conditions	
Free Flow Capacity (vphpl)	
Rural or Urban Hourly Traffic Distribution	
Queue Dissipation Capacity (vphpl)	
	LCCANORMAL(1818,144)
Maximum AADT (total for both directions)	
Maximum Queue Length (miles)	



**Table A4-D.2 Daytime HMA Alternative 1 Input Data**

<b>Initial Construction</b>		<b>Year 2008, Initial Construction</b>	
Agency Construction Cost (\$1000)		\$1,985.00	
		<b>LCCANORMAL(1985,198.5)</b>	
User Work Zone Costs (\$1000)			
Work Zone Duration (days)		0	
No of Lanes Open in Each Direction During Work		2	
Activity Service Life (years)		13.0	
		<b>LCCATRIANG(11,13,15)</b>	
Maintenance Frequency (years)			
Agency Maintenance Cost (\$1000)			
Work Zone Length (miles)		1.00	
Work Zone Speed Limit (mph)		40	
Work Zone Capacity (vphpl)		1340	
Time of Day of Lane Closures (use whole numbers based on a 24-hour clock)			
Inbound		Start	End
First period of lane closure			
Second period of lane closure			
Third period of lane closure			
Outbound		Start	End
First period of lane closure			
Second period of lane closure			
Third period of lane closure			
<b>Rehabilitation #1</b>		<b>Year 2021, Rehab # 1 - 0.15' HMA Overlay</b>	
Agency Construction Cost (\$1000)		\$327.00	
		<b>LCCANORMAL(327,32.7)</b>	
User Work Zone Costs (\$1000)			
Work Zone Duration (days)		3	
No of Lanes Open in Each Direction During Work		1	
Activity Service Life (years)		13.0	
		<b>LCCATRIANG(11,13,15)</b>	
Maintenance Frequency (years)			
Agency Maintenance Cost (\$1000)			
Work Zone Length (miles)		1.00	
Work Zone Speed Limit (mph)		40	
Work Zone Capacity (vphpl)		1340	
Time of Day of Lane Closures (use whole numbers based on a 24-hour clock)			
Inbound		Start	End
First period of lane closure		9	17
Second period of lane closure			
Third period of lane closure			
Outbound		Start	End
First period of lane closure		6	15
Second period of lane closure			
Third period of lane closure			

**Table A4-D.2 Daytime HMA Alternative 1 Input Data (cont.)**

<b>Rehabilitation #2</b>	Year 2034, Rehab # 2 - 0.15' HMA Inlay	
Agency Construction Cost (\$1000)	\$291.00	
	<b>LCCANORMAL(291,29.1)</b>	
User Work Zone Costs (\$1000)		
Work Zone Duration (days)	3	
No of Lanes Open in Each Direction During Work	1	
Activity Service Life (years)	13.0	
	<b>LCCATRIANG(11,13,15)</b>	
Maintenance Frequency (years)		
Agency Maintenance Cost (\$1000)		
Work Zone Length (miles)	1.00	
Work Zone Speed Limit (mph)	40	
Work Zone Capacity (vphpl)	1340	
Time of Day of Lane Closures (use whole numbers based on a 24-hour clock)		
Inbound	Start	End
First period of lane closure	9	17
Second period of lane closure		
Third period of lane closure		
Outbound	Start	End
First period of lane closure	6	15
Second period of lane closure		
Third period of lane closure		
<b>Rehabilitation #3</b>	Year 2047, Rehab # 3 - 0.15' HMA Overlay	
Agency Construction Cost (\$1000)	\$327.00	
	<b>LCCANORMAL(327,32.7)</b>	
User Work Zone Costs (\$1000)		
Work Zone Duration (days)	3	
No of Lanes Open in Each Direction During Work	1	
Activity Service Life (years)	13.0	
	<b>LCCATRIANG(11,13,15)</b>	
Maintenance Frequency (years)		
Agency Maintenance Cost (\$1000)		
Work Zone Length (miles)	1.00	
Work Zone Speed Limit (mph)	40	
Work Zone Capacity (vphpl)	1340	
Time of Day of Lane Closures (use whole numbers based on a 24-hour clock)		
Inbound	Start	End
First period of lane closure	9	17
Second period of lane closure		
Third period of lane closure		
Outbound	Start	End
First period of lane closure	6	15
Second period of lane closure		
Third period of lane closure		

**Table A4-D.3 Daytime PCCP Alternative 2 Input Data**

<b>Initial Construction</b>		
Agency Construction Cost (\$1000)		
	<b>LCCANORMAL</b>	<b>(3465,346.5)</b>
User Work Zone Costs (\$1000)		
Work Zone Duration (days)		
No of Lanes Open in Each Direction During Work		
Activity Service Life (years)	30.0	
	<b>LCCATRIANG</b>	<b>(25,30,35)</b>
Maintenance Frequency (years)		
Agency Maintenance Cost (\$1000)		
Work Zone Length (miles)	1.00	
Work Zone Speed Limit (mph)	60	
Work Zone Capacity (vphpl)	1340	
Time of Day of Lane Closures (use whole numbers based on a 24-hour clock)		
Inbound	Start	End
First period of lane closure		
Second period of lane closure		
Third period of lane closure		
Outbound	Start	End
First period of lane closure		
Second period of lane closure		
Third period of lane closure		
<b>Rehabilitation #1</b>		
	Year 2038, Rehab #1 - Diamond Grind, Reseal Joints, Repair Panels	
Agency Construction Cost (\$1000)	\$553.00	
	<b>LCCANORMAL</b>	<b>(553,55.3)</b>
User Work Zone Costs (\$1000)		
Work Zone Duration (days)	9	
No of Lanes Open in Each Direction During Work	1	
Activity Service Life (years)	30.0	
	<b>LCCATRIANG</b>	<b>(25,30,35)</b>
Maintenance Frequency (years)		
Agency Maintenance Cost (\$1000)		
Work Zone Length (miles)		
Work Zone Speed Limit (mph)		
Work Zone Capacity (vphpl)		
Time of Day of Lane Closures (use whole numbers based on a 24-hour clock)		
Inbound	Start	End
First period of lane closure		
Second period of lane closure		
Third period of lane closure		
Outbound	Start	End
First period of lane closure		
Second period of lane closure		
Third period of lane closure		

**Table A4-D.4 Daytime Deterministic Results**

Total Cost	Alternative 1: HMA Roadway (Day Time Construction)		Alternative 2: PCCP Roadway (Day Time Construction)	
	Agency Cost (\$1000)	User Cost (\$1000)	Agency Cost (\$1000)	User Cost (\$1000)
Undiscounted Sum	\$2,879.69	\$559.78	\$3,833.67	\$544.86
Present Value	\$2,350.10	\$171.47	\$3,609.56	\$213.65
EUAC	\$109.40	\$7.98	\$168.03	\$9.95

**Table A4-D.5 Daytime Probabilistic Results**

Total Cost (Present Value)	Alternative 1: HMA Roadway (Day Time Construction)		Alternative 2: PCCP Roadway (Day Time Construction)	
	Agency Cost (\$1000)	User Cost (\$1000)	Agency Cost (\$1000)	User Cost (\$1000)
Mean	\$2,353.55	\$171.50	\$3,600.84	\$193.05
Standard Deviation	\$190.06	\$111.66	\$332.74	\$131.70
Minimum	\$1,821.65	\$9.16	\$2,589.55	\$5.81
Maximum	\$3,033.05	\$545.74	\$4,660.71	\$607.78

**Table A4-D.6 Nighttime HMA Alternative 1 Input Data**

<b>Initial Construction</b>	Year 2008, Initial Construction	
Agency Construction Cost (\$1000)	\$1,985.00	
	<b>LCCANORMAL(1985,198.5)</b>	
User Work Zone Costs (\$1000)		
Work Zone Duration (days)	0	
No of Lanes Open in Each Direction During Work Zone	2	
Activity Service Life (years)	13.0	
	<b>LCCATRIANG(11,13,15)</b>	
Maintenance Frequency (years)		
Agency Maintenance Cost (\$1000)		
Work Zone Length (miles)	1.00	
Work Zone Speed Limit (mph)	40	
Work Zone Capacity (vphpl)	1340	
Time of Day of Lane Closures (use whole numbers based on a 24-hour clock)		
Inbound	Start	End
First period of lane closure		
Second period of lane closure		
Third period of lane closure		
Outbound	Start	End
First period of lane closure		
Second period of lane closure		
Third period of lane closure		

**Table A4-D.6 Nighttime HMA Alternative 1 Input Data – continued...**

<b>Rehabilitation #1</b>	Year 2021, Rehab # 1 - 0.15' HMA Overlay	
Agency Construction Cost (\$1000)	\$327.00	
	<b>LCCANORMAL(327,32.7)</b>	
User Work Zone Costs (\$1000)		
Work Zone Duration (days)	3	
No of Lanes Open in Each Direction During Work Zone	1	
Activity Service Life (years)	13.0	
	<b>LCCATRIANG(11,13,15)</b>	
Maintenance Frequency (years)		
Agency Maintenance Cost (\$1000)		
Work Zone Length (miles)	1.00	
Work Zone Speed Limit (mph)	40	
Work Zone Capacity (vphpl)	1340	
Time of Day of Lane Closures (use whole numbers based on a 24-hour clock)		
Inbound	Start	End
First period of lane closure	19	24
Second period of lane closure	0	5
Third period of lane closure		
Outbound	Start	End
First period of lane closure	19	24
Second period of lane closure	0	5
Third period of lane closure		
<b>Rehabilitation #2</b>	Year 2034, Rehab # 2 - 0.15' HMA Inlay	
Agency Construction Cost (\$1000)	\$291.00	
	<b>LCCANORMAL(291,29.1)</b>	
User Work Zone Costs (\$1000)		
Work Zone Duration (days)	3	
No of Lanes Open in Each Direction During Work Zone	1	
Activity Service Life (years)	13.0	
	<b>LCCATRIANG(11,13,15)</b>	
Maintenance Frequency (years)		
Agency Maintenance Cost (\$1000)		
Work Zone Length (miles)	1.00	
Work Zone Speed Limit (mph)	40	
Work Zone Capacity (vphpl)	1340	
Time of Day of Lane Closures (use whole numbers based on a 24-hour clock)		
Inbound	Start	End
First period of lane closure	19	24
Second period of lane closure	0	5
Third period of lane closure		
Outbound	Start	End
First period of lane closure	19	24
Second period of lane closure	0	5
Third period of lane closure		

**Table A4-D.6 Nighttime HMA Alternative 1 Input Data – continued...**

<b>Rehabilitation #3</b>	Year 2047, Rehab # 3 - 0.15' HMA Overlay	
Agency Construction Cost (\$1000)	\$327.00	
	<b>LCCANORMAL(327,32.7)</b>	
User Work Zone Costs (\$1000)		
Work Zone Duration (days)	3	
No of Lanes Open in Each Direction During Work Zone	1	
Activity Service Life (years)	13.0	
	<b>LCCATRIANG(11,13,15)</b>	
Maintenance Frequency (years)		
Agency Maintenance Cost (\$1000)		
Work Zone Length (miles)	1.00	
Work Zone Speed Limit (mph)	40	
Work Zone Capacity (vphpl)	1340	
Time of Day of Lane Closures (use whole numbers based on a 24-hour clock)		
Inbound	Start	End
First period of lane closure	19	24
Second period of lane closure	0	5
Third period of lane closure		
Outbound	Start	End
First period of lane closure	19	24
Second period of lane closure	0	5
Third period of lane closure		

**Table A4-D.7 Nighttime PCCP Alternative 2 Input Data**

<b>Initial Construction</b>	Year 2008, Initial	
Agency Construction Cost (\$1000)	\$3,465.00	
	<b>LCCANORMAL(3465,346.5)</b>	
User Work Zone Costs (\$1000)		
Work Zone Duration (days)	0	
No of Lanes Open in Each Direction During Work Zone	2	
Activity Service Life (years)	30.0	
	<b>LCCATRIANG(25,30,35)</b>	
Maintenance Frequency (years)		
Agency Maintenance Cost (\$1000)		
Work Zone Length (miles)	1.00	
Work Zone Speed Limit (mph)	60	
Work Zone Capacity (vphpl)	1340	
Time of Day of Lane Closures (use whole numbers based on a 24-hour clock)		
Inbound	Start	End
First period of lane closure		
Second period of lane closure		
Third period of lane closure		
Outbound	Start	End
First period of lane closure		
Second period of lane closure		
Third period of lane closure		

**Table A4-D.7 Nighttime PCCP Alternative 2 Input Data – continued...**

WSDOT Pavement Policy

<b>Rehabilitation #1</b>	Year 2043 Rehab #1 - Diamond Grind, Reseal Joints, Repair Panels	
Agency Construction Cost (\$1000)	LCCANORMAL(553,55.3)	
User Work Zone Costs (\$1000)		
Work Zone Duration (days)		
No of Lanes Open in Each Direction During Work Zone		
Activity Service Life (years)	LCCATRIANG(25,30,35)	
Maintenance Frequency (years)		
Agency Maintenance Cost (\$1000)		
Work Zone Length (miles)	1.00	
Work Zone Speed Limit (mph)	40	
Work Zone Capacity (vphpl)	1340	
Time of Day of Lane Closures (use whole numbers based on a 24-hour clock)		
Inbound	Start	End
First period of lane closure	19	24
Second period of lane closure	0	5
Third period of lane closure		
Outbound	Start	End
First period of lane closure	19	24
Second period of lane closure	0	5
Third period of lane closure		

**Table A4-D.8 Nighttime Deterministic Results**

Total Cost	Alternative 1: HMA Roadway (Night Time Construction)		Alternative 2: PCCP Roadway (Night Time Construction)	
	Agency Cost (\$1000)	User Cost (\$1000)	Agency Cost (\$1000)	User Cost (\$1000)
Undiscounted Sum	\$2,879.69	\$51.71	\$3,833.67	\$21.30
Present Value	\$2,350.10	\$15.58	\$3,609.56	\$8.35
EUAC	\$109.40	\$0.73	\$168.03	\$0.39

**Table A4-D.9 Nighttime Probabilistic Results**

Total Cost (Present Value)	Alternative 1: HMA Roadway (Night Time Construction)		Alternative 2: PCCP Roadway (Night Time Construction)	
	Agency Cost (\$1000)	User Cost (\$1000)	Agency Cost (\$1000)	User Cost (\$1000)
Mean	\$2,353.55	\$43.89	\$3,600.84	\$37.72
Standard Deviation	\$190.06	\$74.98	\$332.74	\$68.49
Minimum	\$1,821.65	\$4.60	\$2,589.55	\$2.92
Maximum	\$3,033.05	\$656.55	\$4,660.71	\$980.70





## APPENDIX 5 – WSDOT PROBABILISTIC INPUTS

**Table A5.1 Input Probability Distributions Examples (FHWA, 1998).**

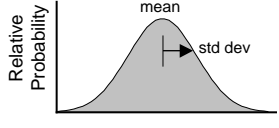
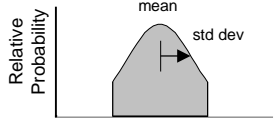
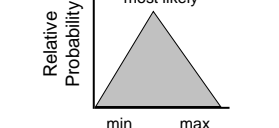
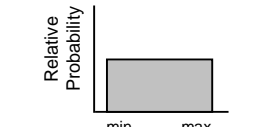
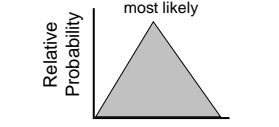
Distribution Type	Spreadsheet Formula	Illustration
Normal	lccanormal (mean, std dev)	
Truncated Normal	lccatnormal (mean, std dev, lower bound, upper bound)	
Triangular	lccatriang (minimum, most likely, maximum)	
Uniform	lccauniform (minimum, most likely, maximum)	
Triangular	lccatriang (minimum, most likely, maximum)	

**Table A5.2 Project Details**

Input	Unit
State Route	
Project Name	
Region	
County	
Analyzed By	
Begin MP	
End MP	
Lane Width	feet
Shoulder Width (left/right and inbound/outbound)	feet

**Table A5.3 Analysis Options**

Input	Unit	Probability Distribution	Value
Analysis Period	year	N/A	50
Discount Rate	%	Triangular	3, 4, 5
Beginning of Analysis Period		N/A	Year of Initial Construction
Include Agency Cost Residual Value		N/A	Yes
Include User Costs in Analysis		N/A	Yes
User Cost Comparison Method		N/A	Calculated
Traffic Direction		N/A	Both, Inbound or outbound
Include User Cost Residual Value		N/A	Yes

**Table A5.4 Traffic Data**

Input	Unit	Probability Distribution	Value
AADT (Both Directions) – Construction Year		N/A	Note 1
Single Unit Trucks as Percentage of AADT	%	N/A	Note 1
Combo Unit Trucks as Percentage of AADT	%	N/A	Note 1
Annual Growth Rate of Traffic	%	Normal	Note 1, 1.0
Speed Limit Under Normal Conditions	mph	N/A	Note 1
Lanes Open in Each Direction Under Normal Operation		N/A	Note 1
Free Flow Capacity	vphpl	Deterministic	Software provides calculator
Queue Dissipation Capacity	vphpl	Normal	1818, 144 (Note 2)
Maximum AADT Both Directions		N/A	Note 3
Maximum Queue Length	mile	N/A	Note 4
Rural/Urban		N/A	Note 1

Note 1 – Growth rate can be obtained from the WSPMS or through Regional information.

Note 2– observed flow rates (FHWA, 1998)

Note 3 – information contained in the Highway Capacity Manual

Note 4 – based on local experience

**Table A5.5 Value of User Time**

Input	Unit	Probability Distribution	Value
Value of Time for Passenger Cars	\$	Triangular	12.00, 13.96, 16.00
Value of Time for Single Unit Trucks	\$	Triangular	20.00, 22.34, 24.00
Value of Time for Combination Trucks	\$	Triangular	25.00, 26.89, 29.00

**Table A5.6 Traffic Hourly Distribution**

Use default values contained in software program unless Region (or project) specific information is available.

**Table A5.7 Added Vehicle Time and Cost**

Use default values contained in the software program, unless Region (or project) specific information is available.

**Table A5.8 Alternatives (initial and future rehabilitation)**

Input	Unit	Probability Distribution	Value
Alternative Description		N/A	
Activity Description		N/A	
Agency Construction Cost	\$1000	Normal	Cost, 10%
Activity Service Life	year	Triangular	Note 1
Maintenance Frequency	year	Triangular	Note 2
Maintenance Cost	\$1000	Normal	Cost, 10%
Work Zone Length	mile	N/A	Value
Work Zone Capacity	vphpl	Deterministic	See Table A5.9
Work Zone Duration	days	Deterministic	Value
Work Zone Speed Limit	mph	N/A	Value
Number of Lanes Open in Each Direction During Work Zone		N/A	Value
Work Zone Hours		N/A	Value

*Note 1: the minimum, most likely, and maximum expected life should be based on regional experience, data contained in the Washington State, and approved by the State Materials Laboratory Pavements Division*

*Note 2: the minimum, most likely, and maximum expected life (if available) should be based on regional experience and approved by the State Materials Laboratory Pavement Division*

**Table A5.9 Measured Average Work Zone Capacities (FHWA, 1998).**

Directional Lanes		Average Capacity	
Normal Operations	Work Zone Operations	Vehicles per Hour	Vehicles per Lane per Hour
3	1	1,170	1,170
2	1	1,340	1,340
5	2	2,740	1,370
4	2	2,960	1,480
3	2	2,980	1,490
4	3	4,560	1,520



## APPENDIX 6 – PROBABILISTIC ANALYSIS EXAMPLE

This example is hypothetical. This project involves the removal and replacement of an existing interstate concrete pavement. Roadway configuration is 4 lanes in each direction with 10-foot right shoulders and 4-foot left shoulders. The alternatives evaluated will include:

1. Removal of the existing PCC and replacement with HMA
  - a. Initial construction
    - 1.0 ft HMA
    - 0.55 ft CSBC
    - 1.55 ft total depth
  - b. Initial construction thickness design based on 50-year performance with future overlays, 10 year cycle with minimum life of 6 years and maximum of 12 years
  - c. Future Overlays
    - i. 0.15 foot overlay in 1<sup>st</sup>, 3<sup>rd</sup>, and 5<sup>th</sup> cycles
    - ii. 45 mm Mill and Fill in 2<sup>nd</sup>, 3<sup>rd</sup>, and 5<sup>th</sup> cycles
2. Removal of the existing PCC and replacement with PCC
  - a. Initial construction
    - 1.0 ft HMA
    - 0.55 ft CSBC
    - 1.55 ft total depth
  - b. Initial construction thickness design based on 50-year performance with future rehabilitation in 25<sup>th</sup> year
  - c. Future Rehabilitation
    - i. Diamond grinding to remove studded tire wear and reseal joints every 25 years (minimum of 20 years and maximum of 30 years)
    - ii. 0.15 ft Mill and Fill in 2<sup>nd</sup>, 3<sup>rd</sup>, and 5<sup>th</sup> cycles (pavement life – minimum of 6 years, most likely 10 years, and maximum 12 years)

## WSDOT Pavement Policy

### LCCA Input Data

<b>1. Economic Variables</b>	
Value of Time for Passenger Cars (\$)	\$11.50
	<b>LCCATRIANG(10,11.5,13)</b>
Value of Time for Single Unit Trucks (\$)	\$18.50
	<b>LCCATRIANG(17,18.5,20)</b>
Value of Time for Combination Trucks (\$)	\$22.50
	<b>LCCATRIANG(21,22.5,24)</b>
<b>2. Analysis Options</b>	
Include User Costs in Analysis	Yes
Include User Cost Residual Value	Yes
Use Differential User Costs	Yes
User Cost Computation Method	Calculated
Include Agency Cost Residual Value	Yes
Traffic Direction	Inbound
Analysis Period (Years)	60
Beginning of Analysis Period	2003
Discount Rate (%)	4.0
	<b>LCCATRIANG(3,4,5)</b>
<b>3. Project Details and Quantity Calculations</b>	
State Route	LCCA Example
Project Name	
Region	
County	
Analyzed By	L. M. Pierce
Beginning MP	0.00
Ending MP	5.00
Length of Project (miles)	5.00
Lane Width (ft)	12.00
	Right
Shoulder Width - Inbound (ft)	10.00
Shoulder Width - Outbound (ft)	10.00
Roadway Area (Square Feet)	1,584,000
Shoulder Area (Square Feet)	369,600
Total Area (Square Feet)	1,953,600
<b>4. Traffic Data</b>	
AADT (Both Directions) - Construction Year	200,000
Cars as Percentage of AADT (%)	90.0
Single Unit Trucks as Percentage of AADT (%)	3.0
Combination Trucks as Percentage of AADT (%)	7.0
Annual Growth Rate of Traffic (%)	2.5
	<b>LCCANORMAL(2,5,2)</b>
Speed Limit Under Normal Condition (mph)	65
No of Lanes in Each Direction During Normal Operation	5
Free Flow Capacity (vphpl)	2074
Rural/Urban	Urban
Queue Dissipation Capacity (vphpl)	1818
	<b>LCCANORMAL(1818,144)</b>
Maximum AADT (Both Directions)	400,000
Maximum Queue Length (miles)	10.0

WSDOT Pavement Policy

**Alternative 1**

<b>Initial Construction</b>	Remove and Replace Existing PCCP with HMA	
Agency Construction Cost (\$1000)	\$12,686.00	
	<b>LCCANORMAL(12686,1268.6)</b>	
User Work Zone Costs (\$1000)	\$200.00	
Work Zone Duration (days)	165	
No of Lanes Open in Each Direction During Work Zone	3	
Activity Service Life (years)	9.3	
	<b>LCCATRIANG(6,10,12)</b>	
Maintenance Frequency (years)	0	
Agency Maintenance Cost (\$1000)	0	
Work Zone Length (miles)	5.00	
Work Zone Speed Limit (mph)	35	
Work Zone Capacity (vphpl)	1500	
Time of Day of Lane Closures (use whole numbers based on a 24-hour clock)		
Inbound	Start	End
First period of lane closure	0	24
Second period of lane closure	0	0
Third period of lane closure	0	0
Outbound	Start	End
First period of lane closure	0	0
Second period of lane closure	0	0
Third period of lane closure	0	0

<b>Rehabilitation #1</b>	Mill and Fill with 2 inch HMA	
Agency Construction Cost (\$1000)	\$2,777.00	
	<b>LCCANORMAL(2777,277.7)</b>	
User Work Zone Costs (\$1000)	\$20.00	
Work Zone Duration (days)	25	
No of Lanes Open in Each Direction During Work Zone	4	
Activity Service Life (years)	9.3	
	<b>LCCATRIANG(6,10,12)</b>	
Maintenance Frequency (years)	0	
Agency Maintenance Cost (\$1000)	0	
Work Zone Length (miles)	1.00	
Work Zone Speed Limit (mph)	35	
Work Zone Capacity (vphpl)	1500	
Time of Day of Lane Closures (use whole numbers based on a 24-hour clock)		
Inbound	Start	End
First period of lane closure	0	5
Second period of lane closure	21	24
Third period of lane closure	0	0
Outbound	Start	End
First period of lane closure	0	0
Second period of lane closure	0	0
Third period of lane closure	0	0

WSDOT Pavement Policy

<b>Rehabilitation #2</b>		2 inch HMA Overlay	
Agency Construction Cost (\$1000)	\$3,409.00		
	<b>LCCANORMAL(3409,340.9)</b>		
User Work Zone Costs (\$1000)	\$30.00		
Work Zone Duration (days)	35		
No of Lanes Open in Each Direction During Work Zone	4		
Activity Service Life (years)	9.3		
	<b>LCCATRIANG(6,10,12)</b>		
Maintenance Frequency (years)	0		
Agency Maintenance Cost (\$1000)	0		
Work Zone Length (miles)	1.00		
Work Zone Speed Limit (mph)	35		
Work Zone Capacity (vphpl)	1500		
Time of Day of Lane Closures (use whole numbers based on a 24-hour clock)			
Inbound	Start	End	
First period of lane closure	0	5	
Second period of lane closure	21	24	
Third period of lane closure	0	0	
Outbound	Start	End	
First period of lane closure	0	0	
Second period of lane closure	0	0	
Third period of lane closure	0	0	

<b>Rehabilitation #3</b>		Mill and Fill with 2 inch HMA	
Agency Construction Cost (\$1000)	\$2,777.00		
	<b>LCCANORMAL(2777,277.7)</b>		
User Work Zone Costs (\$1000)	\$20.00		
Work Zone Duration (days)	25		
No of Lanes Open in Each Direction During Work Zone	4		
Activity Service Life (years)	9.3		
	<b>LCCATRIANG(6,10,12)</b>		
Maintenance Frequency (years)	0		
Agency Maintenance Cost (\$1000)	0		
Work Zone Length (miles)	1.00		
Work Zone Speed Limit (mph)	35		
Work Zone Capacity (vphpl)	1500		
Time of Day of Lane Closures (use whole numbers based on a 24-hour clock)			
Inbound	Start	End	
First period of lane closure	0	5	
Second period of lane closure	21	24	
Third period of lane closure	0	0	
Outbound	Start	End	
First period of lane closure	0	0	
Second period of lane closure	0	0	
Third period of lane closure	0	0	



WSDOT Pavement Policy

<b>Rehabilitation #4</b>		2 inch HMA Overlay	
Agency Construction Cost (\$1000)	\$3,409.00		
	<b>LCCANORMAL(3409,340.9)</b>		
User Work Zone Costs (\$1000)	\$30.00		
Work Zone Duration (days)	35		
No of Lanes Open in Each Direction During Work Zone	4		
Activity Service Life (years)	9.3		
	<b>LCCATRIANG(6,10,12)</b>		
Maintenance Frequency (years)	0		
Agency Maintenance Cost (\$1000)	0		
Work Zone Length (miles)	1.00		
Work Zone Speed Limit (mph)	35		
Work Zone Capacity (vphpl)	1500		
Time of Day of Lane Closures (use whole numbers based on a 24-hour clock)			
Inbound	Start	End	
First period of lane closure	0	5	
Second period of lane closure	21	24	
Third period of lane closure	0	0	
Outbound	Start	End	
First period of lane closure	0	0	
Second period of lane closure	0	0	
Third period of lane closure	0	0	

<b>Rehabilitation #5</b>		Mill and Fill with 2 inch HMA	
Agency Construction Cost (\$1000)	\$2,777.00		
	<b>LCCANORMAL(2777,277.7)</b>		
User Work Zone Costs (\$1000)	\$20.00		
Work Zone Duration (days)	25		
No of Lanes Open in Each Direction During Work Zone	4		
Activity Service Life (years)	9.3		
	<b>LCCATRIANG(6,10,12)</b>		
Maintenance Frequency (years)	0		
Agency Maintenance Cost (\$1000)	0		
Work Zone Length (miles)	1.00		
Work Zone Speed Limit (mph)	35		
Work Zone Capacity (vphpl)	1500		
Time of Day of Lane Closures (use whole numbers based on a 24-hour clock)			
Inbound	Start	End	
First period of lane closure	0	5	
Second period of lane closure	21	24	
Third period of lane closure	0	0	
Outbound	Start	End	
First period of lane closure	0	0	
Second period of lane closure	0	0	
Third period of lane closure	0	0	

WSDOT Pavement Policy

<b>Rehabilitation #6</b>	2 inch HMA Overlay	
Agency Construction Cost (\$1000)	\$3,409.00	
	<b>LCCANORMAL(3409,340.9)</b>	
User Work Zone Costs (\$1000)	\$30.00	
Work Zone Duration (days)	35	
No of Lanes Open in Each Direction During Work Zone	4	
Activity Service Life (years)	9.3	
	<b>LCCATRIANG(6,10,12)</b>	
Maintenance Frequency (years)	0	
Agency Maintenance Cost (\$1000)	0	
Work Zone Length (miles)	1.00	
Work Zone Speed Limit (mph)	35	
Work Zone Capacity (vphpl)	1500	
Time of Day of Lane Closures (use whole numbers based on a 24-hour clock)		
Inbound	Start	End
First period of lane closure	0	5
Second period of lane closure	21	24
Third period of lane closure	0	0
Outbound	Start	End
First period of lane closure	0	0
Second period of lane closure	0	0
Third period of lane closure	0	0

WSDOT Pavement Policy

**Alternative 2**

<b>Initial Construction</b>	Remove and Replace Existing PCC with PCC	
Agency Construction Cost (\$1000)	\$18,249.00	
User Work Zone Costs (\$1000)	\$300.00	
Work Zone Duration (days)	165	
No of Lanes Open in Each Direction During Work Zone	3	
Activity Service Life (years)	35.0	
	<b>LCCATRIANG(25,35,45)</b>	
Maintenance Frequency (years)	0	
Agency Maintenance Cost (\$1000)	0	
Work Zone Length (miles)	5.00	
Work Zone Speed Limit (mph)	35	
Work Zone Capacity (vphpl)	1500	
Time of Day of Lane Closures (use whole numbers based on a 24-hour clock)		
Inbound	Start	End
First period of lane closure	0	24
Second period of lane closure	0	0
Third period of lane closure	0	0
Outbound	Start	End
First period of lane closure	0	0
Second period of lane closure	0	0
Third period of lane closure	0	0

<b>Rehabilitation #1</b>	Diamond Grinding and Joint Resealing	
Agency Construction Cost (\$1000)	\$2,441.00	
	<b>LCCANORMAL(2441,244.1)</b>	
User Work Zone Costs (\$1000)	\$50.00	
Work Zone Duration (days)	50	
No of Lanes Open in Each Direction During Work Zone	4	
Activity Service Life (years)	15.0	
	<b>LCCATRIANG(10,15,20)</b>	
Maintenance Frequency (years)	0	
Agency Maintenance Cost (\$1000)	0	
Work Zone Length (miles)	1.00	
Work Zone Speed Limit (mph)	35	
Work Zone Capacity (vphpl)	1500	
Time of Day of Lane Closures (use whole numbers based on a 24-hour clock)		
Inbound	Start	End
First period of lane closure	0	5
Second period of lane closure	21	24
Third period of lane closure	0	0
Outbound	Start	End
First period of lane closure	0	0
Second period of lane closure	0	0
Third period of lane closure	0	0

WSDOT Pavement Policy

<b>Rehabilitation #2</b>	Diamond Grinding and Joint Resealing	
Agency Construction Cost (\$1000)	\$2,441.00	
	<b>LCCANORMAL(2441,244.1)</b>	
User Work Zone Costs (\$1000)	\$50.00	
Work Zone Duration (days)	50	
No of Lanes Open in Each Direction During Work Zone	4	
Activity Service Life (years)	15.0	
	<b>LCCATRIANG(10,15,20)</b>	
Maintenance Frequency (years)	0	
Agency Maintenance Cost (\$1000)	0	
Work Zone Length (miles)	1.00	
Work Zone Speed Limit (mph)	35	
Work Zone Capacity (vphpl)	1500	
Time of Day of Lane Closures (use whole numbers based on a 24-hour clock)		
Inbound	Start	End
First period of lane closure	0	5
Second period of lane closure	21	24
Third period of lane closure	0	0
Outbound	Start	End
First period of lane closure	0	0
Second period of lane closure	0	0
Third period of lane closure	0	0

<b>Rehabilitation #3</b>		
Agency Construction Cost (\$1000)		
User Work Zone Costs (\$1000)	\$50.00	
Work Zone Duration (days)		
No of Lanes Open in Each Direction During Work Zone	4	
Activity Service Life (years)	15.0	
Maintenance Frequency (years)	0	
Agency Maintenance Cost (\$1000)	0	
Work Zone Length (miles)	1.00	
Work Zone Speed Limit (mph)	35	
Work Zone Capacity (vphpl)	1500	
Time of Day of Lane Closures (use whole numbers based on a 24-hour clock)		
Inbound	Start	End
First period of lane closure		
Second period of lane closure		
Third period of lane closure		
Outbound	Start	End
First period of lane closure		
Second period of lane closure		
Third period of lane closure		

WSDOT Pavement Policy

<b>Rehabilitation #4</b>		
Agency Construction Cost (\$1000)		
User Work Zone Costs (\$1000)	\$50.00	
Work Zone Duration (days)		
No of Lanes Open in Each Direction During Work Zone	4	
Activity Service Life (years)	15.0	
<b>LCCATRIANG(10,15,20)</b>		
Maintenance Frequency (years)		
Agency Maintenance Cost (\$1000)		
Work Zone Length (miles)	1.00	
Work Zone Speed Limit (mph)	35	
Work Zone Capacity (vphpl)	1500	
Time of Day of Lane Closures (use whole numbers based on a 24-hour clock)		
Inbound	Start	End
First period of lane closure		
Second period of lane closure		
Third period of lane closure		
Outbound	Start	End
First period of lane closure		
Second period of lane closure		
Third period of lane closure		

<b>Rehabilitation #5</b>		
Agency Construction Cost (\$1000)		
User Work Zone Costs (\$1000)	\$50.00	
Work Zone Duration (days)		
No of Lanes Open in Each Direction During Work Zone	4	
Activity Service Life (years)	15.0	
<b>LCCATRIANG(10,15,20)</b>		
Maintenance Frequency (years)		
Agency Maintenance Cost (\$1000)		
Work Zone Length (miles)	1.00	
Work Zone Speed Limit (mph)	35	
Work Zone Capacity (vphpl)	1500	
Time of Day of Lane Closures (use whole numbers based on a 24-hour clock)		
Inbound	Start	End
First period of lane closure		
Second period of lane closure		
Third period of lane closure		
Outbound	Start	End
First period of lane closure		
Second period of lane closure		
Third period of lane closure		

## WSDOT Pavement Policy

<b>Rehabilitation #6</b>		
Agency Construction Cost (\$1000)		
User Work Zone Costs (\$1000)	\$50.00	
Work Zone Duration (days)		
No of Lanes Open in Each Direction During Work Zone	4	
Activity Service Life (years)	15.0	
<b>LCCATRIANG(10,15,20)</b>		
Maintenance Frequency (years)		
Agency Maintenance Cost (\$1000)		
Work Zone Length (miles)	1.00	
Work Zone Speed Limit (mph)	35	
Work Zone Capacity (vphpl)	1500	
Time of Day of Lane Closures (use whole numbers based on a 24-hour clock)		
Inbound	Start	End
First period of lane closure		
Second period of lane closure		
Third period of lane closure		
Outbound	Start	End
First period of lane closure		
Second period of lane closure		
Third period of lane closure		

## Deterministic Results

Total Cost	Alternative 1: HMA		Alternative 2: PCC	
	Agency Cost (\$1000)	User Cost (\$1000)	Agency Cost (\$1000)	User Cost (\$1000)
Nominal \$	\$30,107.67	\$270,356.78	\$22,317.33	\$261,385.30
Present Value	\$18,891.08	\$240,884.78	\$19,133.72	\$238,485.30
EUAC	\$835.02	\$10,647.55	\$845.75	\$10,541.49
Lowest Present Value Agency Cost			Alternative 1: HMA	
Lowest Present Value User Cost			Alternative 2: PCC	

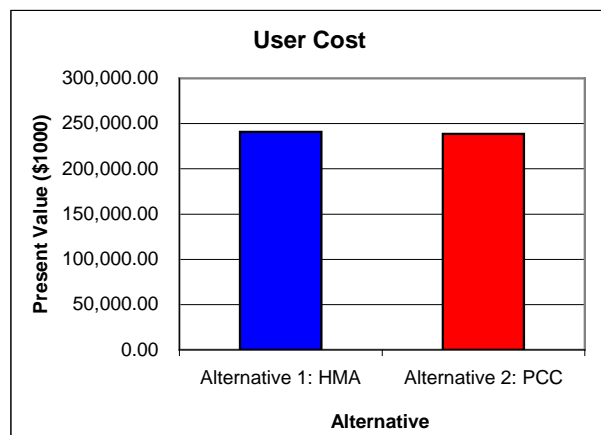
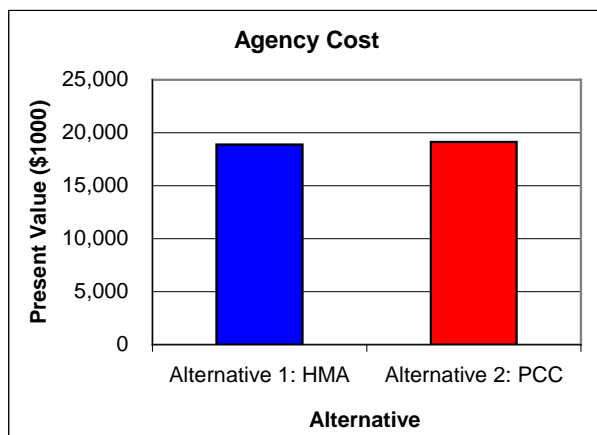

## WSDOT Pavement Policy

Based on the deterministic analysis, the PCC alternative is slightly higher for the present value of agency costs (approximately 1.3 percent higher) than the HMA alternative. For the present value of user costs, the PCC alternative is slightly lower (approximately 1.00 percent lower) than the HMA alternative. Based on total present value costs, these two alternatives would be considered equivalent (PCC is approximately 0.8 percent lower than HMA).

## Probabilistic Results

Total Cost (Present Value)	Alternative 1: HMA		Alternative 2: PCC	
	Agency Cost (\$1000)	User Cost (\$1000)	Agency Cost (\$1000)	User Cost (\$1000)
Mean	\$18,365.23	\$239,105.37	\$19,153.28	\$236,004.03
Standard Deviation	\$1,511.70	\$11,478.88	\$271.21	\$10,363.83
Minimum	\$13,083.68	\$209,885.91	\$18,553.22	\$209,779.17
Maximum	\$24,641.06	\$275,664.34	\$20,249.69	\$265,385.41

Total Cost (Present Value)	Alternative 1: HMA		Alternative 2: PCC	
	Agency Cost (\$1000)	User Cost (\$1000)	Agency Cost (\$1000)	User Cost (\$1000)
Mean	\$18,365.23	\$239,105.37	\$19,153.28	\$236,004.03
Standard Deviation	\$1,511.70	\$11,478.88	\$271.21	\$10,363.83
Minimum	\$13,083.68	\$209,885.91	\$18,553.22	\$209,779.17
Maximum	\$24,641.06	\$275,664.34	\$20,249.69	\$265,385.41

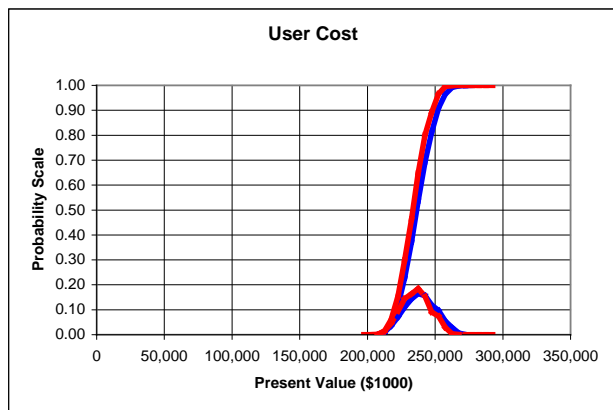
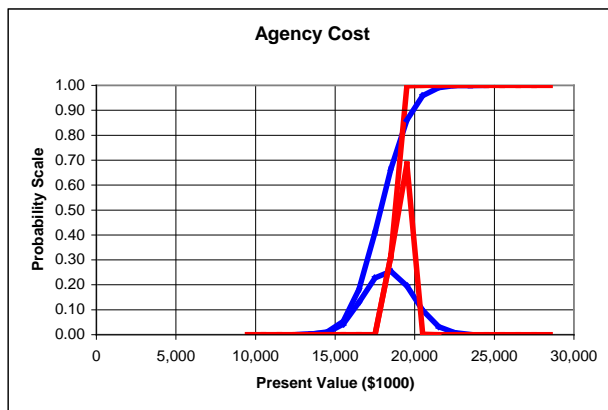

Based on the cumulative probability distributions shown above, there is an 80 percent probability that the agency costs for the HMA alternative will be less than the PCC alternative as demonstrated by the narrowness of the spread in the probabilistic analysis. The above graph also shows that there is a lower risk of cost variation with the PCC alternative. The slopes of the cumulative risk profiles shown above are similar for the user costs and only a slight difference for the agency costs. The alternative with the steeper slope would have less variability and the means being similar, would also be the preferred alternative. Therefore, in this analysis the preferred option would be the PCC alternative.





## APPENDIX 7 – PROJECT SPECIFIC DETAILS

The following are examples of project specific details that may be considered:

- Air pollution impacts. Consider if either effects on traffic or effects during production affect the project or future preservation efforts
- Non-user impacts. How are surrounding neighborhoods affected by the project? How do these impacts vary depending on the type of pavement selected? What are the impacts at the point of production?
- Haul routes through neighborhoods. Consider the impacts both during initial construction and future preservation projects.
- Future ability of plants to operate at night in urban areas and associated cost increases. Where are typical production plants located? Will night work continue to be feasible in the area of plant production or will urban growth affect this? What possible effect will urban growth have on making production plants move further away from the corridor?
- Neighborhood impacts due to trip diversion during preservation projects. When a highway closure impacts the traveling public, many will divert to other routes to avoid delays. These diversions have associated costs, in and of themselves. Some of the costs come from backups and delays (user impacts) on these diversion routes; some of the costs come from impacts to neighborhoods, through increased traffic, noise, congestion, air pollution, safety and accident risks. Consider the level of user delays and the likelihood that diversions will occur and the level of impact these diversions could have on non-highway users.
- Business impacts due to reduced or restricted access. This impact happens both due to direct impacts to users and to impacts due to diversion. The magnitude grows as an area urbanizes and increases the number of businesses that stay open for extended (mostly nighttime) hours of operation. Diversion through a neighborhood with extensive commercial business can greatly impact those businesses.
- Effect of nighttime noise variances and risk of approval of noise variances. These two items tie in with the item noted above. As urban areas grow, nighttime noise variances become more difficult to obtain and more restrictive in their limitations. Review the corridor in question and the expected growth projections, to develop an idea of the risk associated with this non-user impact. Noise restrictions can limit hours of operations to the point of preventing work, or they can restrict noise levels below that achievable by state of the practice construction equipment. Noise restrictions apply also to vibration and noise generated by vibratory equipment and these restrictions can prevent the use of particular equipment within selected urban corridors. A single resident affected by nighttime noise can and has effectively shut down projects, forcing a move to day work and created huge impacts on highway users through delay and impacts.
- Noise
  - Noise walls. Evaluate whether the corridor already has noise walls or is expected to have noise walls by the time of the project, and the impacts having or not having the walls might have on non-users/residents, both for construction noise and pavement noise
  - Haul through neighborhoods at night. Haul through neighborhoods at night (and if you are hauling, you are traveling through *someone's* neighborhood) should be considered as an impact. Sparsely populated areas will obviously have a smaller impact due to the noise of hauling vehicles than densely packed urban areas.

## WSDOT Pavement Policy

- Noise from diverted traffic and other impacts. Diverted traffic must drive through someone's neighborhood to get to where they are going. At night, diverted traffic, especially involving large trucks, can have a significant noise impact on neighborhoods.
- Noise generation during preservation projects. When preservation projects are performed on any pavement, noise is generated and its impacts on the local community must also be considered, in addition to the impact of the noise from the initial construction.
- Safety.
  - Public exposure to traffic control during lane closures.
  - Work exposure to traffic during lane closures.
  - Lane closures are a safety risk factor for both workers and the traveling public. Limited vision, nighttime lighting, temporary traffic control and other factors increase the risk of accidents to both motorists and to workers within the work zone. Evaluate the risk to both, given the nature of the corridor, the ADT, the degree of urbanization and the complexity of the facility.
  - Safety risks associated with maintenance by state forces between preservation projects.
- Pavement type continuity within a corridor (similar to architectural choices for structures and wall-types within a corridor and landscape architectural choices for continuity within a corridor). It is generally not desirable to switch pavement types over relatively short stretches of highway. Maintenance needs change for each given pavement type, as do preservation needs. Further, the change in pavement type impacts the public in various ways, including aesthetics.
- Environmental effects.
  - Runoff temperature due to heating effects depending on pavement type. Evaluate in conjunction with design of the storm sewer system.

## **APPENDIX 8 – WSDOT PAVEMENT TYPE SELECTION COMMITTEE AND SAMPLE MEMORANDUM**

**The Pavement-Type Selection Committee is composed of:**

1. Chief Engineer, Assistant Secretary of Engineering and Regional Operations
2. State Construction Engineer
3. State Design Engineer
4. Director Capital Program Development and Management
5. Regional Administrator of the Region in which the project under consideration is located



## Memorandum

April 16, 2009

TO: L. Laird, 47315

FROM: Jeff Carpenter, 47365  
State Construction Engineer

SUBJECT: Pavement Type Selection Process

When the pavement type selection has been completed and forwarded to the State Materials Laboratory Pavement Division will formulate the Pavement Type Selection Committee (referred to as the Committee) Approval Letter and request that each member of the Committee sign and forward the letter on to the next member. The Committee is not required to convene if the life cycle cost analysis between the alternatives is greater than 15 percent and the recommendations are acceptable to both the Region and the State Materials Laboratory Pavements Division. The Approval Letter shall provide the necessary documentation that supports the Committee's selection of the pavement type.

Projects to be reviewed shall be distributed to the Committee members for approval (see attached example of Approval Letter). Based on this review and obtaining consensus from the Committee, the Pavement Division will either process the Approval Letter, take appropriate action to obtain consensus, or convene the Committee.

In order to expedite the required time and expended level of effort for the review of pavement type selection projects, the following procedure is recommended:

1. The Committee should convene if the pavement type recommended by the Region is contrary to pavement design and project specific detail recommendations. The pavement design and project specific detail recommendations shall be subject to the review of the Pavement Division or any member of the Committee. Under these circumstances it shall be the responsibility of the Pavements Division or the Committee member to formulate, in writing, why the selected pavement type is not appropriate and distribute his/her rationale to all members. If all members agree with the recommendations a meeting will not be necessary, otherwise, the Committee should convene.
2. The Committee should convene at the request of any member.

TEB: jsu



PAVEMENT TYPE SELECTION

SR-3  
Luoto Road to SR-305  
MP 48.90 to MP 53.00

The Pavement Type Selection Committee has completed its review of the pavement type selection for the project SR-3 Luoto Road to SR-305, MP 48.90 to MP 53.00.

The project consists of constructing the final two lanes of the ultimate four-lane facility from Luoto Road to SR-305.

The pavement design analysis resulted in both pavement types (HMA and PCC) being viable. In the life cycle cost analysis, one PCC alternative was compared to one HMA alternative. In the life cycle cost analysis of the two alternatives, there is a cost advantage in the use of HMA over PCC of greater than 15 percent. The Committee approves the use of HMA on this project.

**The Pavement Type Selection Committee**

---

Chief Engineer  
Assistant Secretary of Engineering and  
Regional Operations

---

State Design Engineer

---

State Construction Engineer

---

Director Capital Program Development and  
Management

---

Olympic Region Administrator

JU:ck



## **APPENDIX 9 - BASIS OF WSDOT PAVEMENT DESIGN POLICY FOR DESIGN BUILD PROJECTS**

### **INTRODUCTION**

WSDOT's pavement design policy is a product of experience, research findings (state, national and international) and various analyses. The policy is based upon pavement design practices that WSDOT has found to produce serviceable and cost effective pavements for the conditions in Washington State. Generally, these practices follow conventional pavement design procedures. Practices that have shaped WSDOT's pavement design policy include:

- Designing pavement structures for long-life (50 years or more).
- Designing HMA pavement to ensure that cracking occurs from the top down instead of from the bottom up,
- Reusing the existing pavement structure as much as practical when rehabilitating an existing pavement, and
- Incorporating pavement preservation at both the capital project level as well as the state forces maintenance level.

The purpose of this paper is to briefly explain the basis of WSDOT's Pavement Design Policy and how this fits into the context of design-build projects.

### **WSDOT PAVEMENT DESIGN PROCEDURES**

For most state highway agencies, including WSDOT, the current primary pavement design tool is *the 1993 AASHTO Guide for Design of Pavement Structures (1993 AASHTO Guide)*. While use of this empirical method has been successful, it has several acknowledged shortcomings including being based on a limited number of pavement sections at one location, one climate, one set of materials and truck loads from the late 1950s. It is a testament to this model's robustness and the ingenuity of those who have worked on it that it can still be used to design reasonable pavement structures. Most users of the *1993 AASHTO Guide* recognize its shortcomings and have developed workarounds to get results that match field performance.

## WSDOT Pavement Policy

*AASHTOWare Pavement ME Design (AASHTOWare)* has been proposed as the next generation of pavement design software. With its basis in empirical field and laboratory performance combined with mechanistic principles, the resulting designs are assumed to produce better thickness estimates than traditional empirical designs. While *AASHTOWare* is, in many respects, a much more sophisticated and detailed design approach, it does not model all the desired distress types and is unable (due to software bugs or otherwise) to predict others adequately for WSDOT. The major distress on WSDOT asphalt pavements is top-down alligator cracking which is not modeled in *AASHTOWare*. Likewise, the major distress on WSDOT Jointed Plain Concrete Pavement (JPCP), multiple cracked a panels, rutting/wear from studded tires and longitudinal cracking are not modeled in *AASHTOWare*.

Ultimately, it is historical performance that provides the missing information and the assurance that model outputs are likely to be achieved during actual performance—for both *AASHTOWare* and the current WSDOT design approach. Knowledge of this led to the development of a pavement structural thickness design catalog for WSDOT based on a combination of prior models, new models (including *AASHTOWare* where applicable) and historical performance (*Li et al, 2010*). The resulting design catalog has been officially adopted by WSDOT and is included in this document.

WSDOT currently uses Darwin 3.01 (based on the *1993 AASHTO Guide*) as well as the new structural thickness catalog developed as a guide for regional designers. Other pavement design procedures have not been calibrated for performance and conditions experienced in Washington.

## **DESIGN-BUILD PROJECT PAVEMENT DESIGN PROCEDURES**

In Washington, the specified pavement thickness is predicated on providing adequate pavement thickness to accommodate traffic, climate and future studded tire wear. On past design-build contracts, WSDOT has specified the pavement layer thicknesses. The question asked by design builders is “why can’t an alternate design sections utilizing the *AASHTOWare* or another pavement design procedure be proposed on design build projects?”

Although WSDOT sees the *AASHTOWare* as a potentially useful tool to model pavement in the future, WSDOT currently does not use the software. Without the software, WSDOT can only evaluate the design using its present tools, WSDOT’s design catalog and the *1993 AASHTO Guide*. Proposals relying on *AASHTOWare* often include design elements that are not adequately



## WSDOT Pavement Policy

modeled using the *1993 AASHTO Guide*. These proposals cannot be approved since WSDOT has no way to determine if they are adequate.

One of the reasons that WSDOT has not adopted *AASHTOWare* is the significant effort required to calibrate it to local conditions. The work required with local calibrations is tedious requiring 6 months to complete a single calibration. Software upgrades are released at least once a year requiring additional calibration. Without local calibration, the software may not provide an adequate pavement design. Currently design-builders do not use local calibration when they submit Alternate Technical Concepts (ATC) using *AASHTOWare*. Since there is no local calibration, ATC's developed using *AASHTOWare* will likely result in a difference between predicted and actual performance. For a design-builder to use local calibration with the software, WSDOT would need to do the local calibration and provide the calibration constants to the design-builder.

*AASHTOWare* does not currently model important distress types for Washington pavement (top-down alligator cracking in HMA pavement, multiple cracks in a panel, rutting/wear from studded tires and longitudinal cracking in portland cement concrete pavement (PCCP)). Without a way to model these distress types, the software will not be able to accurately predict the performance life of pavement in Washington.

WSDOT is not alone in providing the pavement design for design-build projects. In a report entitled *Best Practices in Pavement Design for Design-Build Projects*,<sup>1</sup> Minnesota Department of Transportation learned that specifying pavement types and pavement thicknesses is a common practice with state agencies (*MnDOT, 2014*). Some state agencies have allowed design-builders the ability to perform some aspects of pavement design. However, in all cases, the state agency provides approval for the requests and designs typically follow individual state minimum standards.

The pavement design requirements in the WSDOT Pavement Policy result in pavements that perform well in Washington. The risk that pavement designed in accordance with the pavement policy will not perform well over the pavement's life is minimal. Alternate designs proposed by the design-builder do not have the performance history of WSDOT designs. Designs that work well in other states also may not work well in Washington. Most of the risk in a pavement design depends on how well the pavement performs over its life. New pavement sections are a

## WSDOT Pavement Policy

major investment for WSDOT and are expected to have a high reliability of lasting 50 years or more. This is most important in heavily congested corridors because early repair or reconstruction also affects the public. WSDOT cannot pass the long-term performance risk onto the design-builder. If a pavement does not perform well, the cost to fix it will be WSDOT's. Essentially, WSDOT owns the long-term risk when it comes to the long-term performance of pavements.

### WSDOT PAVEMENT TYPES FOR DESIGN BUILD CONTRACTS

Design Build contracts constructed to date have mostly been PCCP or HMA reconstruction (Figure A9.1), however, there have been some opportunities for alternative pavement designs such as crack, seat and overlay, PCCP intersections for reconstruction and mill and fill or overlay for pavement rehabilitation work. As an example, during the proposal period a design-builder submitted an ATC to allow an unbonded overlay on a project with heavy interstate traffic. The unbonded overlay would replace PCCP reconstruction required by the Request for Proposal. The design-builder's proposal reduced construction cost and saved time while still meeting WSDOT's design criteria. Based on the recommendation of the State Pavement Office WSDOT approved the ATC.

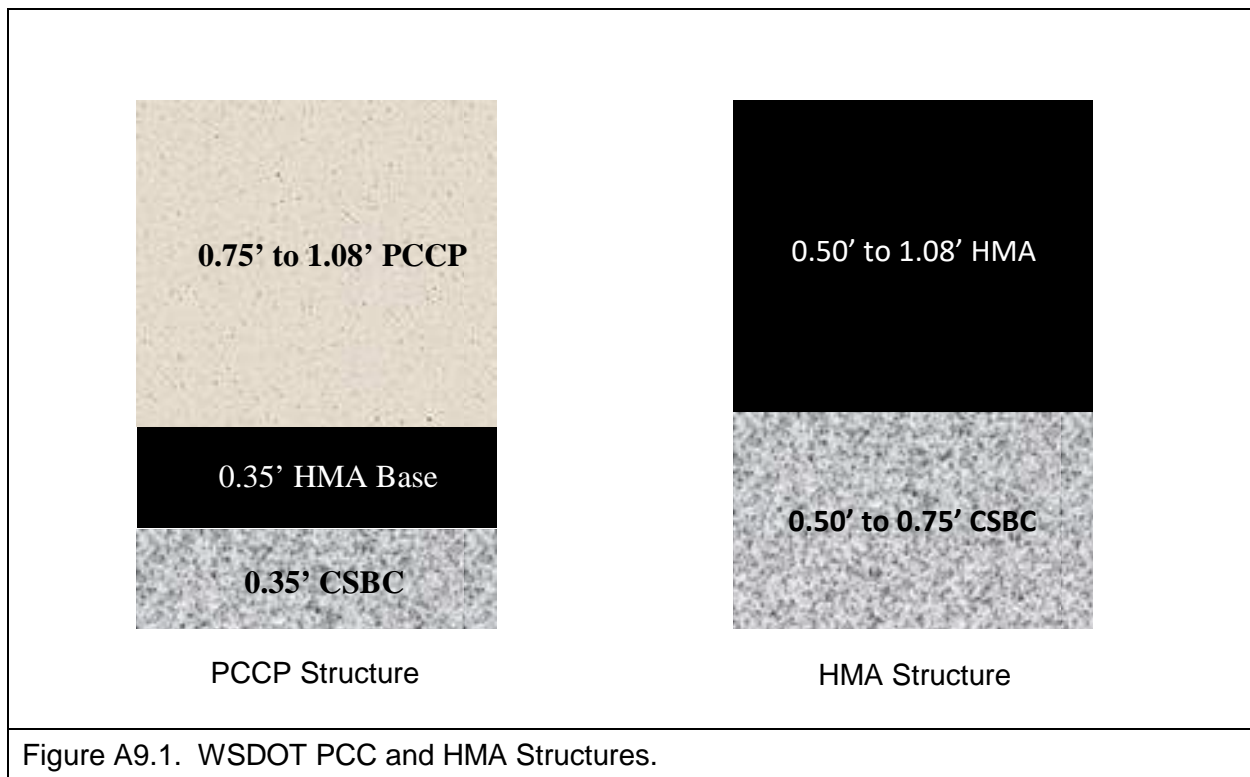

**PCCP**

WSDOT PCCP design policy grew out of the historical performance of PCCP in Washington. Paving concrete used in Washington has historically performed well structurally and has not suffered from any significant durability problems. The limiting failure mechanisms have therefore been those that do not involve the concrete material itself such as faulting, roughness and studded tire wear. The following describes the strategies used by WSDOT for each design element to design long life PCCP.

**PCCP Thickness Design**

WSDOT designed the PCCP constructed during the 1960’s and 1970’s as part of the original interstate construction with an 8 or 9 inch thickness. Although these pavements performed well they are under structured for today’s truck and bus traffic. Pavements constructed today will carry 3 to 5 times the number of ESALs carried by the original pavement over the next 50 years (Table A9.1). The increased ESALs will require additional pavement thickness to prevent cracking over a 50-year pavement life.

<b>Table A9.1 Past and Future ESALs on Interstate PCCP</b>				
Route	Approx. Milepost	ESALs Since Const. (millions)	50-year Future ESALs (millions)	ESAL Increase (factor)
I-5	15	43	240	5.6
I-5	130	49	198	4.0
I-5	145	41	163	4.0
I-5	260	19	68	3.5
I-82	50	15	70	4.8
I-90	45	24	112	4.7

The primary design tool for WSDOT structural design is the design catalogue in Table 5.1 contained in this policy document. The *1993 AASHTO Guide* is the basis for the table; however, the Mechanistic-Empirical Pavement Design Guide<sup>1</sup> (MEPDG version 1.0) along with WSDOT pavement historical data and experience was used in the development and validation of the design tables. The *1993 AASHTO Guide* results in PCCP that are thicker than required for

---

<sup>1</sup> The Mechanistic-Empirical Pavement Design Guide is the precursor to *AASHTOWare*.

## WSDOT Pavement Policy

Washington conditions which are accounted for in the design table by providing more reasonable thicknesses (Li et al, 2010). Table A9.2 compares PCCP thicknesses from Table 5.1 to thicknesses computed using the 1993 AASHTO Guide.

<b>Table A9.2 PCCP thickness – WSDOT Pavement Policy vs. 1993 AASHTO Guide</b>		
<b>Design Period ESALs</b>	<b>PCCP Thickness from Table 5.1 of WSDOT Pavement Policy (ft.)</b>	<b>PCCP Thickness from 1993 AASHTO Guide (ft.)</b>
< 5,000,000	0.67	0.73
5,000,000 to 10,000,000	0.75	0.86
10,000,000 to 25,000,000	0.83	1.00
25,000,000 to 50,000,000	0.92	1.12
50,000,000 to 100,000,000	1.00	1.24
100,000,000 to 200,000,000	1.08	1.38

WSDOT new PCCP design thicknesses are comparable to other states that design long life pavements. An FHWA Techbrief (Tayabji and Seungwook, 2007) which compared long life pavement designs for Illinois, Minnesota, Texas and Washington showed similar thicknesses for all four states. The techbrief described Illinois long life pavement as 14 inch thick continuously reinforced concrete pavement (CRCP) over a 4 to 6 inch HMA stabilized base with a 30 to 40 year design life. Minnesota uses a design life of 60 years to design 11.5 to 13.5 inch thick doweled JPCP over aggregate base. The techbrief did not provide a thickness for Texas long life PCCP but it was stated that Texas uses the 1986 AASHTO procedure to design CRCP. The 1986 AASHTO procedure is similar to the *1993 AASHTO Guide* used by WSDOT to develop the design table making it likely that Texas designs PCCP of similar thickness to WSDOT. WSDOT's maximum PCCP thickness of 13 inches for its highest volume routes is similar to those used by these other states.

## **PCCP Materials**

In order for a pavement to perform over a 50-year life, all components of the design need to be able to perform for 50 years (Jackson et al, 2014). This requires that materials used in the construction of the pavement be able to reliably last 50 years. Specific requirements for materials that allow a 50-year life are detailed as follows:

### ***Portland Cement Concrete***

PCCP in Washington have not suffered from significant durability problems. Damage caused by reactive aggregates and D cracking can limit pavement life in other parts of the country. The WSDOT Standard Specification requires the use of high quality aggregates and mitigation for alkali silica reactive aggregates. This and an ample supply of high quality aggregates allows the production of concrete that is capable of performing for 50 years or more.

### ***Dowel Bars***

A long pavement life necessitates that dowel bars be able to resist corrosion. Inspection of epoxy coated dowel bars removed from in service pavements revealed that they are susceptible to corrosion in Washington conditions. In order to achieve a long life WSDOT requires stainless steel or equivalent dowels in all new PCCP. Epoxy coated dowel bars are allowed in applications that do not have as long of a life such as dowel bar retrofits and replacing damaged panels in an existing PCCP.

### **PCCP Base**

A primary form of distress on PCCP constructed as part of the original interstate system in Washington was joint faulting (Jackson et al. 2014). WSDOT overlaid substantial mileage of the original PCCP with HMA due to rough ride caused by faulting. Significantly more miles of faulted PCCP have been retrofitted with dowel bars and diamond ground. To prevent faulting and migration of fines under PCCP panels, WSDOT initiated the policy to use only HMA base under PCCP on high volume roadways. HMA prevents faulting, pumping and migration of fines by improving load transfer across joints, blocking the migration of fines underneath the PCCP panels and being resistant to erosion. Pavement performance data, research and WSDOT experience shows that an HMA base has outperformed other base material for PCCP. Performance on WSDOT highways shows that other base types were not be able to perform over a 50-year pavement life for the following reasons.

## WSDOT Pavement Policy

- **Granular bases** used in Washington have historically been susceptible to pumping and the migration of fines resulting in faulting and premature panel failure (Meunch et al, 2010).
- **Cement Treated Base (CTB)** -PCCP placed on CTB have performed poorly relative to other base types in Washington. Erosion of the CTB results in voids under the panel that can quickly lead to panel failure (Meunch et al, 2010).
- **Asphalt Treated Base (ATB)** has been the best performing base but is susceptible to stripping because of the low asphalt content in the mix. The stripping leads to loss of support and faulting (Meunch et al, 2010). ATB tended to be one of the best performing bases nationally and in Washington. The increased asphalt content in dense graded HMA will greatly reduce the risk of stripping further increasing the performance of PCCP for a small increase in cost.
- **Lean Concrete Base (LCB)** has had limited use in Washington State (its use was the SPS-2 site on US 395) but has not performed well either nationally or within Washington State.
- **Permeable bases** have performed poorly nationally and are no longer recommended (ACPA, 2007). Subsurface drainage issues are always considered by WSDOT but this solution is not long term.

## HOT MIX ASPHALT PAVEMENT

WSDOT design HMA pavement for a 50 year life. This requires a pavement structure that can carry the loads it will experience over 50 years and materials can resist stripping and other types of disintegration over the pavement life. Periodic surface renewals will be necessary to restore the pavement surface.

### HMA Pavement Thickness Design

WSDOT designs HMA pavement based on the concept that cracking in thicker HMA sections will primarily be top down. Correcting surface distress on these thicker HMA pavements before it propagates into the lower layers preserves the underlying structure allowing the pavement to have a long life. Designing HMA pavements for a 50-year design life results in relatively thick HMA pavement structure that is adequate to carry the loads it will experience over the long pavement life. Preserving this thick HMA pavement involves milling off the cracked top lift of HMA and

## WSDOT Pavement Policy

inlaying with an equal thickness of new HMA. It is WSDOT's experience that these practices results in HMA pavements than can perform well for more than the 50-years design life and that are cost effective.

### **HMA Pavement Materials**

In order to achieve a long life the HMA base layers must be resistant to moisture damage. National research has found that smaller nominal maximum aggregate size gradations are less permeable for a given density than larger NMAS aggregates (Mallick et al, 2003). To reduce the likelihood of moisture damage WSDOT constructs all lifts using either  $\frac{3}{8}$  or  $\frac{1}{2}$  inch NMAS gradations. Larger NMAS mixes are not allowed by WSDOT even though they are included in the WSDOT Standard Specifications largely due to low density and water susceptibility issues.

### **HMA Pavement Base**

WSDOT uses crushed surfacing base course under HMA pavement in areas that will be less than  $\frac{1}{2}$  the frost depth from the pavement surface. Crushed surfacing top course has been found to be susceptible to frost heave and is not used less than  $\frac{1}{2}$  the depth of maximum freezing.